



Cypress College

Catalog

2017–2018

9200 Valley View Street
Cypress, California 90630
(714) 484-7000
www.CypressCollege.edu

Volume Fifty-Two
Published Annually July, 2017
Price \$8 per copy (\$10 mailed)

Cypress College is accredited by the Accrediting Commission for Community and Junior Colleges of the Western Association of Schools and Colleges, (10 Commercial Blvd., Ste. 204, Novato, CA 94949, 1-415-506-0234, Fax 1-415-506-0238, <http://www.acscwasc.org/index.htm>), an institutional accrediting body recognized by the Commission on Recognition of Postsecondary Accreditation and the U.S. Department of Education.

The College Catalog is a publication of the Cypress College Office of Instruction

Table of Contents

| | |
|---|-------------------|
| Academic Calendar | 3 |
| About Cypress College | 4 |
| Admissions Requirements | 6 |
| Registration | 7 |
| Academic Policies | 9 |
| Distance Education Program | 26 |
| Instructional Support Services | 26 |
| Special Programs | 28 |
| Student Support Services | 32 |
| Campus Life | 39 |
| Administrative Procedures | 41 |
| Programs of Study | 48 |
| Graduation/Educational Options | 52 |
| Programs/Course Descriptions | 73 |
| Administration/Organizational Structure | 310 |
| Faculty | 317 |
| Quick Guide to Help You | 328 |
| Index | 330 |
| Campus Map | Inside Back Cover |

*Academic Calendar 2017–2018

Cypress College operates on a 16-week semester

2017 Fall Semester — August 28–December 16, 2017

August 28 First Day of Instruction
 September 4 Legal Holiday — Labor Day
 November 10 Legal Holiday — Veterans' Day
 November 23, 24, 25, 26 Legal Holiday — Thanksgiving Recess
 December 16 End of Fall Semester
 December 17, 2017–January 28, 2018 Academic Recess between Semesters

2018 Spring Semester — January 29, 2018–May 26, 2018

January 15 Martin Luther King Holiday
 January 29 First Day of Instruction
 February 16 Legal Holiday — Lincoln's Birthday (No classes Saturday 17th or Sunday 18th)
 February 19 Legal Holiday — Presidents' Day
 March 25–29 Spring Recess (No classes Saturday 30th or Sunday 1st)
 March 29 Campus Closed
 May Commencement
 May 26 End of Spring Semester
 May 28 Observed Legal Holiday — Memorial Day

2018 Summer Session — to be announced

*Dates and deadlines are subject to change.

July 2017–June 2018

2017

2018

| JULY | | | | | | | AUGUST | | | | | | | SEPTEMBER | | | | | | | |
|------|----|----|----|----|----|----|--------|----|----|----|----|----|----|-----------|----|----|----|----|----|----|---|
| S | M | T | W | T | F | S | S | M | T | W | T | F | S | S | M | T | W | T | F | S | |
| | | | | | | 1 | | | 1 | 2 | 3 | 4 | 5 | | | | | | | 1 | 2 |
| 2 | 3 | 4 | 5 | 6 | 7 | 8 | 6 | 7 | 8 | 9 | 10 | 11 | 12 | 3 | 4 | 5 | 6 | 7 | 8 | 9 | |
| 9 | 10 | 11 | 12 | 13 | 14 | 15 | 13 | 14 | 15 | 16 | 17 | 18 | 19 | 10 | 11 | 12 | 13 | 14 | 15 | 16 | |
| 16 | 17 | 18 | 19 | 20 | 21 | 22 | 20 | 21 | 22 | 23 | 24 | 25 | 26 | 17 | 18 | 19 | 20 | 21 | 22 | 23 | |
| 23 | 24 | 25 | 26 | 27 | 28 | 29 | 27 | 28 | 29 | 30 | 31 | 24 | 25 | 26 | 27 | 28 | 29 | 30 | | | |
| 30 | 31 | | | | | | | | | | | | | | | | | | | | |

| OCTOBER | | | | | | | NOVEMBER | | | | | | | DECEMBER | | | | | | | | | |
|---------|----|----|----|----|----|----|----------|----|----|----|----|----|----|----------|----|----|----|----|----|----|--|---|---|
| S | M | T | W | T | F | S | S | M | T | W | T | F | S | S | M | T | W | T | F | S | | | |
| | | | | | | | | | | | | 1 | 2 | 3 | 4 | | | | | | | 1 | 2 |
| 1 | 2 | 3 | 4 | 5 | 6 | 7 | 5 | 6 | 7 | 8 | 9 | 10 | 11 | 3 | 4 | 5 | 6 | 7 | 8 | 9 | | | |
| 8 | 9 | 10 | 11 | 12 | 13 | 14 | 12 | 13 | 14 | 15 | 16 | 17 | 18 | 10 | 11 | 12 | 13 | 14 | 15 | 16 | | | |
| 15 | 16 | 17 | 18 | 19 | 20 | 21 | 19 | 20 | 21 | 22 | 23 | 24 | 25 | 17 | 18 | 19 | 20 | 21 | 22 | 23 | | | |
| 22 | 23 | 24 | 25 | 26 | 27 | 28 | 26 | 27 | 28 | 29 | 30 | 24 | 25 | 26 | 27 | 28 | 29 | 30 | | | | | |
| 29 | 30 | 31 | | | | | | | | | | | | | | | | | | | | | |

| JANUARY | | | | | | | FEBRUARY | | | | | | | MARCH | | | | | | | | | |
|---------|----|----|----|----|----|----|----------|----|----|----|----|----|----|-------|----|----|----|----|----|----|---|---|---|
| S | M | T | W | T | F | S | S | M | T | W | T | F | S | S | M | T | W | T | F | S | | | |
| | | | | | | | | | | | | 1 | 2 | 3 | | | | | | | 1 | 2 | 3 |
| 1 | 2 | 3 | 4 | 5 | 6 | | 4 | 5 | 6 | 7 | 8 | 9 | 10 | 4 | 5 | 6 | 7 | 8 | 9 | 10 | | | |
| 7 | 8 | 9 | 10 | 11 | 12 | 13 | 11 | 12 | 13 | 14 | 15 | 16 | 17 | 11 | 12 | 13 | 14 | 15 | 16 | 17 | | | |
| 14 | 15 | 16 | 17 | 18 | 19 | 20 | 18 | 19 | 20 | 21 | 22 | 23 | 24 | 18 | 19 | 20 | 21 | 22 | 23 | 24 | | | |
| 21 | 22 | 23 | 24 | 25 | 26 | 27 | 25 | 26 | 27 | 28 | 25 | 26 | 27 | 28 | 29 | 30 | 31 | | | | | | |
| 28 | 29 | 30 | 31 | | | | | | | | | | | | | | | | | | | | |

| APRIL | | | | | | | MAY | | | | | | | JUNE | | | | | | | | | | |
|-------|----|----|----|----|----|----|-----|----|----|----|----|----|----|------|----|----|----|----|----|----|--|--|---|---|
| S | M | T | W | T | F | S | S | M | T | W | T | F | S | S | M | T | W | T | F | S | | | | |
| | | | | | | | | | | | | 1 | 2 | 3 | 4 | 5 | | | | | | | 1 | 2 |
| 1 | 2 | 3 | 4 | 5 | 6 | 7 | 6 | 7 | 8 | 9 | 10 | 11 | 12 | 3 | 4 | 5 | 6 | 7 | 8 | 9 | | | | |
| 8 | 9 | 10 | 11 | 12 | 13 | 14 | 13 | 14 | 15 | 16 | 17 | 18 | 19 | 10 | 11 | 12 | 13 | 14 | 15 | 16 | | | | |
| 15 | 16 | 17 | 18 | 19 | 20 | 21 | 20 | 21 | 22 | 23 | 24 | 25 | 26 | 17 | 18 | 19 | 20 | 21 | 22 | 23 | | | | |
| 22 | 23 | 24 | 25 | 26 | 27 | 28 | 27 | 28 | 29 | 30 | 31 | 24 | 25 | 26 | 27 | 28 | 29 | 30 | | | | | | |
| 29 | 30 | | | | | | | | | | | | | | | | | | | | | | | |

Cypress College has made every reasonable effort to determine that everything stated in this Catalog is accurate. This publication is prepared in advance of the time period it covers; therefore, changes in courses and programs offered, together with other matters contained herein, are subject to change without notice by the administration of Cypress College.

Cypress College

VISION STATEMENT

A premier learning community recognized for supporting student success and enriching society.

MISSION STATEMENT

Cypress College enriches students' lives by providing premier educational opportunities including transfer to four-year institutions, associate degrees, certificates and a baccalaureate degree. The college offers comprehensive career technical educational programs, basic skills and lifelong learning. Multiple educational-delivery methods meet the varied needs of our students. The College is dedicated to supporting the success of our students, fostering diversity, enriching society, and contributing to the economic development of our community and beyond.

EXCELLENCE IN EDUCATION

Cypress College emphasizes education for the individual student. Excellence of instruction and individualized learning laboratories enhance the possibility for students to achieve their highest potential. In addition, a staff of tutors and full-time counselors provides instructional support and extensive guidance information to aid students in their choice of programs and classes. For the student who plans to complete a Baccalaureate degree, the college provides a smooth transition from high school to colleges and universities.

Numerous occupational programs are available for the student who desires preparation for immediate employment. Each occupational program is planned with the aid of a local advisory committee to insure relevance to changing career opportunities in each area of employment.

The College is composed of twelve major instructional buildings located on a 110-acre site. The campus buildings contain conventional classrooms as well as laboratory facilities for science, art, computer technology, photography, automotive services, dental clinic, mortuary science, physical education and other specialized programs. The college's Educational Services provide opportunities for students with disabilities to be fully integrated into various college programs.

In addition to these instructional facilities, the campus is provided support services by a bookstore, and food service centers. There are nine parking lots with an aggregate of 4,000 parking spaces designed to service students and staff, with an appropriate number of spaces reserved for individuals with disabilities.

Cypress College serves the educational needs of its entire community by providing a variety of occupational programs, transfer programs, and special interest classes. The College offers something for everyone, regardless of the student's individual background or educational goals. Since opening in 1966, Cypress' population has grown from an original enrollment of 1,200 to a student population of almost 15,000.

CORE VALUES

Cypress College is committed to:

- Excellence:** quality and high standards in instruction and student services, enhanced by professional growth for faculty and staff.
- Integrity:** an ethical standard of honesty, fairness, accountability, and trust.
- Collegiality:** teamwork, collaboration, communication, courtesy and respect both on campus and with the surrounding community.
- Inclusiveness:** a community that embraces diversity, fosters individuality, provides an accessible, supportive climate, and encourages a variety of perspectives and opinions.

STRATEGIC PLAN DIRECTIONS

Direction 1: The District will annually improve the rates of completion for degrees, certificates, diplomas, transfers, transfer-readiness requirements, and courses.

Direction 2: The District will annually make progress toward eliminating the documented achievement gap among race/ethnicity groups.

Direction 3: The District will annually improve the success rate for students moving into:

- The highest level possible credit basic skills courses in mathematics, English, and English as a Second Language from noncredit basic skills instruction in the same discipline
- College-level courses in mathematics, English, and English as a Second Language from credit or noncredit basic skills instruction in these disciplines and
- The next higher course in the sequence of credit or noncredit basic skills courses in mathematics, English, and English as a Second Language

Direction 4: The District will implement best practices related to planning, including transparent decision-making processes, support of strategic and comprehensive planning activities at campus and district levels, and the allocation of resources to fund planning priorities.

Direction 5: The District will develop and sustain collaborative projects and partnerships with the community's educational institutions, civic organizations, and businesses.

CYPRESS COLLEGE INSTITUTIONAL LEARNING OUTCOMES

Approved by Academic Senate on May 11, 2012, and by the President's Advisory Council on May 18, 2012

Students leaving Cypress College will demonstrate common learning outcomes according to the pathway they have chosen: transfer, degree, GE certification; career and technical certification and/or licensure; and/or life-long learning. These Institutional Learning Outcomes encompass the whole student experience. Cypress College uses these ILOs to connect or link student learning outcomes at the course and program levels in instruction, student support services, and learning support services to the overall mission of the college and the success of our students.

Pathway I: Associate Degree and/or CSU/IGETC Transfer Curriculum

I. Breadth of Knowledge, Experiences, and Skills

- Humanities and the Arts: aesthetic awareness, critical analysis, creativity, human reason and culture
- Science, Technology, Engineering, and Mathematics: scientific principles, scientific method, mathematical systems
- Social Sciences: cultural competence, global perspective, human experience
- Physical Education: fitness, health and nutrition, movement competence

II. Communication

- Reading: comprehending, interpreting, and/or evaluating various written information
- Writing: communicating thoughts, ideas, information and messages in appropriate writing
- Listening: perceiving and responding to verbal and/or nonverbal messages
- Communicating: organizing ideas and communicating verbal and/or nonverbal messages appropriate to audience in group setting

III. Critical Thinking and Information Competency

- Analysis: application of rules and principles to new situations, use of logic to draw conclusions, differentiation of facts/inferences/assumptions/conclusions
- Computation: using basic numerical concepts, tables/graphs/charts, and basic geometrical shapes
- Research: effectively and ethically acquiring information and data through print and electronic technology, and then organizing, analyzing, evaluating, synthesizing, and communicating information
- Problem-Solving: defining a problem, creating a plan of action to resolve problem, executing and evaluating the effectiveness of the plan

IV. Personal, Academic, and Professional Development

- Self-Integration: Understanding the person as an integrated physiological, social, and psychological being
- Personal Responsibility: Self-assessment, development of skills, identifying values and developing goals for personal, academic, and professional growth and life-long independent learning

- Global Citizenship: Understanding the interconnection between current events, ethics, and personal and societal choices within our world

Pathway II: Career and Technical Education Certification

I. Breadth of Knowledge, Competencies, and Skills

- Acquisition of a specified set of principles and skills required for a particular profession, industry, or employment opportunities
- Achievement of the necessary competencies to enter a particular employment field

II. Communication in a Particular Field or Employment

- Comprehending, interpreting, and/or evaluating written information
- Communicating thoughts, ideas, information, and messages in writing appropriate to a career
- Communicating ideas and verbal and/or nonverbal messages in the language, mode, and/or medium of a particular field according to industry standards

III. Analytical Thinking, Problem-Solving, and Information Competency

- Diagnosis, analysis, and application of rules and principles of a particular profession according to professional or industry standards
- Use of numerical concepts, tables/graphs/charts, and numerical principles for computation in a particular field
- Defining a problem, creating a plan of action to resolve problem, executing, and evaluating the effectiveness of the plan in a particular field of employment
- Effectively and ethically acquiring information and data through print and electronic technology, and then organizing, analyzing, evaluating, synthesizing, and communicating information
- Effectively, efficiently, and ethically utilizing current and learning emerging technologies of a particular field of employment

IV. Personal, Academic, and Professional Development

- Self-assessment, development of skills, identifying values and developing goals for personal, academic and professional growth, career resilience, and life-long independent learning
- Demonstration of professional and ethical responsibilities of the individual
- Awareness of additional educational and career opportunities within a particular field and an understanding of the life-long learning requirements of the field

Pathway III: Personal, Academic, and Professional Development

Personal Responsibility

Self-assessment, identification and development of skills and goals for personal, academic, and professional growth and life-long independent learning

Admissions Requirements

Admission to Cypress College is governed by the laws of the State of California and such supplementary regulations as have been prescribed by the Board of Trustees.

The following people are eligible to enroll in Cypress College:

- Any high school graduate OR
- Any person possessing a California high school proficiency certificate OR
- Any person eighteen years of age or older who may benefit from instruction OR
- Any K–12 student who qualifies for the Special Admit Program. (Refer to the Special Admit section of this Catalog)

Residency Determination for Tuition Purposes

All students who apply for admission to Cypress College are classified as California residents or non California residents for tuition purposes. Residents and nonresidents are charged according to the perspective fees set by the Board of Governors of the California Community College system.

“Resident students” are those who have resided within California for at least one year prior to the residence determination date and have met the residency standards stipulated in Title 5 of the California Administrative Code. The “residence determination date” is the day immediately preceding the opening day of instruction each semester or summer session during which the student proposes to attend college in the North Orange County Community College District.

Generally, residency requires actual physical presence in California coupled with the intent to become a resident. One’s state of mind is subjective; hence, it is necessary to look at objective indications of the student’s intent. Examples of evidence that aid the college admissions officer in identifying that intent, but are not individually decisive, are:

- California driver’s license or ID card
- Proof of registration to vote in California
- Licensing from California for professional practice
- Establishing and maintaining active California bank accounts
- California employment verification from your employer or pay stubs for the previous year
- Ownership of residential property or occupancy of rented or leased property in California
- State or federal income tax information document showing a California address
- Exceptions apply under certain conditions to active members of the Armed Forces

“Nonresident students” are those who have not established California residency status in the state for at least one year prior to the residence determination date or those who hold certain nonimmigrant visas that preclude them from establishing residency. Foreign students admitted to the United States under student visas are classified as nonresidents.

The California Education Code and provisions in state law allow certain nonresidents the opportunity to pay in-state tuition. Students who believe they are eligible for an exemption based on any one of the following criteria should consult the Admissions and Records Office when they apply for admission to the college.

Note: In order to determine residency status, students must bring all immigration documents, including visas, passports, and I-688 information to the Admissions and Records Office at the time of applying to the college. No single item may establish a case for California residency. It is up to the applicant to provide as many documents as possible to prove validity of a change to California residency.

AB540/AB2000 allows students, including undocumented immigrant students who meet the requirements of the Education Code, to be exempt from nonresident tuition in California’s universities and colleges.

In order to qualify for this exemption a student must have attended and/or graduated from a California public or private high school after three or more years. The attainment of a GED or certificate of high school proficiency would also exempt the student from paying nonresident tuition. Students living outside the State of California and enrolled in distance education courses are not eligible for the AB540 exemption.

All students seeking this exemption must file an affidavit and high school transcripts with the college. The affidavit is included in the California Nonresident Tuition Exemption form which is available at the Admissions and Records Office.

Specific information regarding residency can be obtained from the Admissions and Records Office. Additional details can be obtained from the college website, the California Education Code and Title 5 of the California Code of Regulations.

Open Enrollment Policy

In conformity with the provisions of Title 5 of the California Administrative Code, it is the policy of the Board of Trustees of the North Orange County Community College District that, unless specifically exempted by statute, every course, course section or class, wherever offered and conducted throughout the District, shall be fully open to enrollment and participation by any person who is eligible for admission to the college and meets the stated prerequisites.

Students who are enrolling in the North Orange County Community College District for the first time and those who are returning after an absence of a Fall or Spring semester must submit the online admission application, known as Open CCCApply. Students who withdraw from the college during the first three weeks of a term must also submit a new admission application. The online application can be accessed on the college website, www.CypressCollege.edu.

Applications for admission will be accepted beginning March 1 for Summer and the Fall semester and beginning October 1 for the Spring semester.

New Enrollment Priorities Effective Fall 2014

As part of the Student Success Act 2012, Cypress College priority registration is changing. To guarantee eligibility for Priority Enrollment for Fall 2017, all **New and Returning Students** must meet the following three requirements:

- Complete the **assessment process** — math and English placement tests (or equivalent),
- Attend an **orientation** session, and
- Complete a **one semester education plan**.

Returning and Continuing Students must meet the following three requirements:

- Be in good academic and/or progress standing — not have been placed on academic dismissal and not on probationary status for two consecutive terms,
- Have completed 75% or more units with A, B, C, CR, and P, and
- Have not earned more than 100 degree-applicable units (at Cypress and Fullerton), excluding basic skills courses.

Registration

Registration appointments are established for each student according to enrollment priorities and the date and time the student submitted the online admission application. Although students can register after their assigned date and time, registering on their specific date provides a better selection of classes; however, enrollment is not guaranteed into any class.

A registration email is sent to all new, returning and continuing students. The email indicates the earliest date and time the student can register for classes. Students can also view their registration date and time under Personal Announcements of myGateway's student tab.

Certain registration and admission deadlines must be established. These deadlines are necessary in order to comply with state attendance laws and must be followed by faculty and students. Failure to comply with these deadlines may mean that the student will not be allowed to attend or receive credit for classes.

New Students

To be eligible for priority enrollment all students must meet the following requirements: complete the **assessment process** — math and English placement tests (or equivalent), attend an **orientation** session (in-person or online), and complete a **one semester education plan**. Any student who does not complete all three steps will receive a registration date and time, but it will not be a priority registration date.

Returning Students

To be eligible for priority enrollment all students must meet the following requirements: complete the **assessment process** — math and English placement tests (or equivalent), attend an **orientation** session (in-person or online), and complete a **one semester education plan**. In addition, returning student must be in good academic and/or progress standing — not have been placed on academic dismissal and not on probationary status for two consecutive terms, have completed 75% or more units with A, B, C, CR, and P, and have not earned more than 100 degree-applicable units (at Cypress and Fullerton), excluding basic skills courses. Any student who does not meet all of the above requirements will receive a registration date and time, but it will not be a priority registration date.

Continuing Students

Continuing students are given priority registration based on completion of units and the following required criteria: must be in good academic and/or progress standing — not have been placed on academic dismissal and not on probationary status for two consecutive terms, have completed 75% or more units with A, B, C, CR, and P, and have not earned more than 100 degree-applicable units (at Cypress and Fullerton), excluding basic skills courses. Any student who does not meet all of the above requirements will receive a registration date and time, but it will not be a priority registration date.

Assessment

In order to be placed in appropriate class levels students are evaluated and assessed in the areas of English, ESL, reading, writing, and mathematics. Students with recent placement results from other colleges may be accepted. Students with placement results completed within the last two years may be accepted. Students must submit official copies of placement test results with the Alternative Assessment Petition to the CC Assessment Center (Student Center, 2nd floor) for verification and assessment waiver. The Alternative Assessment Petition is available online at <http://www.CypressCollege.edu/admissions/gettingStarted/assessment>. Placement test information from other colleges must include the student's name, name of the test(s), the raw score(s), and course placement.

Students who have attended another college and have completed the necessary course work in English and Math can submit unofficial transcripts with the Alternative Assessment Petition to the CC Assessment Center (Student Center, 2nd floor) for verification and assessment waiver. The Alternative Assessment Petition is available online at <http://www.CypressCollege.edu/admissions/gettingStarted/assessment>.

Counseling/Orientation

Students are strongly advised to meet with a counselor prior to registration. Counselors are well informed in various fields of study and can assist students in long-range planning for specific educational plans. New and returning students are required to attend an orientation to receive important information on offered programs, policies, and registration procedures. Orientation appointments are made at the conclusion of the assessment testing. Students can attend an in-person orientation or elect to complete an orientation online.

myGateway

myGateway is the web portal that enables students to view their registration times, class schedules, grades, academic history, added or dropped classes, and access to a variety of useful resources. A student ID number and Personal Identification Number (PIN) is needed to log into myGateway which can be accessed on the college website.

Fees

ASSOCIATED STUDENTS BENEFITS PROGRAM

– More than just a sticker, an opportunity!

The Cypress College A.S., in addition to acting as a voice for the student body, has put forth an exciting and valuable benefits program. For a modest fee of \$7.00 per semester, a sticker may be bought that entitles the holder to privileges and services both on campus and throughout the community. Beneficiaries enjoy discounts at local food and retail businesses as well as exclusive access to the Student Activities computer lab and game center. Additionally, portions of the proceeds obtained from the purchase of these stickers are used to enrich the college's academic, athletic and artistic community by helping to fund extracurricular programs and events. The sticker may be purchased online via WebStar during registration or at the Admissions and Records office throughout the semester. For further information on the Associated Benefits Sticker, visit the Student Activities Center, or call (714) 484-7198.

CAMPUS ID CARD

– Enrich your college experience!

The Campus ID card is an invaluable tool which not only identifies Cypress College students, but also grants them access to a wide array of services and programs. A smart addition to any wallet, the card is required at the library, bookstore and gym as well as the various computer/learning labs located throughout the college. In addition, a student may be required to present their ID when using support services such as Financial Aid, Admissions and Records, Bursar's, and the Transfer Center. The card may be purchased online via WebStar during registration or at the Admissions and Records office throughout the semester. Please note: the \$2.50 fee must be paid every semester. This fee entitles the student to a new ID card. For further information on the Campus ID Card, visit the Student Center on the 1st floor.

ENROLLMENT FEES

All students, residents and non-residents must pay the enrollment fee of \$46.00 per unit (\$23.00 per .5 unit). The enrollment fee may vary should the state legislature take action to change it.

HEALTH FEE

Pursuant to health code and district policy, Cypress College has a mandatory health fee. The health fee is \$19.00 per semester (\$16.00 for the Summer Intersession) for each student regardless of the number of units taken.

Any student who depends exclusively on prayer for healing in accordance with the teachings of a bona-fide religious sect, denomination or organization, provided that the student presents documentary evidence of an affiliation of such bona-fide religious sect, denomination or organization, shall be exempt from paying such a fee. Additionally, students attending Cypress College exclusively under an approved apprenticeship training program are exempt from paying the health fee. The health fee will be refunded to any student who withdraws from all courses prior to the 10% date of the length of the course. All Special Admit students are required to pay the health fee each term they attend.

NON-RESIDENT TUITION

Non-residents of the State of California are charged tuition at \$249 per unit (includes \$15.00 per unit capital outlay fee as provided in Education Code Section 76141). Non-resident tuition is in addition to the enrollment fee paid by all students. If you believe you should be reclassified as a resident student, it is your responsibility to request reclassification at the Admissions and Records Office prior to registering.

PARKING

Use of Cypress College's general parking lots requires a parking fee. In lieu of a physical parking permit, the College uses a virtual parking system. Students and guests purchase virtual permits online. After purchasing a parking permit, students and guests must register their vehicle license plate number to activate the virtual parking permit. Those who purchase semester-length permits may change vehicle license plate numbers online at any time using the website. Day-use vehicle registration is available at kiosks on campus. Physical parking passes are not issued to students or guests. Payment for semester permits and registration of plates authorizes students to use any of the seven lots open to student and guest parking, as well as designated spots on Circle Drive. Cypress College semester-length parking permits are also honored at Fullerton College and the Anaheim Campus.

REFUNDS

Enrollment fees, non-resident tuition fees, health fees and material fees are fully refundable if withdrawal from classes is processed on or before the end of the second week of classes. (See current semester schedule for exact dates.) Refunds must be requested during the semester of attendance. After the second week, there will be no refunds for withdrawal. The same fees for Short Term classes are refundable if the student withdraws from class by the 10% date of the length of the course.

REFUND PROCESSING FEE

A refund processing fee of \$10.00 per semester will be deducted from the enrollment fee refunds. The fee will be waived for students who are administratively dropped from class(es) due to cancellation of class(es), student disqualification or course repetition.

SERVICE CHARGE

There is a \$25.00 service charge on all checks returned by your bank, and your enrollment at the College, as well as your credit, may be affected.

Cypress College participates in the COTOP program (Chancellor's Office Tax Offset Program) and will be charging the administrative fee if your account is sent to COTOP for collection. To avoid these additional charges, please pay all debts owed to the college in a timely manner. This includes registration fees, checks returned by your bank, and any other fees due on your student account.

SERVICE FEES

Cypress College requires payment for certain services rendered by the Admissions and Records Office:

Legal Research and Subpoena Processing — \$15.00

Duplicate diplomas and certificates — \$15.00

On demand service — \$10.00

STUDENT REPRESENTATION FEE

All students are urged to pay this \$1.00 fee. This fee will be used so that students may represent students' views and positions at city, county, and district governments as well as state legislative offices and other governmental agencies.

TRANSCRIPT FEES

The first two copies of the student transcript are free and a \$3.00 fee per transcript is levied thereafter. These fees apply to electronic and in person transcript requests. (NOTE: The \$3.00 fee is subject to change at any time.) Obtain further transcript information from the Admissions and Records Office.

VERIFICATION OF ENROLLMENT

Beginning Fall 2006, Cypress College authorized the National Student Clearinghouse (NSC) to provide degree and enrollment verifications on behalf of past and present Cypress College students. This self-service is free and adheres to the privacy mandates of the Family Education Rights and Privacy Act (FERPA) of 1974.

NSC is conveniently accessible 24 hours a day, 7 days a week on the student tab after logging into myGateway. Enrollment verifications are generally available ten business days after the beginning of a term. All other verifications will be charged \$3.00 per request.

Third party verifications can be obtained through www.studentclearinghouse.org for a fee of \$3.00. In rare cases when a verification form must be completed by the Admissions and Records Office, a fee of \$3.00 per request will be charged. Rush requests are an additional \$10.00 and photo ID is required for service.

For the processing of loan forms students are advised to contact the Financial Aid Office.

Academic Policies

Academic Freedom

(This represents Board Policy AP4030, adopted 2/12/08)

The Association of American Colleges and the American Association of University Professors have long recognized that membership in the academic profession carries with it special responsibilities. The protections provided under this section are correlative with certain duties. Academic freedom must be balanced with the obligation of the District to protect the right of students to learn in an environment characterized by civility, open inquiry, and rigorous attention to the search for the truth, free of unlawful discrimination.

It is recognized that an essential function of education is a probing of opinions and an exploration of ideas that may cause some students discomfort. The District affirms the use of a variety of teaching methodologies to fulfill its obligation to raise difficult and meaningful questions in the educational development of students in curricular and co-curricular settings. Faculty members are entitled to freely discuss issues germane to their subject matter as measured by professional standards set by the community of scholars. This freedom involves the right to introduce controversial topics, as long as the manner of presentation involves objective reasoning and rational discussion.

There shall be no curtailment of faculty presentation of factual or theoretical material relating to all points of view.

Faculty are citizens, members of a learned profession, and officers of an educational institution. When they speak or write as citizens, they should be free from institutional censorship or discipline. However, when doing so, they should apply the best standards of their professions and make every effort to indicate they are not speaking for the institution.

The District will consult with discipline faculty chosen by the Academic/Faculty Senate with respect to contemporary practices and professional standards for course content and delivery when evaluating issues of academic freedom.

Academic Honesty

Students are expected to abide by ethical standards in preparing and presenting material which demonstrates their level of knowledge and which is used to determine grades. Such standards are founded on basic concepts of integrity and honesty. These include, but are not limited to the following areas:

- 1) **Students shall not plagiarize, which is defined as stealing or passing off as one's own ideas or words of another and as using a creative production without crediting the source. The following cases are examples of what constitutes plagiarism:**
 - paraphrasing published material without acknowledging the source.
 - making significant use of an idea or a particular arrangement of ideas, e.g., outlines.
 - writing a paper after consulting with persons who provide suitable ideas and incorporating these ideas into the paper without acknowledging the debt.
 - submitting under one's own name, term papers or other reports which have been prepared by others.
- 2) Students shall not cheat, which is defined as using notes, aids, or the help of other students on tests or exams in ways other than those expressly permitted by the instructor; and as misreporting or altering the data in laboratory or research projects involving the collection of data.
- 3) Students shall not submit an original paper or project to more than one class without approval from the second instructor. Instructors who do not accept previously submitted papers should so inform the students in the course syllabus.
- 4) Students shall not furnish materials or information in order to enable another student to plagiarize or cheat.

Plagiarism Prevention and Detection: In its commitment to academic honesty, Cypress College uses Turnitin.com software to prevent and detect plagiarism.

The instructor reserves the right to submit student assignments to Turnitin.com to check for textural similarities between those assignments, Internet sources and the Turnitin.com assignment database. Students will be required to electronically submit their written work for plagiarism checking. Assignments submitted to Turnitin.com will become part of their database and will be used only for plagiarism prevention and detection.

Students agree that by enrolling in a course, assignments may be subject to the above plagiarism prevention and detection processes.

An instructor who has evidence that an act of academic dishonesty has occurred, after speaking with the student, is obligated to take the following steps:

- 1) Assign an appropriate academic penalty such as an oral reprimand (as in cases where there is reasonable doubt that the student knew that the action violated the standards of honesty); or assign an "F" on all or part of a particular paper, project, or exam (for example, where there was proof that it was a one-time occurrence). In cases where an "F" was assigned, report the incident to all appropriate personnel. (See Step 3.)

- 2) In cases where the dishonesty was serious, premeditated, or part of an ongoing scheme, request an ad hoc review board made up of at least three faculty from the department or division of the instructor involved. This review board is to be appointed by the Academic Senate President or his/her delegate in consultation with the department coordinator, or if none is in place, with the members of the department. Supply to the review board the documents which are suspect and any other documents completed by the student which might help determine if academic dishonesty occurred. It would then be the responsibility of the review board to determine academic penalties as appropriate.
- 3) Report to the student involved, to the department coordinator, to the Division Dean, and to the Dean of Counseling and Student Development, the alleged incident of academic dishonesty, including relevant documentation, and recommendations for action that he or she deems appropriate.
- 4) The appropriate Division Dean shall maintain an academic dishonesty file of all cases of academic dishonesty with the appropriate documentation.
- 5) Students shall be informed when their names are inserted into the file and provided with copies of any appeals or disciplinary procedures in which they may become involved. The appropriate Division Dean may initiate disciplinary proceedings under Education Code, Article 3, Section 76030–76037; when two or more incidents involving the same student occur, he/she shall do so.
- 6) Students charged with violations resulting in disciplinary action have the right to appeal the findings to the Petitions Committee under the Rules and Procedures of Due Process.

Academic Honors

HONORS AT ENTRANCE

High school graduates entering Cypress College as first time college students may qualify for Honors at Entrance by having earned a 3.5 GPA in high school with physical education grades excluded. The official high school transcript must be on file in the Admissions and Records Office. This achievement will be indicated on the college transcript. Application for Honors at Entrance should be made in the Admissions and Records Office during the student's first semester of attendance.

Semester Honors

DEAN'S LIST

Those students who officially **complete** (as shown on their transcript) twelve or more units in letter grade courses in a semester and earn a grade point average between 3.0 and 3.74 are placed on the Dean's List for the semester.

PRESIDENT'S LIST

Those students who officially **complete** (as shown on their transcript) twelve or more units in letter grade courses in a semester and earn a grade point average of 3.75 or above are placed on the President's List for the semester.

HONORS AT GRADUATION

In recognition of academic excellence for completion of the associate degree, students are awarded graduation honors as follows:

| | |
|-------------|-----------|
| Honors | 3.30–3.74 |
| High Honors | 3.75–4.00 |

Graduation honors are calculated using all degree applicable work completed. This includes course work completed at Fullerton College and all other accredited institutions for which an official transcript has been received.

Graduation honors will be indicated in the commencement program and on the student's diploma and transcript. However, for candidates (those students with final grades pending), the commencement program will note "candidate" as their degrees and honors have not yet been confirmed. When final grades are posted, a recalculation of grades will be completed and, if the student qualifies, the graduation honor will be noted on the diploma and transcript.

Academic Renewal Policy

Under certain circumstances students may elect to have previously completed courses that resulted in substandard grades disregarded in the computation of their grade point average (GPA). To reduce the negative impact of past academic failure, Cypress College supports Academic Renewal defined in accordance with Section 55046, Title 5, California Code of Regulations. Courses used in awarding an associate degree, certificate or transfer certification will not be alleviated.

- Only units taken at Cypress College may be disregarded. No more than twenty-four units of substandard grades (D, F, NC, and NP) may be disregarded.
- A minimum of twelve months must have elapsed since the most recent course work to be disregarded was recorded.
- A minimum of twelve units must be completed at Cypress College or any other accredited college or university with a grade point average of 2.5 in all units since the last substandard grade to be disregarded.
- Courses that meet the present educational goals of the student and that are appropriate for repetition may be exempt for consideration for alleviation.
- The college may disregard particular previously recorded substandard work in the computation of a student's cumulative grade point average according to the Academic Renewal procedures.
- A student may be granted Academic Renewal only once and it is irreversible once posted to the transcript. The substandard grade(s) alleviated will be subtracted from the grade point average; however, they will remain legible on the transcript and annotated to indicate Academic Renewal.
- Academic Renewal by Cypress College does not guarantee that other institutions outside the District will approve such action. This determination will be made by the respective transfer institution.

Students must file an Academic Renewal petition with the Admissions and Records Office. The form is available on the college website and in the Admissions and Records Office. If other college course work will be used to qualify for Academic Renewal, current and official transcripts from all of the accredited colleges must accompany the petition or be on file in the Admissions and Records Office at the time the petition is submitted.

Advanced Placement Credit

Please refer to External Exam Credit Area of this catalog. For information on general education credit earned for various exams see a counselor for clarification and additional information.

Attendance

Regular attendance is expected of every student. Attendance at the first class meeting is especially important since a full period of instruction begins the first day of the class. Any student not attending the first class meeting may be dropped by the instructor. Waitlisted students should also attend the first class meeting in the event the student is offered an available seat.

In the case where a class is taught entirely online, instructors may drop students who have not been in contact with the instructor by the end of the first day of classes for that semester or short-term session.

ABSENCES

Absences are handled as follows:

- After a student accumulates in any class more than a week's absences (more than the number of times the class meets per week), consecutive or nonconsecutive, an instructor may drop the student according to the drop deadline dates.
- Absences in a Distance Education course are accounted for by monitoring academic attendance or attendance at an academically-related activity. A student will be considered to be "present" in a course if there is evidence of weekly participation in an academically-related activity including, but not limited to, physically attending in-person sessions of a hybrid course, submitting an academic assignment, taking an exam, substantively participating in a course online discussion, study group, or other synchronous or asynchronous activity, or by initiating contact with the instructor in matters related to the course. It is the responsibility of the instructor to define grounds for dismissal in the Distance Education course syllabus.
- A student will be considered "absent" if there is no evidence of participation in an academically-related activity for the course for more than one week or if the student accumulates a consecutive or non-consecutive lack of academically-related activities of more than a week that is more than the number of times the class meets per week. For example, in a three-unit online class that would typically meet on campus three hours a week, one week's worth of missed academically-related assignment(s) or activity(ies) could be grounds for dismissal. A student who has not submitted assignments or participated in an academically-related activity for one week may be dropped from the course.
- A student who must miss one or more classes because of a field trip or other authorized activity, such as athletics or music groups, will be issued an *Authorized Absence Excuse* (available in each division office) by the instructor under whose supervision the activity will occur. The student shall have this excuse signed by the instructors of the classes that will be missed **before the absence occurs**. It is recommended that these transactions be carried out at least two days before the activity. The signed excuse must be presented to the instructor in charge of the activity, who shall in turn file it with the Admissions and Records Office upon the conclusion of the activity.

- No absence excuses a student from making up class work missed. Students should realize that undue absences may adversely affect their grades.
- In the event a student is absent for a prolonged period of time it is expected that contact will be made with the respective instructors immediately to advise the instructor of this absence and the reasons for it. The instructor may then decide whether or not the student may continue in the class or withdraw. It should be noted that failure to make this contact and follow through with the decisions made at this time could result in the student receiving a grade of “F” or “NP” in the class.

STUDENT RESPONSIBILITY

While an instructor may drop a student who has poor attendance, it is the student’s responsibility to officially drop the class through myGateway. Failure to officially withdraw within the published deadlines may result in the assignment of a substandard grade. Refer to the Class Schedule for further instructions on “How to Add/Drop a Class.”

Auditing

Auditing is available for currently enrolled students who have successfully completed a class for credit the maximum times allowed at Cypress College. Enrolled students who wish to audit a class must file an audit petition which is available at the Admissions and Records Office.

The petition must be submitted during the second week of the class. Upon consultation with the instructor and the dean of the division involved, the Admissions and Records Office will review the petition for approval or denial. Once the request has been approved, students will not be permitted to change from an audit to a credit status. Auditing a class does not result in a grade posted to the student’s transcript. For required fees and additional information, contact the Admissions and Records Office.

Catalog Rights

Cypress College issues a new catalog each year. The information published in the catalog is in effect for the academic year beginning with the Fall semester and concluding with the Summer session.

The courses required for a specific degree or certificate, or general education may change from one catalog to the next and, therefore, may change during the period of time that a student attends the college. Catalog rights, established when a student first takes classes at the college, protect the student from being held for additional requirements that may be added to a later catalog.

For the purposes of meeting graduation or certificate requirements, students may elect to meet the requirement of either

- (1) The catalog that was in effect at the time they began taking courses at Cypress College, or
- (2) Any catalog that is or has been in effect during the time that they have maintained continuous enrollment before graduation, or
- (3) The catalog that is in effect at the time they file an application for a degree or certificate.

Students maintain catalog rights by maintaining **continuous enrollment** at Cypress College — that is, by receiving a grade of “A,” “B,” “C,” “D,” “F,” “CR,” “P,” “NC,” “NP,” “RD,” “W,” or “I” on their transcripts for at least one course per academic year. Documented military or medical leave or attendance at another regionally accredited institution of higher learning will not be considered an interruption of enrollment. This policy supersedes all previous catalog rights provisions and applies only to programs at Cypress College.

The academic year is considered Fall and Spring and does not include the Summer term for continuous enrollment purposes.

Challenging Prerequisites, Corequisites, or Other Limitations on Enrollment

GROUNDS FOR CHALLENGE

Where a student is denied enrollment in a program or course on the grounds that the student does not meet a prerequisite or corequisite, or on the basis of other limitations on enrollment, the student may challenge such prerequisite, corequisite or limitation on one or more of the following grounds:

1. The prerequisite, corequisite or other limitation on enrollment has not been established in accordance with the district’s process for establishing prerequisites, corequisites, and other limitations on enrollment.
2. The prerequisite, corequisite or other limitation on enrollment is either unlawfully discriminatory or is being applied in an unlawfully discriminatory manner.
3. The basis upon which the district has established an enrollment limitation does not in fact exist.
4. The student has the knowledge or ability to succeed in the course or program despite not meeting the prerequisite or corequisite.
5. The student will be subject to undue delay in attaining the goal of his or her educational plan because the prerequisite or corequisite course has not been made reasonably available by the college.

BURDEN OF PROOF

The student shall bear the burden of proof in demonstrating that grounds exist for the challenge.

1. In the case of a challenge under Grounds for Challenge number 4, the student shall provide evidence of knowledge and/or skills, by virtue of placement/assessment testing, academic course work, independent learning, experience, or a combination of these which are at least equivalent to the knowledge and/or skills the student would have possessed had he or she successfully completed the prerequisite or corequisite.
2. In the case of a challenge under Grounds for Challenge number 5, the student shall provide evidence that the student has declared a broad educational intent or specific educational goal and has developed a Student Educational Plan in conformity with the provisions of Section 55530(d) of Subchapter 6 of Chapter 6 of Division 6 of Title 5 of the California Code of Regulations.

CHALLENGE PROCEDURE

Filing of Challenge:

1. A challenge with respect to any prerequisite, corequisite or limitation on enrollment initiated pursuant to this policy shall be made upon the appropriate challenge form, which may be obtained from the Student Success and Support Program Office or the Office of Instruction.
2. The completed challenge form must be filed with the Office of Instruction in accordance with the following deadlines:
 - a. for the Fall term, not earlier than Friday of the fifteenth week of the Spring semester and not later than the first day of instruction for the Fall semester;
 - b. for the Spring term, not earlier than Friday of the twelfth week of the Fall semester and not later than the first day of instruction for the Spring semester;
 - c. for the Summer intersession, not earlier than the first Monday in May and not later than the first day of final examinations for the Spring semester.
3. In the case of a challenge under Grounds for Challenge number 4, the completed challenge form must be accompanied by appropriate evidence of skill or accomplishment such as placement/assessment results, transcripts from an accredited institution or appropriate foreign institution, work-related experience, or other evidence of relevant experience. To warrant consideration, any such evidence shall be of a clear and reliable nature.

Class Cancellations

Cypress College reserves the right to cancel any class for which enrollment is not sufficient to warrant continuation, and to change the class hours and/or days as necessity demands.

Class Transfers

A student may change from one section to another of an identical course with the same or different instructors providing the instructors approve. The change may take place at the same or different level in the same subject area at any time during and up through the twelfth week for semester length classes, and by the last day to drop with a “W” for classes that meet less than the full length of the semester, provided both instructors approve. The class must be of like duration and within the same date range. Consult the Admissions and Records Office for information on the required class transfer process and deadlines for classes that meet less than the full length of the semester.

CLEP Examination Credit

Please refer to External Exam Credit Area of this catalog. For information on general education credit earned for various exams see a counselor for clarification and additional information.

Computing Resources Acceptable Use Policy

PURPOSE: The purpose of this document is to explain the terms of use for instructional computing resources available to students of Cypress College. All computing resources are intended to support the research and educational mission of Cypress College; their use is a privilege and a responsibility. The use of computing resources is subject to all applicable local, state and federal laws, the general guidelines

outlined in this document, and any specific guidelines in effect at individual campus computing centers. The district “Acceptable Use/Computer and Electronic Communication Systems” policy can be found at http://www.nocccd.edu/files/bp3720_10160_24838.pdf and http://www.nocccd.edu/files/3720apfinalreviseddccc2015-11-23_24854.pdf.

DEFINITION: As used in this document, computing resources include (but are not limited to): personal computers, laptops, mobile devices (tablets), Local Area Network (LAN), Wide Area Network (WAN), wireless system, printers and related peripheral devices, software applications such as Microsoft Office Suite, Library Systems Catalogs/Databases, all Internet resources and services and all other computer related technology and resources made available on campus.

CAMPUS COMPUTING CENTERS: Individual computing centers maintain their own specific policies regarding the use of their resources. Users of individual computing centers are to follow these policies. Computing centers are authorized to enforce both the campus Acceptable Use Policy and their own individual policies. Users who establish individual computer accounts for use of Internet email or other applications will be required to sign an agreement to abide by the policies of the computing center issuing those accounts.

ENFORCEMENT: *The Acceptable Use Policy is intended to establish and declare the personal responsibility of every individual who uses any computing resource at Cypress College.* By making this policy public and available to all users of computing resources on the campus, Cypress College and its designated representatives reserve the right to deny any or all computing privileges from any individual who refuses to follow the guidelines for responsible computing use. Cypress College also reserves the right to limit, restrict, or deny access to any and all computing resources as the individual situation may require.

GENERAL GUIDELINES: The following guidelines are to be followed by every individual who makes use of computing resources at Cypress College:

The use of computing resources and any resources accessed by them is for the instructional purposes of Cypress College. Individual computing centers reserve the right to restrict activities such as personal email or games when instructional needs require the computing resources.

No tampering with the computing resources. This includes but is not limited to: connecting or disconnecting computer equipment, unauthorized loading of software on a computer, or otherwise altering the set-up of any computer or network of computers in any way.

No illegal use of computing resources. This includes but is not limited to: loading virus programs onto or from any computer system, using the Internet or other telecommunications-based resources to transfer illegal materials or unauthorized versions of copyrighted material, using the Internet to harass, terrorize, blackmail, defraud, or otherwise abuse another person, or using any computing resource in such a manner that it constitutes the breaking of a District or campus policy, or a local, state or federal law.

No use of computing resources for financial or political gain. This includes but is not limited to: sending “chain letters” or other unauthorized and illegal correspondence, advertising, marketing or selling of products, and campaigning for any political cause or individual.

No violation of other individuals’ privacy or rights. This includes but is not limited to: accessing another person’s account or any data stored and used by that person, sharing another person’s private correspondence with others, destroying or modifying data that belongs to someone else, or sending offensive messages of any kind.

Observe all regulations and rules of the individual computing centers. This includes but is not limited to: observing hours of operation, maintaining a reasonable level of quiet in order for others to work, and following all that center's policies regarding food and beverage use, time limits, printing and downloading, and any other terms of use.

Failure to follow these guidelines may result in disciplinary action on the part of Cypress College and any of its designated representatives (including individual computing centers). Such action may include: restriction or suspension of computing privileges at any or all individual campus computing centers, suspension of other campus privileges, including registration and enrollment, and notification of law enforcement officials.

Continuous Enrollment

See Catalog Rights.

Corrections to Student Information

Documentation to provide residency, correct a date of birth or social security number must be submitted to the Admissions and Records Office. Students must obtain a Personal Information Change form from the Admissions and Records Office to change their name on official college records. Proof of a legal name change, such as a marriage license, court order or naturalization papers, is required to complete the request. It is recommended that a new student ID card be obtained from Photo ID on the first floor of the Student Center. Mailing/email addresses and phone numbers can be updated on the Personal Information channel on the student tab of myGateway.

Course Double Counting

Students are permitted to double count courses to meet major and general education requirements for graduation. Students cannot double count units of credit. Further information can be obtained from the offices of Counseling and Admissions and Records.

Course Numbering

Courses completed at Cypress College will transfer to other community colleges. Courses numbered 001 C–099 C are remedial, occupational and/or technical and designed in content and organization for students who do not intend to transfer for the Bachelor's degree. Courses numbered from 100 C–299 C (including Honors courses) have been certified by Cypress College as being of baccalaureate level for the current school year and as such are transferable to any campus of the California State University system. The transfer institution, however, will determine the extent to which a course satisfies the requirements of a particular degree program. Credit not otherwise applied shall be acceptable as general electives to the extent that the particular degree objective permits. Students who plan to transfer to any campus of the University of California or other university or college should check with a counselor for transferable courses since some universities do not accept all courses numbered 100 C–299 C.

Course Progression

Students are expected to take courses on an acceptable progressive basis. Generally students will not receive credit for classes which are considered lower in degree of advancement than those already taken.

Course Repeat Adjustment

In the case of a legally repeated course in which a student initially received a "D" or "F" grade at Cypress College, the original grade will be excluded from the grade point average upon request by the student. Exclusion of a substandard grade is not automatic if the course is repeated and a better grade is received. If the student opts to repeat the course a second time and requests its exclusion, the last grade received will be the only grade included in the student's grade point average. A remaining substandard grade for the same course will not be excluded from the student's grade point average except by an approved Academic Renewal. The exception to Academic Renewal is if the student has used the remaining substandard grade for the completion of an associate degree, certificate, transfer certification or Academic Renewal has already been granted and posted on the student's permanent record.

Course Repeat Adjustment cards can be obtained in the Admissions and Records Office and must be submitted by the student. If the adjustment is approved, the student's Cypress College permanent record shall be annotated in such a manner that all course work remains legible; however, Cypress College does not annotate or otherwise alter the permanent records of any other institution.

Course Repeatability Limitations

Effective 2013, most *active participatory* courses in Art, Dance, Theater, Music, and Physical Education are no longer repeatable. Note: Exceptions for active participatory courses still designated as repeatable are indicated in course descriptions of the college catalog and class schedules with the statement, "May be taken for credit ___ times." In addition, active participatory courses that are related in content have been placed in distinct "families" and are limited to 4 course enrollments (withdrawals and substandard grades will be counted towards the 4 enrollment maximum). Courses that fall into the "family" limitation can be viewed under the academic department course section in this catalog for the departments listed above. If students are majoring in any of these disciplines, they are advised to see their counselor to discuss options.

Course Repetition

- Students may repeat no more than two times the same course in which substandard grades or W's were assigned at Cypress and Fullerton Colleges. Substandard grades are considered to be D, F, NC, or NP.
- The college shall exclude the first two substandard grades a student has earned in a course offered at a college within the District in computing the overall grade point average if the student repeats the course two times.
- Students may petition to have a substandard grade, grade points, and units excluded from the computation of the student's grade point average in accord with college procedures.
- An assignment of MW in accord with provisions related to military service shall not count toward the college computation or exclusion related to probation or dismissal.
- An assignment of MW shall not count toward the maximum allowable number of repetitions to which the student would otherwise be entitled.

- Students who have previously earned a grade of C or better in a course offered at the colleges within the District shall be allowed to repeat the course under certain conditions.
- In accord with a determination that such repetition is required as a disability-related accommodation for a particular student, repetition in a special class for students with disabilities shall be allowed.
- When course repetition occurs, the permanent academic record shall be annotated in such a manner that all work remains legible, insuring a true and complete academic history. (NOCCCD BP4225 — effective March 8, 2011)

Credit by Examination

The basic purpose of Credit by Examination is to allow unit credit, for prior or advanced knowledge of class material. Credit by Examination is also considered “challenging a course.” Students may request a challenge of subject matter in which they are especially qualified through previous training or experience. Examinations will be sufficiently comprehensive to determine if the student has essentially the same knowledge and skills as a student who successfully completes the course.

Credit by Examination is available under the regulations listed below:

1. Students must be currently enrolled at Cypress College in a course other than the course being challenged.
2. Students must contact the division office to obtain the courses that can be challenged.
3. Credit by Examination may be taken only for a course listed in the catalog of the community college the challenged course is offered.
4. Students should read the course description in the catalog to gain understanding of the class content.
5. Students can receive credit for a maximum of twelve semester units.
6. A previous enrollment or audit for a course, a grade (including a W) prevents a challenge.
7. Prior credit or advanced placement cannot have been previously received.
8. Credit by Examination is not intended to replace make-up examinations for college courses not completed or courses taken in high school.
9. Less advanced courses cannot be challenged if they are considered lower in degree than those already taken.
10. Students may challenge a course only once.
11. Students must pay appropriate enrollment and health fees prior to taking the examination. Fee waivers do not cover Credit by Examination fees.
12. Credit by Examination will not be posted to the transcript until all fees or holds have been resolved.
13. Credit by Examination is graded on a Pass/No Pass basis. If students choose to have passing results recorded on their permanent record, the Pass (P) grade and the unit value will appear with a notation indicating the credit was obtained by Credit by Examination.

Note: A Pass/No Pass option should be discussed with a counselor if a student is planning to transfer to a four-year institution. Many

transfer institutions do not accept Credit (CR) or Pass (P) grades for major, minor and general education requirements.

14. Some of the courses challenged may be taken for a letter grade and will be posted to the student’s permanent record with a notation that the credit was obtained by Credit by Examination; however, it will not count towards the twelve residency units required by Cypress College to earn an associate degree.

To initiate a petition for Credit by Examination, students must confer with the instructor and division dean no later than the eighth week of the semester. Criteria for petition approval will be determined by the division. General guidelines will include evidence of previous learning experience and evidence to indicate probable success in the examination.

If it is determined that a student’s prospects for examination success are satisfactory, the student must obtain the signatures of the instructor and dean on the Credit by Examination petition. The student must submit the completed petition to the division dean no later than the end of the eighth week of the semester. The time and place of the examination, its content and the arrangement for its administration are determined by the division. The appropriate fees must be paid prior to the examination. The examination must be given before the end of the semester and students must contact the division for the examination results.

The following courses may be challenged by examination:

| | |
|--|---|
| Aviation and Travel Careers See Department Program Director | MATH 150BC Calculus II |
| Dental Assistant Courses See Department Program Director | MATH 250AC Multivariable Calculus |
| Dental Hygiene Courses See Department Program Director | MATH 250BC Linear Algebra/Differential Equations |
| Health Info Tech Courses See Department Program Director | Mortuary Science Courses See Department Program Director |
| Health Science Courses See Division Dean | Nursing Courses See Department Program Director |
| MATH 130 C Survey of Calculus | KIN 284 C Contemporary Personal Health |
| MATH 150AC Calculus I | Psychiatric Tech Courses See Department Program Director |

Credit for Prior Learning or Non-Collegiate Instruction

Cypress College grants up to 30 units of undergraduate degree credit for successful completion of non-collegiate instruction, either military or civilian, for learning, knowledge or skills-based experience, or that has been recommended by the Commission on Educational Credit and Credentials of the American Council on Education. Requests for Credit for Prior Learning will be evaluated individually.

Students who have at least one year of active military service may be granted 4–12 units of undergraduate credit. Every effort should be made to assure that “military” credit is used to advance individuals toward degree completion. For further information regarding military credit, see a counselor in the Veteran’s Resource Center.

Examinations

Class instruction includes frequent examinations throughout the semester so that students can judge their progress. The final examination is a requirement for each course and will be given on the last day of the class. All students must take these examinations at the scheduled time and place. Any exceptions to the above policy will be made only after consultation with the Division Dean.

External Exam Credit

Advanced Placement (AP), College Level Exam Program (CLEP), International Baccalaureate (IB)

A passing score on an AP exam, CLEP exam, or IB exam may allow a student to receive subject credit for various requirements. The college utilizes external exam scores for placing students in appropriate course work in some cases as well as waiving students from specified occupational degree and/or certificate major course work or college graduation requirements. Please see a counselor for more information. Information regarding which subjects can receive local external exam (AP, CLEP, IB) credit can be obtained from A&R and Counseling Offices.

Attention Students: You should not take classes for which you have earned external exam credit unless a specific university requires a higher score and/or your university major requires it. Duplicative credit will not be awarded by the college or transfer university. Talk to your counselor if you are uncertain whether or not your university major requires a course that you have already received AP, CLEP, or IB credit to determine if you have earned the appropriate score, or need to take the course. Students must file a petition in the Office of Admissions and Records (A&R) to have external exam credit reflected on the college transcript. **It is strongly recommended that students discuss the applicability of external exam credit with a Cypress College counselor before submitting the Petition form to A&R.** The petition form may be obtained from the A&R Office or via link to downloadable forms on the college website: <http://www.CypressCollege.edu/admissions/admissionsAndRecords/downloadableForms.aspx>. In order for the external exam credit to be applied via petition, the official AP, CLEP, or IB scores must be on file in the A&R Office or submitted at the time of petition. Students must have the College Board send exam results to A&R (or hand carried copies are also accepted as long as they are in a sealed envelope).

External exam credit (AP, CLEP, IB) awarded for transfer admission and major requirements is determined by the receiving institution.

The UC policy for external exam credit as it applies toward a student’s major is located in the *Quick Reference for Counselors* guide, available for reference in Counseling Offices and the Transfer Center and is also online at <http://admission.universityofcalifornia.edu/counselors/exam-credit/>.

Individual CSU campuses’ admissions websites list the external exam credit for major-specific requirements. Click on the link for each campus at www.calstate.edu/search_find/campus.shtml?source=homepage.

Students may earn credit for AP, CLEP, or IB exams to satisfy **IGETC (for CSU or UC transfer), CSU GE, and native A.A. general education (GE)**. Information on scores that are accepted for the different exams toward specific categories of these general education patterns and the number of units awarded for each category is listed in the following policy section. **NOTE:** Course credit and units granted by Cypress College for general education may differ from course credit and units granted by a transfer institution toward a student’s admission or transfer major program requirements. Please visit each transfer institution’s catalog for their external exam policy for admission or major.

AP (Advanced Placement) Scores Applied to General Education

A student earning a score of 3 or higher on an AP exam meets the following general education (GE) areas. The Cypress College transcript will show the AP exam credit applicable to the Native AA/AS GE as detailed below. Admissions and Records evaluators will adjust AP exam credit as applicable when a student applies for CSU GE Breadth or IGETC certification.

AP policy information for IGETC is also available at: <http://admission.universityofcalifornia.edu/counselors/files/ap-satisfy-admission-and-igetc-req.pdf>.

AP policy information for CSU GE Breadth is available at <http://www.calstate.edu/AcadAff/codedMemos/AA-2015-19.pdf>.

Note: * Students should not repeat classes for which they have earned AP credit unless a specific university requires it for their major. AP transfer credit awarded for admission and transfer major requirements is determined by the receiving university.

| AP Exam | IGETC ¹ Approved Credit (Includes American Institutions) | CSU GE Breadth Approved Credit (Includes American Institutions) | CCC GE Approved Credit |
|---|--|--|------------------------|
| Art History | 3A or 3B ² | C1 or C2 | C1 or C2 |
| Art (Studio)-Drawing, 2D,3D | n/a | n/a | n/a |
| Biology | 5B and 5C | B2 + B3 | B1 |
| Calculus AB | 2A | B4 ⁴ | B2 |
| Calculus BC | 2A | B4 ⁴ | B2 |
| Calculus BC/AB Subscore | 2A | B4 ⁴ | B2 |
| Chemistry | 5A and 5C | B1 + B3 | B1 |
| Chinese Language and Culture | 3B and 6A | C2 | C2 |
| Computer Science A | n/a | n/a ⁴ | n/a |
| Computer Science AB+ Computer Science Principles | n/a | n/a ⁴ | n/a |
| Economics (Macro) | 4B | D2 | D |
| Economics (Micro) | 4B | D2 | D |
| English Language and Composition | 1A | A2 | A1 |
| English Literature and Composition | 1A or 3B ² | A2 + C2 | A1 or C2 |
| Environmental Science | 5A and 5C | B2 + B3 (prior to F'09 only) or B1 + B3 | B1 |
| European History | 3B or 4F ² | C2 or D6 | C2 or D |
| French Language | 3B and 6A | C2 (prior to F'11 only) | C2 |
| French Literature | 3B and 6A | C2 (prior to F'09 only) | C2 |
| French Language and Culture | 3B and 6A | C2 | C2 |
| German Language | n/a | C2 (prior to F'11 only) | C2 |
| German Language and Culture | n/a | C2 | C2 |
| Comparative Government and Politics | 4H | D8 | D |
| U.S. Government and Politics | 4H | D8 and US-2 | D |
| Human Geography | 4E | D5 | D |
| Italian Language and Culture | n/a | C2 | C2 |
| Japanese Language and Culture | 3B and 6A | C2 | C2 |
| Latin | n/a | C2 | C2 |
| Latin Literature | n/a | C2 (prior to F'09 only) | C2 |
| Latin: Vergil | 3B and 6A | C2 (prior to F'12 only) | C2 |
| Music Theory | n/a | C1 (prior to F'09 only) | C2 |
| Physics B | 5A and 5C | B1 + B3 ⁵ (prior to F'13 only) | B1 |
| Physics 1 or 2 | n/a | B1 + B3 ⁵ | B1 |
| Physics C Mechanics | 5A and 5C | B1 + B3 ⁵ | B1 |
| Physics C Electricity/Magnetism | 5A and 5C | B1 + B3 ⁵ | B1 |
| Psychology | 4I | D9 (S'14) | D |
| Spanish Language | 3B and 6A | C2 (prior to F'09 only) | C2 |
| Spanish Literature | 3B and 6A | C2 (prior to S'13 only) | C2 |
| Spanish Language and Culture | 3B and 6A | C2 | C2 |
| Spanish Literature and Culture | n/a | C2 | C2 |
| Statistics | 2A | B4 | B2 |
| Studio Art | n/a | n/a | n/a |
| U.S. History | 3B or 4F ² | (C2 or D6) and US-1 | C2 or D |
| World History | 3B or 4F ² | C2 or D6 | C2 or D |

¹ There is no equivalent AP exam for the Area 1B, Critical Thinking/Composition, requirement.

² AP exams may be used in either area regardless of where the certifying CCC's discipline is located.

³ AP exams in Biology, Chemistry, or Physics B earn 4 semester or 5 quarter units toward IGETC certification. For Environmental Science, Physics C: Mechanics and Physics C: Electricity/Magnetism, 3 semester or 4 quarter units are applied for IGETC certification.

⁴ If a student passes more than one AP exam in calculus or computer science, only one examination may be applied toward the baccalaureate degree.

⁵ If a student passes more than one AP exam in Physics, only 6 units of credit may be applied to the baccalaureate, and only 4 units of credit may be applied to a certification in GE Breadth.

College Level Examination Program (CLEP) Scores Applied to General Education

A student earning a score of 50 or above on a CLEP exam meets the following general education (GE) areas. The Cypress College transcript will show the CLEP exam credit applicable to the Native AA/AS GE as detailed below. Admissions and Records evaluators will adjust CLEP exam credit as applicable when a student applies for CSU GE Breadth or IGETC certification.

This CLEP policy information for CSU GE Breadth is available at: <http://www.calstate.edu/AcadAff/codedMemos/AA-2015-19.pdf>. **CLEP scores may not currently be used for IGETC.**

Note: *Students should not repeat classes for which they have earned CLEP credit unless a specific university requires it for their major. CLEP transfer credit awarded for admission and transfer major requirements is determined by the CSU.

| CLEP Exam | CSU GE Approved Credit (Includes American Institutions) | CCC GE Approved Credit |
|---------------------------------------|--|------------------------|
| American Government | D8 | D |
| American Literature | C2 | C2 |
| Analyzing and Interpreting Literature | C2 | C2 |
| Biology | B2 | B1 |
| Calculus | B4 | B2 |
| Chemistry | B1 | B1 |
| College Algebra | B4 | B2 |
| College Algebra — Trigonometry | B4 | B2 |
| College Composition | n/a | A1 |
| English Literature | C2 (prior to F'11) | C2 |
| French Level II | C2 (prior to F'15 only) | C2 |
| Freshmen College Composition | n/a | A1 |
| German Level II | C2 | C2 |
| History, United States I | D6 and US-1 | D |
| History, United States II | D6 and US-1 | D |
| Human Growth and Development | E | D |
| Humanities | C2 | n/a |
| Introductory Psychology | D9 | D |
| Introductory Sociology | D0 | D |
| Natural Sciences | B1 or B2 | B1 |
| Pre-Calculus | B4 | B2 |
| Principles of Macroeconomics | D2 | D |
| Principles of Microeconomics | D2 | D |
| Spanish Level II | C2 | C2 |
| Trigonometry | B4 (prior to F'06 only) | B2 |
| Western Civilization I | C2 or D6 | C2 or D |
| Western Civilization II | D6 | C2 or D |

Note: CLEP Exams that do not receive credits for the CSU GE or Cypress College Native GE patterns are excluded from the table above.

International Baccalaureate (IB) Scores Applied to General Education

A student earning a score of 5 or higher on an IB exam meets the following general education (GE) areas. The Cypress College transcript will show the IB exam credit applicable to the Native AA/AS GE as detailed below. Admissions and Records evaluators will adjust IB exam credit as applicable when a student applies for CSU GE Breadth or IGETC certification.

This IB policy information for IGETC is also available at: <http://admission.universityofcalifornia.edu/counselors/files/ap-satisfy-admission-and-igetc-req.pdf>.

This IB policy information for CSU GE Breadth is also available at: <http://www.calstate.edu/AcadAff/codedMemos/AA-2015-02.pdf>.

Note: * Students should not repeat classes for which they have earned IB credit unless a specific university requires it for their major. IB transfer credit awarded for admission and transfer major requirements is determined by the CSU and UC.

| IB Exam | IGETC' Approved Credit (Includes American Institutions) | CSU GE Breadth Approved Credit (Includes American Institutions) | CCC GE Approved Credit |
|---------------------------------------|--|--|------------------------|
| Biology HL | 5B (without lab) | B2 | B1 |
| Chemistry HL | 5A (without lab) | B1 | B1 |
| Economics HL | 4B | D2 | D |
| Geography HL | 4E | D5 | D |
| History (any region) HL | 3B or 4F | C2 or D6 | D |
| Language A Literature HL | 3B and 6A | C2* | C2 |
| Language A Language and Literature HL | 3B and 6A | C2* | C2 |
| Language A1 (any language) HL | 3B | C2* (prior to F'13 only) | C2 |
| Language A2 (any language) HL | 3B | C2* (prior to F'13 only) | C2 |
| Language B (any language) HL | 6A | n/a | C2 |
| Mathematics HL | 2A | B4* | B2 |
| Physics HL | 5A (without lab) | B1 | B1 |
| Psychology HL | 4I | D9 | D |
| Theatre HL | 3A | C1* | C1 |

* A score of 4 earns credit for these CSU GE areas. All other scores must be a 5.

The IB Curriculum offers language at various levels for the native and non-native speakers. Language B courses are offered at the intermediate level for non-natives. Language A1 and A2 are advanced courses in literature for native and non-native speakers, respectively.

Grade Change

Any change in a grade given by an instructor shall be subject to California Education Code Section 76224 (a): *When grades are given for any course of instruction taught in a community college district, the grade given to each student shall be the grade determined by the instructor of the course and the determination of the student's grade by the instructor, in the absence of mistake, fraud, bad faith, or incompetency, shall be final.*

Students requesting an appeal related to a grade received from an instructor should follow procedures detailed under *Petitions and Appeals* in this Catalog. *Students have a two-year limit to request a grade change. To ensure that a request for a grade change is timely, students are encouraged to initiate their request for a grade change as soon as possible, and when possible, no later than the next regular semester following the award of the original grade. This policy supersedes all previous grade change provisions at Cypress College.* Students should be aware that no grade change will be made after two years from the date of the assignment of the grade. When a grade given in error has been corrected, the incorrect grade is expunged from the student's permanent record.

Grade Reports

Students can access grades using myGateway. Grades are generally available on myGateway approximately three weeks after the end of the term. It is recommended that a student ensure that all grades for the most recent term have posted to their permanent record before ordering a transcript.

Grading System

GRADES AND GRADE POINT AVERAGE

Grades are based upon the quality of work completed. The grade point average (GPA) is computed by dividing all GPA hours/units into quality points received. The meaning of each symbol and its value in quality points is as follows:

A— Superior or Excellent (4 grade points): Honor grade indicating excellence earned as a result of consistently superior examination scores, consistently accurate and prompt completion of assignments, ability to deal resourcefully with abstract ideas, superior mastery of pertinent skills, and promise of success in field relating to the subject.

B — Better than Average — Good (3 grade points): Honor grade indicating competence earned as a result of high examination scores, accurate and prompt completion of assignments, ability to deal well with abstract ideas, commendable mastery of pertinent skills, and promise of continued success in sequential courses.

C — Average — Satisfactory (2 grade points): Standard college grade indicating successful performance earned as a result of satisfactory examination scores, generally accurate and prompt completion of assignments, ability to deal with abstract ideas, average mastery of pertinent skills, and sufficient evidence of ability to warrant entering sequential courses.

D — Passing, Less than Satisfactory — (1 grade point): Substandard grade indicating the meeting of minimum requirements only earned as a result of low examination scores, generally inaccurate, incomplete or late assignments, inadequate grasp of abstract ideas, barely acceptable mastery of pertinent skills, or insufficient evidence of ability to make enrollment in sequential courses advisable.

F — Failing — (no grade points): Non-passing grade indicating failure to meet minimum requirements earned as a result of non-passing examination scores, inaccurate, incomplete or late assignments, failure to cope with abstract ideas, inadequate mastery of pertinent skills or repeated absence from class.

I — Incomplete — (no grade points, no units attempted, non-evaluative): Incomplete academic work for unforeseeable, emergency and justifiable reasons at the end of the term may result in an “I” symbol being entered in the student’s record. The condition for removal of the “I” shall be stated by the instructor in a written record. This record shall contain the conditions for removal of the “I” and the grade assigned in lieu of its removal. This record must be given to the student with a copy on file with the Registrar until the “I” is made up or the time limit has passed. A final grade shall be assigned when the work stipulated has been completed and evaluated, or when the time limit for completing the work has passed. The “I” may be made up no later than one year following the end of the term in which it was assigned. Under unusual circumstances a student may petition for a time extension. An incomplete grade must be changed to a letter grade before it can be repeated.

IP — In progress — (no grade points, no units attempted, non-evaluative): If a student making satisfactory progress in an open entry course has not finished a course at the end of a semester, the student shall be given an “IP,” which indicates the student is in progress of completing the course. The student must re-enroll in the course if the student wishes to continue working in that course. Failure to do so will result in an assignment of a grade by the instructor in place of the “IP.” “IP” shall not be used in calculating grade point averages.

P — Pass — (no grade points, no units attempted, but counts for units completed): Pass means that credit has been earned for the course although there are no grade points and the grade is not used in computing the grade point average, and will reflect performance equivalent to a C or better under the letter grade system.

NP — No Pass — (no grade points, no units, no units completed): No Pass means that neither units nor grade points have been earned. Units for which NP is given are not to be used in calculating grade point averages.

RD — Report Delayed — (no grade points, no units completed): The “RD” symbol may be assigned by the Registrar only. It is to be used when there is a delay in reporting the grade of a student due to circumstances beyond the control of the student. It is a temporary notation to be replaced by a permanent symbol as soon as possible and shall not be used in calculating a grade point average.

W — Withdrawal — (no grade points, no units attempted, no units completed): A “W” grade indicates that the student has withdrawn from college or dropped from a class section prior to the specified drop date. The grade indicates the course has been cancelled from the student’s program of study without credit and is not included in the grade point average calculation. (See Withdrawal Policy)

MW — Military Withdrawal — (no grade points, no units attempted, no units completed): A “MW” means the student is a member of an active or reserve United States military service and was forced to withdraw because of military orders. Students shall be permitted to withdraw upon verification of such orders. Students must submit a copy of their orders to the Admissions and Records Office. Military withdrawal shall not be counted in progress probation or dismissal calculations.

Lapse of Time

Students may repeat a course where the student has received a satisfactory grade and there has been a “significant lapse of time” since completion of the class. Cypress College has defined a “significant lapse of time” as five (5) years. Students must submit a Petition for Exception to the Admissions and Records Office to request such a course repeat. Petition forms are available at the Admissions and Records Office.

Pass/No Pass Grading

The Pass/No Pass (P/NP) grading option was designed to encourage students to explore courses in areas where they feel they have an interest but no special competence. Some of these courses may be taken for a letter grade.

P/NP is not the same as auditing and students who plan to transfer to a four-year institution should not choose the Pass/No Pass grading option. Many transfer institutions will not accept Pass/No Pass graded courses to be applied toward major, minor and general education requirements. Check the catalog of the transfer institution and/or see a counselor for further information. *The following policies govern Pass/No Pass grading at Cypress College:*

P — **Pass** will reflect performance equivalent to a “C” or better under the letter grade system. Pass (P) grades will award units completed but will not be computed into the grade point average.

NP — **No Pass** will reflect performance not equivalent to a “C” or better under the letter grade system. No Pass (NP) grades will not be counted into the grade point average but will enter into calculations for progress probation and progress dismissal.

- Students that choose the grade option of Pass/No Pass may enroll in up to six units each semester, however, a maximum of twelve units of Pass/No Pass courses (excluding COUN 140 C and work experience) will be allowed at Cypress College.
- All units earned as Pass/No Pass shall be disregarded in determining a student’s grade point average at Cypress College.

- The units earned on a Pass/No Pass basis shall be counted toward the AA or AS 60-unit requirement.
- If a course is transferable with a letter grade, it may be also transferable with a credit grade subject to the limitations imposed by the transfer institution. See the catalog of the transfer institution and/or a counselor for further information.
- The option for Pass/No Pass is irreversible once the Pass/No Pass form is processed by the Admissions and Records Office.

A Request for Pass/No Pass form must be completed by the student and instructor. The student must submit the white copy of the form to the Admissions and Records Office by the fifth week of a semester length class and 30% of short term, open entry and Summer classes. If the form is not filed by the deadline, the instructor will be required to assign the student a term grade other than Pass/No Pass.

IB (International Baccalaureate) Examination Credit

Please refer to External Exam Credit Area of this catalog. For information on general education credit earned for various exams see a counselor for clarification and additional information.

International Transcript Evaluations

Students who have attended colleges and universities outside of the United States and believe they have successfully completed courses applicable to the Associate Degree or Certificate requirements must have their transcripts evaluated by an approved international evaluation agency before credit can be determined. A list of approved agencies is available in the Counseling, Admissions and Records and International Student Offices. Students who desire credit for ENGL 100 C will need to have their transcripts evaluated, achieve a satisfactory score on the English Assessment test and meet with a counselor.

Non-Degree Credit Courses (Basic Skills)

These courses are intended to help students gain the skills they need to perform in “college level” courses. Therefore, Non-Degree Credit courses are not applicable toward the Associate Degree. However they **do apply** toward the following categories: Athletic Eligibility, Social Security Benefits, Work Study and Financial Aid, Associated Student Body Office and Full-Time Status.

The following are *Non-Degree Credit* courses:

| | |
|---|---|
| CHEM 060 C Chemistry Review | ESL 044 C Beginning Oral Skills |
| DMS 060 C Introduction to Sonography | ESL 051 C Intermediate Pronunciation |
| ENGL 027 C Basic Study Skills | ESL 052 C Intermediate ESL Grammar 1 |
| ENGL 057 C Reading and Writing I | ESL 053 C Intermediate ESL Grammar 2 |
| ENGL 058 C Reading and Writing II | ESL 054 C Intermediate Oral Skills |
| ENGL 060 C College Writing Preparation | ESL 062 C Advanced ESL Grammar 1 |

| | |
|-------------------------------------|--|
| ESL 063 C Advanced ESL Grammar 2 | HS 030 C Calculations for Medications |
| ESL 064 C Advanced Oral Skills | HS 070 C Health Care Communication |
| ESL 066 C Advanced ESL Reading | MATH 010 C Basic Mathematics |
| ESL 080 C Low Intermediate ESL 1 | MATH 015 C Pre-Algebra |
| ESL 081 C Low Intermediate ESL 2 | MATH 020 C Elementary Algebra |

All other Cypress College courses are degree applicable.

Petitions and Appeals

Petitions for extenuating circumstances and general appeals that relate to policies on admissions, readmission after academic dismissal, graduation, degree and certificate requirements, grades and credit, repetition of courses, academic renewal, withdrawals, etc., should be directed to the Admissions and Records Office. Guidelines and procedures will be made available.

1. **ACADEMIC APPEALS:** Inevitably, with as many interpersonal transactions as occur on a college campus, disagreements with instructors may occur. Should that be the case, a student may take the following procedures:

PROCEDURES

- a. Discuss the matter with the appropriate staff member, preferably in private, and try to resolve the issue.
- b. Consultation with your counselor may also be helpful. If the problem cannot be resolved at that level, the following due process procedures are available to the student.
- c. Consultation with the Student Advocate at Associated Students may also be helpful. The Student Advocate is an elected member of the Student Government who can help the students to follow the procedures in presenting grievances.
- d. Students in vocational programs may need to see the department coordinator/director. Programs that deal with patient/client safety and accrediting agencies have additional policies located in their program handbooks and regulations.
- e. Students who have not been able to resolve classroom problems through an interview with their instructors and the department coordinator/director may consult with the division dean.
- f. If the problem is not resolved to the student's satisfaction the student may file an appeal with the Campus Petitions Committee. Petition forms are available from the division deans or from the Office of Instruction.
- g. A student dissatisfied with the result of his/her appeal to the Campus Petitions Committee may appeal to the College President.
- h. Student appeals from the College President may go to the District Chancellor.
- i. Students dissatisfied with their appeal to the District Chancellor may make a final appeal to the District Board of Trustees.

2. **ADMISSIONS AND RECORDS APPEALS:** Appeals regarding College decisions or policies may be made through the Admissions and Records Office. Appeals include matters relating to admissions, a student's records, application or registration deadlines, grades and credit, repetition of courses, academic renewal, tuition and withdrawals, and readmission after dismissal from the college.

PROCEDURES

- a. Obtain the appropriate form from the Admissions and Records Office.
- b. Fill out the form giving all background information regarding the appeal and listing all specific extenuating circumstances. It is often helpful to obtain a supporting comment from a counselor or instructor and include that with the petition. If available, attach supporting documents.
- c. Submit the petition to the Admissions and Records Office. Note that the petitioner has certain responsibilities in this process. If an appointment for a personal interview is necessary, the student will be notified.
- d. A decision on the petition will be rendered by the Admissions and Records Office.
- e. Students can contact the Admissions and Records Office to determine the petition results.
- f. A copy of the petition and the written decision will be mailed to the student. The student shall execute the appropriate action as directed.
- g. Appeals of Admissions and Records Office decisions may be made through the Executive Vice President of Educational Programs and Student Services.

Probation and Dismissal Policies

In accordance with state regulations, the following probation and dismissal policies have been established. The primary purpose is to ensure that a student is making satisfactory progress toward an educational objective and to alert the student and the student's counselor to the possible need for additional counseling and/or special services.

PLACEMENT ON SCHOLASTIC PROBATION

Academic Probation — A student who has attempted at least 12 semester units at the college shall be placed on *academic probation* if the student has earned a cumulative grade point average below 2.0 in all units taken at the college.

Progress Probation — A student who has enrolled in a total of at least 12 semester units at the college shall be placed on *progress probation* when the student receives grades of "W," "I," "NC" or "NP" in 50% or more of all units for which the student has enrolled at the college.

The college will make a reasonable effort to notify students who are placed on scholastic probation at the end of each term. Students who are on probation shall be automatically considered conditional registrants, and their programs are subject to adjustment and/or restrictions.

REMOVAL FROM SCHOLASTIC PROBATION

Academic Probation — A student shall be removed from academic probation when the student's cumulative grade point average in all units completed at the college is 2.0 or higher.

Progress Probation — A student shall be removed from progress probation when the percentage of "W," "I," "NC" or "NP" units drops below 50% of all units for which the student has enrolled at the college.

STANDARDS FOR SCHOLASTIC DISMISSAL

Academic Dismissal — A student who has been placed on academic probation shall be subject to dismissal if the student has earned a cumulative grade point average of less than 2.0 in all units attempted in each of two (2) consecutive semesters excluding summer sessions.

Progress Dismissal — A student who has been placed on progress probation shall be subject to dismissal if the cumulative percentage of units for which entries of "W," "I," "NC" or "NP" reaches or exceeds 50% for two consecutive semesters.

Summer sessions shall be excluded from the consecutive semester criteria.

The college will make a reasonable effort to notify a student who has been scholastically dismissed not later than the beginning of the Fall semester each year. Scholastic dismissal will be noted on the student's academic transcript.

READMISSION AFTER SCHOLASTIC DISMISSAL

A dismissed student may be considered for readmission after filing a Dismissal Petition in the Admissions and Records Office. After the petition is reviewed, the student will be notified by email of an approved or denied decision.

If readmitted:

- Students are considered conditional registrants and their programs are subject to adjustment and/or restrictions.
- Students readmitted after academic dismissal will remain on academic probation until they achieve a cumulative grade point average of 2.0 or higher.
- Students readmitted after progress dismissal will remain on progress probation until the cumulative percentage of "W," "NC," "I" and "NP" grades is less than 50% of all units attempted.
- Failure to maintain the required academic and/or probation criteria to remain enrolled may result in a subsequent dismissal.

Proficiency Examination

READING

Proficiency in reading may be satisfied by ENGL 096 C, ENGL 102 C, ENGL 102HC, ENGL 103 C, ENGL 104 C, ENGL 104HC or ENGL 106 C, by CSU general education certification or IGETC certification, or by a satisfactory score on the Cypress College reading proficiency examination, or a Bachelor's Degree from a U.S. regionally accredited institution.

The *Reading Proficiency Examination* is administered by the Assessment Center. No units are given for passing this examination, nor is the 60-unit requirement to complete the Associate Degree lowered. **The Reading Proficiency exam may be taken only once after completion of English 100 C or equivalent.**

Students should contact the Assessment Center for dates and times at (714) 484-7223.

MATHEMATICS

A satisfactory score on the Mathematics Proficiency Examination waives the three-unit Mathematics General Education Requirement for the Associate Degree (Category B2). No units are given for passing the Mathematics Proficiency Examination, no units are posted to the student's permanent record, nor is the total number of units required to complete the Associate Degree reduced. Refer to the Mathematics section in the Class Schedule. The Mathematics Proficiency Examination is given only once a semester (usually the sixth week) and can only be taken once (pass or fail). Both a MATH 020 C and a MATH 040 C Proficiency Exam will be administered. Students are advised to check with a counselor to see which test they need in order to meet the graduation requirement based on the year of their catalog rights.

Remedial Limitation

The State of California has implemented a regulation limiting the number of units students can earn for remedial/pre-collegiate basic skills courses to 30 semester units. In accordance with those guidelines, the North Orange County Community College District has established the following policy (AB 1725 Chapter 973, Statutes of 1988).

PRE-COLLEGIATE BASIC SKILLS COURSES

Pre-Collegiate/basic skills courses are defined as those two or more levels below college-level English and one or more levels below intermediate algebra. The North Orange County Community College District has designated certain courses as remedial/pre-collegiate basic skills courses. These courses include reading, writing, computation, learning skills, and study skills designed to ensure acquisition of those skills necessary for successful completion of associate degree, transfer and occupational courses.

INFORMING STUDENTS

Students shall be informed of the Policy for Remedial Limitation. Courses included will carry an appropriate designation in the *Class Schedule* and the Policy will appear in the *College Catalog*. Students enrolling in these courses will be informed of the limit during the matriculation/orientation process and instructors will be required to include this information in the course syllabus. These courses do count toward financial aid, work-study and athletic eligibility.

PROCEDURES DURING REGISTRATION

A non-exempt student who has completed 20 units in designated remedial/pre-collegiate basic skills courses shall be notified of the regulation limiting the number of remedial units. Information on the waiver and referral process will also be included.

EXEMPTIONS

All remedial courses taken by students enrolled in ESL (English as a Second Language) courses are exempted. Students identified by the District for learning disabled programs are also exempted. When, because of closed enrollment, students are unable to enroll in the next higher level ESL course, they do not lose their exemption status. Students with documented disabilities may petition the Admissions and Records Office for exemption status on a case by case basis.

Students transferring to the North Orange County Community College District from other colleges/universities will begin with a clean slate with regard to the remedial limitation. However, since remediation is totaled within a district, students transferring between Cypress and Fullerton College will carry their remedial units with them. Only those courses taken at a regionally accredited college/university, that are determined to be associate degree level courses or higher, will be applied toward an AA/AS degree within the district.

NOTIFICATION

Upon completion of 30 units in designated basic skills courses, non-exempt students shall be notified that they will be unable to enroll in any additional remedial courses. Information on the waiver and referral process will also be included.

WAIVER

Students who show significant, measurable progress toward the development of skills appropriate to enrollment in college-level courses may petition the Admissions and Records Office for a waiver of the limitation on remedial course work. Students will receive a response, in writing, indicating the granting/denial of the petition. If the petition is granted, students will be informed of the specific period of time or the specific courses approved beyond the 30-unit limit. Students will not be allowed to enroll in courses beyond the 30-unit limitation without a waiver, which will only be granted in extenuating circumstances for students who show significant, measurable progress. The 30-unit maximum enrollment limitation is based on end-of-term units earned with any grade.

ENROLLMENT LIMITATION

Students who do not attain full eligibility status for college-level work within the 30-unit limit will not be permitted to enroll in remedial/pre-collegiate basic skills courses unless a waiver is granted. Students will be referred to adult education non-credit courses per State regulations. The Admissions and Records Office will explain to students their enrollment limitation status at the end of the semester.

REINSTATEMENT

A student may, upon successful completion of appropriate remedial course work or upon demonstration of skills levels, which will reasonably assure success in college-level courses, petition to be reinstated to proceed with college-level course work. The petition is to be filed with the Admissions and Records Office.

Review and Release of Student Information

In accordance with Title V (California Code of Regulations) and the provisions of the Federal Family Educational Rights and Privacy Act (FERPA) of 1974, the North Orange County Community College District has established an official policy for student review of and release of student records and students are guaranteed the right to the privacy of their records. This policy allows for the student to review his or her records after contacting the Admissions and Records Office. The policy also describes when student records will be released to a third party and allows the release of student directory information unless the student informs the Admissions and Records Office that he/she does not want such information released.

This policy is available for student review and includes:

- the types of student records and information maintained;
- the official responsible for the maintenance of each type of record;
- the policies for reviewing and expunging records;
- the right of each student to access of his or her records;
- procedures for challenging the content of student records;
- the cost of producing copies of records;
- the categories of information designated as directory information;
- the locations of any required logs or records;
- definitions of officials and employees and legitimate educational interest; and
- the right of a student to file a complaint with the United States Department of Health, Education and Welfare.

Any student wishing to review this policy in its entirety may do so by contacting the Admissions and Records Office.

Privacy Release

Pursuant to the Federal Family Educational Rights and Privacy Act (FERPA) of 1974, the North Orange County Community College District has established Board Policy 5040 (BP 5040) — Student Records Privacy, which covers the release of student records. The college may make public, without prior student consent, only certain directory information. This information will consist of the student's name, major field of study, participation in officially recognized activities and sports, weight and height of members of athletic teams, dates of attendance, degrees and awards received, the most recent previous public or private school attended by the student, and any other information authorized in writing by the student.

Students who wish to have this directory information further restricted may do so on the online College Application for Admission or by making the request in the Admissions and Records Office.

No other student information will be disclosed without prior student consent except to college officials and employees of the District with legitimate educational interests unless pursuant to a court order or lawfully issued subpoena, or as otherwise authorized by applicable federal and state laws.

A copy of the District policy is available on the District website, www.nocccd.edu.

Study Load

Most full-time students take 12–14 units. Students must take a minimum of 12 units to be classified as full-time. The maximum load for any student is 16 units, exclusive of work experience and guidance classes. Exception to the 16-unit maximum may be available with counselor approval. It may be pertinent for students to consider the semester unit requirements under the Classification of Students for particular privileges and activities.

Classification of Students

Students are classified as follows:

| | |
|-----------|-------------------------------------|
| Full-time | Enrolled in twelve or more units |
| Part-time | Enrolled in fewer than twelve units |
| Freshman | Fewer than thirty units completed |
| Sophomore | Thirty or more units completed |

Associated Student Office — six or more units per semester.

Athletic Eligibility — twelve units per semester, including Physical Education classes.

Financial Aid — Full-Time: twelve units per semester; $\frac{3}{4}$ time: nine units per semester; $\frac{1}{2}$ time: six units per semester.

Social Security Benefits — twelve units per semester.

Veterans Benefits — Full-Time: twelve units per semester; $\frac{3}{4}$ time: nine units per semester; $\frac{1}{2}$ time: six units per semester.

Work Study — twelve units per semester required.

The faculty recognizes it is necessary for many students to work while attending college. However, it is expected that students demonstrate good judgment when enrolling under these conditions. Students must make allowance for their employment and other outside obligations in planning their college programs.

In order to maintain a proper academic balance, students should consider the following:

- Students should normally expect to spend at least three hours (one in class and two outside of class) per week for each unit taken.
- Employment and college time together should not exceed sixty hours weekly.
- Students should distribute study time appropriately for each class. Often preparation for a lecture class differs from preparation for a laboratory class.
- Students should take advantage of instructor office hours to consult with faculty as often as necessary.

Transcripts

HIGH SCHOOL TRANSCRIPTS

All matriculated students should have official transcripts sent to the Admissions and Records Office from their high school.

OTHER COLLEGE TRANSCRIPTS

Students with previous college units should have transcripts from all colleges attended sent to the Cypress College Admissions and Records Office. These transcripts can verify completion of prerequisite courses, eliminate the necessity of taking all or part of the placement tests, and can assist the academic counselors when working with the students. Official transcripts from other colleges are required for evaluation of an associate degree, certificate, and meeting general education requirements for transfer.

CYPRESS COLLEGE TRANSCRIPTS

The Admissions and Records Office prepares and permanently retains a record of each student's academic work. The transcript reflects all academic work attempted at Cypress College. It lists chronologically the courses, units, grades, grade points, cumulative grade point average, total units and other relevant academic data.

The normal processing time for transcripts is within 7–10 business days. Forms for requesting transcripts may be downloaded from the college website (www.CypressCollege.edu) and are available in the Admissions and Records Office. Transcript requests may be submitted in person or mailed.

Mail requests must include the student's current and previous names, date of birth, eight-digit student number, approximate dates of attendance, number of copies needed, a complete address where the transcript is to be sent with the student's full signature. Instructions for special handling should be included. Transcript requests should be mailed to Cypress College, Admissions and Records/Transcripts, 9200 Valley View St., Cypress, CA 90630. Requests with incomplete information will not be processed. Additional processing time may be needed when the campus is closed.

Students are entitled to two (2) copies of their transcripts without cost. Subsequent copies are \$3.00 per copy. On-Demand transcripts can be obtained for an additional \$10.00. (*Note: Fee is subject to change at any time.*)

Transcript requests must include full payment to be processed. Only checks or money orders are accepted and should be made payable to Cypress College. *Cash payments can be made at the Admissions and Records Office but are not recommended to be sent through the mail.* Requests will not be processed if the student has holds or outstanding financial obligations to the college.

Cypress College provides students the capability of sending transcripts electronically to other California colleges and universities. This web-based exchange system is secure and provides instantaneous delivery versus that of postal mail. Access the Main Menu in myGateway/Webstar for more information and the list of the participating institutions that can be sent an electronic transcript.

In accordance with the Family Educational Rights and Privacy Act (FERPA) of 1974 and the provisions established in Board Policy BP 5040 of the North Orange County Community College District records may not be released to a third party without prior written authorization by the student.

Students must submit an Authorization to Release Education Records form and a copy of their photo ID to the Admissions and Records Office prior to the release of a transcript to a third party. The form can be obtained from the Admissions and Records Office or downloaded from the Admissions link on the college website. Contact the Admissions and Records Office for additional information.

Withdrawal

It is recognized that, on occasion, students' circumstances might force them to withdraw from a class prior to its completion. It is the student's responsibility to initiate withdrawal procedures. Failure to officially withdraw from a class can result in a grade of "F" or "NP" being assigned.

Effective May 2009, many of the processes for course withdrawal related to course repetition have changed for California Community Colleges. In order to comply with the recent revisions of Title 5, students are advised to see an academic counselor prior to withdrawing from a course.

For the purpose of this policy, a "W" indicates that the student has withdrawn from a course without affecting the student's grade point average. A "W" is given, therefore, under the following conditions and in the manner prescribed below:

SEMESTER COURSES

First Two Weeks of the Semester

A student or instructor may initiate a withdrawal. No notation shall be made on the student's academic record.

Third Week through Twelfth Week

The student or instructor may initiate a withdrawal. A "W" shall be recorded on the student's academic record.

Remainder of Course

The student may no longer withdraw from college after the twelfth week. The academic record of the student shall reflect a symbol or grade other than "W." Under extenuating circumstances, a "W" may be granted after the twelfth week if the student files a Petition for Exception that is approved by the Admissions and Records Office.

SHORT TERM COURSES

Until the Day Prior to the First Census

The student or instructor may initiate a drop. No notation shall be made on the student's academic record. Contact the Admissions and Records Office or see the deadlines printed under the CRN in the class schedule.

From the First Census Through the Withdrawal Date

The student or instructor may initiate a withdrawal up to the time three-fourths of the course has elapsed. A "W" shall be recorded on the student's academic record. Contact the Admissions and Records Office or see the deadlines printed under the CRN in the class schedule for specific courses.

Remainder of the Course

A student may no longer withdraw from classes after the withdrawal date. The academic record of the student shall reflect a symbol grade other than "W." Under extenuating circumstances, a "W" may be granted after the withdrawal date if the student files a Petition for Exception that is approved by the Admissions and Records Office.

WEEKEND SEMINARS

Until the Day Prior to the First Day of the Seminar

The student or instructor may initiate a withdrawal. No notation shall be made on the student's academic record.

After the Seminar Begins

The instructor may drop, with a "W," those students who do not attend the seminar. Those who do attend must receive a symbol or grade other than a "W." Under extenuating circumstances, a "W" may be granted after the withdrawal date if the student files a Petition for Exception that is approved by the Admissions and Records Office.

SUMMER INTERSESSION COURSES

First Week

Students are to check with the Admissions and Records Office for appropriate withdrawal dates or see the deadlines printed under the CRN in the class schedule.

Open-Entry Courses

As often as possible, open-entry courses shall be treated according to the regulations for semester courses. Contact the Admissions and Records Office for further information.

Distance Education Program

Distance education is college instruction in which the instructor and student are separated by distance and communicate with the assistance of technology. These courses provide the same quality of Cypress College instruction, teach the same material, are transferable to most four-year baccalaureate institutions, and require the same fees as our traditional in-person classes.

To take a distance education course, students need access to a computer with an Internet connection and have a functioning email address. Distance education students must, at a minimum, be able to:

- Send and receive email with attachments
- Receive private email with attachments (no shared email accounts)
- Use a word processing program
- Save documents
- Navigate and search the Internet
- Install new software applications

Absences in a Distance Education course are accounted for by monitoring academic attendance or attendance at an academically-related activity. A student will be considered to be “present” in a course if there is evidence of weekly participation in an academically-related activity including, but not limited to, physically attending in-person sessions of a hybrid course, submitting an academic assignment, taking an exam, substantively participating in a course online discussion, study group, or other synchronous or asynchronous activity, or by initiating contact with the instructor in matters related to the course.

A student will be considered “absent” when there is no evidence of participation in an academically-related activity for the course for more than one week or if the student accumulates a consecutive or non-consecutive lack of academically-related activities of more than a week that is more than the number of times the class meets per week. For example, in a three-unit online class that would typically meet on campus three hours a week, one week’s worth of missed academically-related assignment(s) or activity(ies) could be grounds for dismissal. A student who has not submitted assignments or participated in an academically-related activity for one week may be dropped from the course. It is the responsibility of the instructor to define grounds for dismissal in the Distance Education course syllabus.

Online Courses

Online courses have no in-person classroom instruction. All instruction is online.

Hybrid Courses

Hybrid courses are taught both in person and online. While a class may not meet every week, those meetings that are scheduled will be listed in the schedule of classes.

Course Offerings

The Cypress College Class Schedule includes detailed information regarding the distance education courses being offered each academic term, including prerequisites, fees, or other program requirements.

To enroll in a distance education course, students must follow the standard campus registration procedures for any Cypress College course.

Visit the Distance Education Program website for answers to Frequently Asked Questions (FAQ), specific hardware and software requirements, tips for student’s success and more: <http://www.CypressCollege.edu/academics/DistanceEducation>.

Instructional Support Services

Please refer to the index for policy location.

Business and Computer Information Systems Lab

The Business and Computer Information Systems Lab is equipped with computers with a wide range of business application software. The Business and Computer Information Systems Lab (B-202) is available for business students who are concurrently enrolled in courses that require the use of the lab for enhancing and developing business skills. Please refer to the *Class Schedule* for hours of operation.

NORMAL HOURS OF OPERATION:

| | |
|---------|------------------|
| MON–THU | 9:00 am– 9:00 pm |
| FRI | 9:00 am– 1:00 pm |

English as a Second Language Program

Cypress College offers special classes in English for students who are non-native speakers of English. The classes are designed to improve reading, writing, listening and speaking skills. Students will have an opportunity to better understand the U.S. culture. They will also learn how to take exams, write essays and do transfer-level college reading and writing assignments. Individualized lab assignments will further build language skills.

Library and Learning Resource Center

Visit our website at www.CypressCollege.edu/lrc

First Floor Instructional Support: Learning Resource Center (LRC)

The **Learning Resource Center Open Lab** offers students a computer lab where they may access the Internet, software applications (such as word processing, spreadsheet, and presentation) and course-specific software assigned by their instructors (CD-ROM and online). Also available are flatbed scanners with accompanying photo-editing software. *Students may also use a broad variety of academic support media placed in the LRC by instructors. Some assistance using computers and applications is provided. Electrical power, data and wireless connectivity is also available for students with personal laptop computers. The L/LRC has laptops available for students to checkout.

*Pay for print service for all printing and copies.

NORMAL HOURS OF OPERATION:

| | |
|-----------------------|------------------|
| MON–THU | 8:00 am– 9:00 pm |
| FRI | 8:00 am– 5:00 pm |
| SAT, SUN AND HOLIDAYS | CLOSED |

Individual Tutoring is available in the LRC at no cost to CC students. To schedule an appointment with a tutor, call (714) 484-8095 or (714) 484-7193. Normal hours of operation vary depending on tutor availability.

TUTORS ARE AVAILABLE:

| | |
|-----------------------|-------------------|
| MON–THU | 9:00 am– 7:00 pm |
| FRI | 10:00 am– 3:00 pm |
| SAT, SUN AND HOLIDAYS | CLOSED |

Free online tutoring is also available for up to seven hours per semester. For access, click the Smarthinking link on the College's home page.

The English Success Center (ESC) LRC-126

The English Success Center (ESC) provides students with free supplemental learning opportunities designed to improve academic reading and writing skills. Staffed by trained tutors as well as Cypress College English, reading, ESL faculty, the ESC offers directed learning activities (DLAs), faculty-led workshops, and informal learning groups. Additionally, students may use ESC computers to write papers for their course work. Limited drop-in English and ESL tutoring is available. For more information please call (714) 484-7322.

NORMAL HOURS OF OPERATION:

| | |
|-----------------------|-------------------|
| MON–THU | 9:00 am– 7:00 pm |
| FRI | 10:00 am– 3:00 pm |
| SAT, SUN AND HOLIDAYS | CLOSED |

Math Learning Center (MLC) Room 127

The MLC provides students assistance in solving problems and in understanding concepts in mathematics, chemistry and physics. Resources include an array of math solutions manuals and computer applications. Students receive free tutorial assistance with DLAs and workshops from math faculty or peer tutors on a first-come, first-served basis. For more information call (714) 484-7193.

NORMAL HOURS OF OPERATION:

| | |
|-----------------------|-------------------|
| MON–THU | 8:00 am– 8:00 pm |
| FRI | 10:00 am– 3:00 pm |
| SAT, SUN AND HOLIDAYS | CLOSED |

Second Floor Instructional Support: Library

Library Website: <http://library.CypressCollege.edu>

Note: Remote access to the library catalog is available through the website. Remote access to the databases or the text-a-librarian service is available to currently enrolled Cypress College students.

The Library maintains a collection of approximately 68,000 books, periodical subscriptions as well as CDs, DVDs, maps, pamphlets, and several databases with selected full-text newspaper, magazine, and journal articles. Students may access the Internet, the library catalog, databases, the TILT academic research tutorial program, and the extensive full-text EBSCO Host periodical database. The L/LRC has laptops available for students to check out.

Library Cards: A current student picture ID card is your library card. You must have your student ID card with you in order to check out materials or look at reserve/textbook materials. The textbook collection must be used in the library, but there are books, DVDs, CDs, pamphlets and paperback books available for check-out.

Group Study Rooms: Eight group study rooms are available. See staff at the reference desk to make a reservation no more than 7 days and no less than 24 hours in advance. Reservations are made on a first-come, first-serve basis.

NORMAL HOURS OF OPERATION:

| | |
|-----------------------|------------------|
| MON–THU | 7:30 am– 9:00 pm |
| FRI | 7:30 am– 1:00 pm |
| SAT, SUN AND HOLIDAYS | CLOSED |

Supplemental Instruction

The Supplemental Instruction (**SI**) Program provides opportunities for students to voluntarily participate in study group sessions for difficult classes. Typically, these sessions are held immediately after the class and therefore, students wishing to utilize this program should keep their schedules free at those times. These study groups are organized and facilitated by **SI** Leaders who are students who have successfully completed the classes in which **SI** is being offered.

Students who participate in **SI** study sessions report increased understanding of concepts and improved study and test-taking skills. Data shows that those students who participate will earn a half to a full grade higher than those who do not participate.

For more information about **SI**, call (714) 484-7323.

Special Programs

Honors Program

The Cypress College Honors Program is designed to encourage talent and ability in highly motivated students as

they begin their academic studies and prepare to transfer to a four-year college or university. Students who complete the Honors Program and meet all major transfer requirements will have priority consideration for admission to specific four-year institutions.

Classes are taught by faculty interested in enriching the students' academic experience with special projects, readings and class activities. The Program provides a unique, seminar environment with close academic and social interaction with outstanding faculty and other highly motivated honors students. Guest speakers, cultural events and field trips enhance the challenging and creative learning experience.

The Transfer Alliances

Cypress College is a member of the Honors Transfer Council of California. This group has established transfer alliance agreements with four-year colleges and universities.

Honors Courses

| | | |
|------------|---|---|
| ANTH 101HC | Honors Biological Anthropology | 3 |
| ANTH 102HC | Honors Cultural Anthropology | 3 |
| ART 112HC | Honors Survey of Art History II | 3 |
| ASTR 116HC | Honors Introduction to Astronomy | 3 |
| ASTR 117HC | Honors Astronomy Laboratory | 1 |
| BIOL 101HC | Honors General Biology | 5 |
| COMM 100HC | Honors Human Communication | 3 |
| COMM 220HC | Honors Rhetoric of the City | 3 |
| COUN 135HC | Honors Leadership | 3 |
| COUN 160HC | Honors University Transition | 1 |
| ECON 100HC | Honors Principles of Economics | 3 |
| ECON 105HC | Honors Principles of Economics | 3 |
| ENGL 100HC | Honors College Writing | 3 |
| ENGL 102HC | Honors Introduction to Literature | 3 |
| ENGL 103HC | Honors Critical Reasoning and Writing | 4 |
| ENGL 104HC | Honors Critical Analysis and Literature | 4 |
| ENGL 125HC | Honors Film | 3 |
| ENGL 234HC | Honors Shakespeare | 3 |
| ETHS 101HC | Honors American Ethnic Studies | 3 |
| GEOG 100HC | Honors World Geography | 3 |
| GEOL 100HC | Honors Physical Geology | 3 |
| HIST 110HC | Honors Western Civilizations I | 3 |
| HIST 111HC | Honors Western Civilizations II | 3 |
| HIST 112HC | Honors World Civilizations I | 3 |
| HIST 113HC | Honors World Civilizations II | 3 |
| HIST 170HC | Honors History of the United States I | 3 |
| HIST 171HC | Honors History of the United States II | 3 |
| INDS 120HC | Honors Theme Seminar | 1 |
| MUS 118HC | Honors Introduction to Opera | 3 |
| PHIL 100HC | Honors Introduction to Philosophy | 3 |
| POSC 100HC | Honors United States Government | 3 |
| PSY 101HC | Honors Introduction to Psychology | 3 |
| PSY 161HC | Honors Probability and Statistics | 3 |

| | | |
|------------|--------------------------------------|---|
| SOC 101HC | Honors Introduction to Sociology | 3 |
| SOC 161HC | Honors Probability and Statistics | 3 |
| THEA 107HC | Honors Diversity in American Theater | 3 |

Requirements for Entrance

- Minimum 3.25 GPA in high school course work or a minimum of 3.0 GPA in 6 units of college course work, verified by transcripts.
- Eligibility for ENGL 100 C.
- Completion of the Honors Transfer Program application.

To Continue in the Program

- Achieve grades of "C" or higher in all Honors classes.
- Maintain a minimum 3.0 GPA in all Cypress College course work.
- Complete a minimum of one Honors Course each semester.

To Complete the Program

- Complete six (6) Honors designated classes for a minimum eighteen (18) units.
- Complete COUN 160HC Honors College/University Transition and INDS 120HC Honors Theme Seminar.
- Complete the requirements necessary to be accepted by the transfer school in your major.
- Complete two extracurricular activities and a Service Learning component each semester.

Benefits for Students while Enrolled

- Increased Scholarship opportunities.
- Small classes with a seminar environment.
- Special counseling and advisement with the Honors Program Director and Honors Counselor.
- Library privileges at transfer colleges and universities.
- Invitation to special Honors Forums, seminars and social events.
- Honors Club Membership.
- Membership opportunities with Alpha Gamma Sigma Honors Society.

Benefits of Completion of the Program

- Priority consideration for admission at the junior level to selected four-year colleges and universities.
- Special recognition at Commencement.
- Honors notation on transcripts.

Applying to the Program

- Submit an application to the Honors Program Office. Applications are available in the Transfer Center or online at www.CypressCollege.edu/academics/specialprograms/honors.
- Submit a current transcript and proof of eligibility for English 100 C.

For more information please contact:
 Penny Gabourie, Honors Program Counselor
 pgabourie@CypressCollege.edu
 Kathryn Sonne, Honors Program Director
 ksonne@CypressCollege.edu
 Honors Program Office is located in the Transfer Center
 Located in the Student Center
 (714) 484-7452 www.CypressCollege.edu

International Students

Cypress College welcomes applications for its International Student Program. Our college is authorized under federal law to enroll non-immigrant alien students. One of the goals of the program is to provide positive educational opportunities for students in an effort to improve the global community. The staff offers assistance with academic advisement, registration into classes and orienting students to living in Southern California.

- F-1 students are required to pay a non-resident tuition and enrollment fee. This fee is determined by the NOCCCD Board of Trustees each year and is due at the time of registration.
- Only persons who qualify for F-1 student visas are eligible for admission.
- Deadlines for the acceptance of applications from international students are July 1 for the Fall semester and December 1 for the Spring semester.
- The fee for the necessary special handling and processing of the application package of non-resident F-1 students is \$40.00.
- The F-1 visa student is required to complete a full-time program (12 units or more) each semester of attendance and maintain a 2.0 GPA.
- **Criteria for acceptance of International Students:**
 1. The applicant must possess knowledge of the English language sufficient to result in a Test of English as a Foreign Language (TOEFL) score of 500 (written), 173 (computerized), or 61 (IBT, Internet-Based TOEFL). Students already in the United States may take the Cypress College assessment test.
 2. The applicant must offer evidence of a degree of academic achievement the equivalent of an American high school education, twelve years of elementary and secondary school, or be at least 18 years of age. The student must submit a transcript of an official school record accompanied by a notarized English translation.
 3. The applicant must offer evidence of financial responsibility.
 4. The applicant who has attended other American schools or colleges may be considered for admission provided the applicant meets Cypress College admission requirements and can show proof of a valid immigration status with the U.S. Citizenship and Immigration Services (USCIS).
 5. After the completion of the above requirements, the applicant will be considered for admission and will be notified of his/her acceptance or non-acceptance. If accepted, the applicant will also be sent a SEVIS I-20 form and registration information.
- F-1 visa students are held to the same scholastic requirements and to the same college policies and regulations as other students.

- F-1 visa students must enroll in the health and accident insurance policy mandated by the college. The policy includes major medical coverage, repatriation and evacuation. Students without health insurance will not be able to register each semester.
- F-1 visa students will not be accepted for admission into any program when applications by qualified U.S. citizens exceed space available.

F-2 Dependents

Effective May 29, 2015, F-2 visa dependents (spouses and children) can now enroll in study at a SEVP-certified school so long as the study remains less than a full course of study. F-2 dependents remain prohibited, however, from engaging in a full course of study unless they apply for, and DHS approves, a change of nonimmigrant status to a nonimmigrant status authorizing such study.

Legacy Program

Established in 2000, the Cypress College Legacy Program is the first community college program in Orange County to focus on the study of the African-American experience. Set in a supportive academic environment, students create close bonds with peers, professors, and Cypress College staff as they participate in a variety of events on and off campus. The two-semester program is designed to offer under-represented students an opportunity to transfer successfully to a four-year institution and to excel in university-level work. Legacy combines academic, community, and mentoring components to foster a positive, well-rounded college experience.

Legacy students are enrolled in special sections of core courses with the goal of completing a minimum of four transfer eligible courses while in the program.

ENGLISH — Legacy students take **English 060 C and English 100 C** consecutively. These classes work to improve students' basic written language skills and to help them develop research methods and critical reading and thinking skills.

COUNSELING — Legacy students also take **Counseling 150 C and Counseling 160 C** consecutively. These classes help Legacy students improve their study skills, explore career options, develop an academic educational plan, and identify lifetime goals.

ETHNIC STUDIES — While taking English 100 C, Legacy students will be concurrently enrolled in **Ethnic Studies 129 C**. These classes offer complementary curriculum so students will be able to take material they learn from both classes to improve their knowledge, appreciation, and understanding of the African-American experience.

MATHEMATICS — Once Legacy students complete the math placement test administered by the Assessment Center at Cypress College or by another college, they will be placed in a mathematics course that corresponds to their tested skill level.

MENTORING — The Legacy Program matches each student with a mentor from the Cypress College faculty and staff who will offer guidance, support, and encouragement during the program year.

SPECIAL ACTIVITIES — Students participate in Legacy sponsored campus and community programs and events throughout the year. The Legacy Program is an excellent opportunity for students to learn about African-American history and culture while developing the skills necessary to be a successful college student. Contact Dean Eldon Young at eyoung@CypressCollege.edu to enroll in this special program.

Puente Program

Puente (Spanish for “bridge”) is a national award-winning program that helps students reach their dreams of college success. For more than 25 years, the Puente Program has improved the college-going rate of tens of thousands of California’s educationally underrepresented students. Established in 1996 at Cypress College, the mission of the Puente Program is to increase the number of educationally underserved students who enroll in four-year colleges and universities, earn college degrees, and return to the community as mentors and leaders to future generations. Co-sponsored by the University of California and the California Community Colleges, Puente is open to all students eligible for English 060 C and COUN 150 C.

Puente’s interdisciplinary approach combines writing, counseling, and mentoring in a two-semester program.

ENGLISH — Puente students take two consecutive writing classes, **English 060 C and English 100 C**, to improve their written language skills, enhance their research methods, and develop critical thinking while exploring Latino issues in a supportive and stimulating environment.

COUNSELING — Puente students take two consecutive counseling classes, **Counseling 150 C and Counseling 160 C**, to improve their study skills, explore career options, develop an academic educational plan, and identify lifetime goals.

MENTORING — Puente students are matched with a Mentor from the college or professional community who shares her/his personal, academic, and career experiences to provide a window into “real life” work environments. Puente students also work with Peer Mentors, Puente Program graduates, who offer tutoring, guidance, support, and encouragement.

SPECIAL ACTIVITIES — Puente students participate in a number of events on and off-campus, including dinners, a graduation banquet, and guest speakers; field trips to the theater, museums, and bookstores; tours of universities and botanical gardens, and student-organized beach bonfires. These special activities are designed to enrich students’ educational, cultural, and social opportunities.

For more information on joining this award-winning program, please contact Dr. Therese Mosqueda-Ponce, Puente Counselor at (714) 484-7180 or tmponce@CypressCollege.edu or Prof. Kathryn Sonne at ksonne@CypressCollege.edu.

Service Learning

Service Learning is a teaching method that promotes student learning through active participation in meaningful and planned service experience in the community that is directly related to the course content. Through reflective activities, students enhance their understanding of course content, general knowledge, sense of civic responsibility, self-awareness and commitment to the community.

- Incorporate community service into your general education courses
- Apply course skills in a realistic environment
- Explore career options in a course setting
- Increase civic awareness of the community
- Experience a hands-on teaching method
- Strengthen the ethic of service
- Transfer service learning hours to a four year institution

For more information please contact:

Kathryn Sonne, Service Learning Director
ksonne@CypressCollege.edu

Service Learning Office is located in the Transfer Center
 Located in the Student Center
 (714) 484-7452 www.CypressCollege.edu

Special Admit Program

The Special Admit Program is intended for K–12 students who wish to enroll part time in **advanced scholastic or vocational** classes while concurrently enrolled at another school.

To be eligible for the Special Admit Program during the Summer session, Fall or Spring semesters, students must complete the Special Admit Form obtaining required recommendations and signature from the principal with parental or guardian permission and approval from a Cypress College counselor. In certain circumstances the signature of a division dean and the college president is required.

Special Admit students are required to meet all college admission requirements, attend assessment/orientation and meet course prerequisites. Special approval is required for full-time enrollment, persons under age eighteen who are/are not enrolled in school, and home school students. Enrollment into specific courses where content is deemed not appropriate for minors by the department may also require special approval. Students on F-1 or F-2 visas are not eligible to enroll as Special Admit students.

Enrollment fees are waived for California resident Special Admit students in grades 9–12 who are enrolled in .5–11 units. Per Education Code 76300 Special Admit students registered in more than eleven units per semester are required to pay enrollment fees for all enrolled units. Special Admit students who are in grades K–8 are required to pay the enrollment fees for all enrolled units. Students who do not pay the required fees may be dropped from courses for non-payment. All Special Admit students are responsible for all other college fees including lab, health, parking, books, materials and other required fees.

To change enrollment status at the college, Special Admit students graduating from high school prior to the next college semester must bring to the Admissions and Records Office their diploma or high school transcript indicating their graduation date.

Courses taken by a Special Admit student are recorded on the student's permanent record as college credit in the same manner as regularly enrolled college students. Credit may be given at the high school and may meet a graduation requirement; however, students should first consult with the high school counselor. Special Admit students must adhere to all college policies on admission, registration, course requirements, attendance, Student Code of Conduct, and all other applicable policies and procedures.

Students wishing to enroll under the Special Admit Program can download the Special Admit Recommendation Form from the college website or obtain it from the Admissions and Records Office. The Special Admit Recommendation Form is valid for the current semester only. A new Special Admit Form must be submitted for enrollment in subsequent semesters. Students must also file the online College Application for Admission by accessing the college website and applying on CCCApply.

All student records are protected under the Family Educational Rights and Privacy Act (FERPA) of 1974. *No one (including parents and high school officials) can access confidential information without the student's written consent.*

Study Abroad Program

The Study Abroad Program provides students the opportunity to enrich their educational experience by studying abroad for one semester or for a shorter period of time, depending on course offerings, while earning Cypress College units. The program is designed not only to enrich course content by their location in the country where they are offered, but also to provide students with a multicultural experience by living in a society and environment different from that of the United States.

Classes offered will be taught by Cypress or Fullerton College instructors, ensuring complete transferability to other United States colleges. There is an application process for interested students, with prerequisites, interviews, and the final selection. Interested students may contact the Humanities Division. For further information, contact Eldon Young at (714) 484-7177.

Teacher Preparation Program

Program Code: 1T07860

The Teacher Preparation Program at Cypress College is a comprehensive student services program that provides academic support, specialized counseling, and outreach to students who are interested in pursuing a career in teaching. The primary purpose of the program is to provide Cypress College students with a clearinghouse of information and resources to help them become teachers. The program also provides early fieldwork experience in an educational setting. The program offers special classes called Teacher Preparation Classes. These classes are designated with an apple in the Class Schedule. These classes are designed to enhance the future teachers' understanding by providing a variety of different experiences in the classroom related to the field of Education.



TEACHING CREDENTIAL PREPARATION

There are several types of credentials offered by the state of California that students can receive. Students interested in teaching at the elementary school level will be obtaining a Multiple Subject Teaching Credential. The students interested in teaching at the middle school or high school level will earn a Single Subject Teaching Credential. Most California Teaching Credentials take five years to complete on a full-time basis. The required lower division courses may be completed at Cypress College. For more information, log on to the California Commission on Teaching Credentialing website at: www.ctc.ca.gov.

CALIFORNIA BASIC EDUCATIONAL SKILLS TEST (CBEST)

The CBEST verifies proficiency in reading, mathematics, and writing. Passing the CBEST is a requirement for obtaining a teaching credential issued by the California Commission of Teacher Credentialing and is required prior to student teaching. It is strongly recommended that students seeking a teaching credential take the CBEST after completing category A and B4 in the CSU/GE Requirement or Area 1 and Area 2 in the IGETC/GE Requirements. CBEST review classes are offered periodically throughout the year. Check the Class Schedule for specific dates. Students should pass the CBEST before leaving Cypress College. For more information about the CBEST exam, log on to www.cbtest.nesinc.com.

CALIFORNIA SUBJECT EXAMINATIONS FOR TEACHERS (CSET)

All applicants for an elementary teaching credential must prove they are knowledgeable and competent in the subject area(s) they will be licensed to teach. For the middle or high school teacher, subject matter competence focuses on a particular subject such as English or Math. The secondary teaching credential does not require the CSET as long as the student is in an "approved program" and majors in the same subject of their credential. For the elementary teacher, subject matter competence must be demonstrated for all subjects relevant to the elementary classroom through the CSET exam. The exam is divided into subtests (most exams have three subtests) and the examinee has five hours to complete it. Passing the CSET is required for those students who pursue the multiple subject credential. For further information, visit the CSET website at: www.cset.nesinc.com.

CSULB (ITEP) ELEMENTARY PROGRAM AND CSUF (STEP) ELEMENTARY PROGRAM

The Teacher Preparation Program curriculum fulfills all the lower division requirements for the CSULB (ITEP) and CSUF (STEP) Integrated Teacher Education Programs. Upon completion of the integrated program, a student will meet requirements for both a B.A. in Liberal Studies and preliminary multiple subject teaching credential for teaching grades K through 8th, without having to enroll in a year-long credential program. Applications and further information are available in the Teacher Preparation Program Office in the Division of Social Sciences, Humanities, Room 238.

MULTIPLE SUBJECT TEACHING CREDENTIAL

A Multiple Subject Teaching Credential authorizes the holder to teach in a “self-contained” classroom, meaning that one teacher teaches all subjects to the same students. A student will earn a Bachelor’s degree, preferably in Liberal Studies or Child Development (but not exclusively), pass the California Basic Education Skills Test (CBEST), complete a multiple subject teacher credential program, pass a U.S. Constitution class, pass the California Subject Examination (CSET), pass the Reading Instruction Competency Assessment (RICA), and obtain a Character and Identification Clearance. All of the California State Universities now have a statewide agreement that they will all use the same 45 units of common core for all Integrated Teacher Preparation Programs in the State of California.

SINGLE SUBJECT TEACHING CREDENTIAL

A Single Subject Teaching Credential authorizes the holder to teach a particular subject at the middle school or high school level. Examples of specific Single Subjects are: Art, English, Health Science, Home Economics, Industrial and Technology Education, Language (other than English), Math, Music, Physical Education, Biological Sciences, Chemistry, Geosciences, Physics, and Social Science. A student will need to earn a Bachelor’s degree (preferably in the subject taught), pass the California Basic Education Skills Test (CBEST), complete a teaching credential program, pass a U.S. Constitution class, pass the Reading Instruction Competency Assessment (RICA), and obtain a Character and Identification Clearance.

EDUCATION SPECIALIST CREDENTIAL (Special Education)

The person holding this credential may work with elementary, middle school, or high school students. An Education Specialist Credential offers the following specializations: Mild to Moderate Disabilities, Moderate to Severe Disabilities, Visual Impairments, Deaf and Hard-of-Hearing, Physical and Health Impairments, and Early Childhood Special Education. A student will need to earn a Bachelor’s degree, pass the California Basic Education Skills Test (CBEST), complete a teaching credentialing program, pass a U.S. Constitution class, pass the California Subject Examination (CSET), pass the Reading Instruction Competency Assessment (RICA), and obtain a Character and Identification Clearance.

INFORMATION

For specific academic advisement at Cypress College, contact the Teacher Preparation Counselor in the Student Center, 2nd floor, Counseling or for all other inquiries, contact the Dean of Social Sciences Division, Humanities Room 238, (714) 484-7185. The Cypress Teacher Preparation website is: <http://CypressCollege.edu/academics/specialprograms/TeacherPrep>.

** Students with a criminal record are strongly recommended to contact the Teacher Preparation office at (714) 484-7185 to find out their eligibility in the program.

NOTE: Students interested in Teaching should use the program code to indicate their area of interest for the Liberal Arts degree.

Student Support Services

The hours listed here are the normal hours of operation for the various offices for the Fall and Spring semesters. The Summer hours may be different (consult the Summer Class Schedule) and all hours are subject to change.

ADMISSIONS AND RECORDS

Admissions and Records is the first contact students will generally have with Cypress College. The Office provides clear and concise information to all members of the community, and admits and registers students in a timely and proficient manner. The Office provides supportive contacts with students, faculty and the administration by maintaining and retrieving student records. The Admissions and Records Office serves as the final evaluator of all certificate and graduation applications, distributes student records (including grades and transcripts) and certifies and reports attendance data to appropriate agencies.

The Admissions and Records Office is located on the first floor of the Student Center. For information, call (714) 484-7346.

NORMAL HOURS OF OPERATION:

| | |
|-------------|------------------|
| MON and THU | 8:00 am– 6:00 pm |
| TUE and WED | 8:00 am– 7:00 pm |
| FRI | 8:00 am– 5:00 pm |

ADULT RE-ENTRY PROGRAM

Learning is a life-long process and the Adult Re-entry Program is available to inspire, guide, educate, and empower individuals returning to school after a gap in their education. Non-traditional students may return to school to take courses to upgrade skills, make career changes, earn a certificate or degree, transfer to a university, or for personal development. We offer counseling, classes, resources, workshops, and referrals to assist individuals as they transition back to school and move toward successful attainment of their educational and career goals. The Adult Re-entry Program is a component of the Career Planning Center located on the second floor of the Student Center Building. For information call (714) 484-7120 or visit our website at: <http://www.CypressCollege.edu/services/counseling/adultReentryProgram.aspx>

NORMAL HOURS OF OPERATION:

| | |
|-------------|------------------|
| MON and THU | 8:00 am– 6:00 pm |
| TUE and WED | 8:00 am– 7:00 pm |
| FRI | 8:00 am– 5:00 pm |

ARTICULATION STATEMENT

Articulation agreements define how courses will transfer from one institution to another. Cypress College maintains major and/or course-to-course articulation agreements with most public universities and many independent colleges and universities in the state of California. The agreements with the public institutions are listed on **www.assist.org** which is the official repository for articulation in the state. Many independent institutions have articulation information available on their websites. In addition, agreements with public and independent institutions are located in the Transfer Center. For more information call (714) 484-7129.

NORMAL HOURS OF OPERATION:

| | |
|---------|------------------|
| MON–THU | 8:00 am– 6:00 pm |
| FRI | 8:00 am–12:00 pm |

ASSESSMENT CENTER

The Assessment Center provides a variety of services to determine skill levels in grammar, reading, and mathematics. The assessment process is one of the core requirements for early registration. The purpose is to place students in courses which match the students' skills, needs, and goals with college courses, programs and services.

Testing available on a walk-in basis. The Assessment Center is located on the second floor of the Student Center. For information call (714) 484-7223.

WALK-IN TESTING TIMES — Fall and Spring

| | |
|---------------|--|
| MON, TUE, THU | 8:30 am– 3:30 pm (last full test must start by 3:30 pm) |
| WED | 8:30 am– 5:30 pm (last test must start by 5:30 pm) |
| FRI | (full test must start by 8:30 am) |

WALK-IN TESTING TIMES — Summer

| | |
|---------|--|
| MON–THU | 8:30 am– 3:30 pm (last full test must start by 3:30 pm) |
|---------|--|

BOOKSTORE

All textbooks and supplies will be available for purchase in the bookstore at least two weeks before each semester or mid-semester class begins. The bookstore also offers special orders for those books that students cannot find in area stores.

The bookstore also offers supplementary educational books and supplies. The supply section offers imprinted Cypress College logo clothing, gifts, greeting cards, and general merchandise.

You may also rent or purchase textbooks and e-books online at: www.CypressCollegeshop.com.

NORMAL HOURS OF OPERATION:

| | |
|---------|------------------|
| MON–THU | 7:45 am– 6:00 pm |
| FRI | 7:45 am–12:00 pm |

For your convenience the bookstore is open the first Saturday at the start of the Fall and Spring Semesters. Hours for the Summer session and holidays will be posted outside the bookstore as necessary and online at www.CypressCollegeshop.com. For additional information call (714) 484-7336.

BOOK BUYBACK

Students may sell their textbooks and certain workbooks back to the bookstore any day.

NORMAL BUYBACK HOURS:

| | |
|---------|------------------|
| MON–THU | 7:45 am– 6:00 pm |
| FRI | 7:45 am–12:00 pm |

BURSAR

The Bursar's Office processes registration payments and registration refunds, accepts deposits and processes requests for expenditures for a variety of areas on campus including Associated Students and all campus clubs, and monitors campus fundraising activities. This office is also responsible for paycheck disbursement and disbursement of scholarship funds. The Bursar's Office is located on the first floor of the Student Center. For information, call (714) 484-7317.

NORMAL HOURS OF OPERATION:

| | |
|---------|------------------|
| MON–THU | 8:00 am– 5:00 pm |
| FRI | 8:00 am–12:00 pm |

CAMPUS SAFETY

The Cypress College Department of Campus Safety is committed to providing a safe campus environment for its students, faculty, and visitors. Campus Safety provides security and safety services to the campus. The department is responsible for crime prevention and personal safety. While this is our primary responsibility, personal safety and crime prevention does rest with each individual. Therefore, each of us must take personal responsibility for our own safety, as well as for the safety of those around us.

Cypress College is among the safest colleges in the country. We strive towards this goal by providing proactive patrol procedures, interaction with the community, and high visibility. We have also established a partnership with the Cypress Police Department. This combination has been successful in solving many of the problems and issues that have been presented to Cypress College members.

Campus Safety provides coverage to the campus 24 hours a day. Campus Safety is located on the Business Building, first floor adjacent to parking lot 1. The Business Office is open 8 am–5 pm; an outside box is available for deposit of citation appeals. Any criminal action or emergency must be reported to Campus Safety at (714) 484-7387.

Cypress College complies with the Standardized Emergency Management System (SEMS) and the National Incident Management System (NIMS) by conducting emergency exercises each semester.

Campus Safety provides escort service upon request at (714) 484-7387. Lost and found items are housed in the Campus Safety Office. Contact Campus Safety to receive information regarding items.

PARKING

Use of Cypress College's general parking lots requires a parking fee. In lieu of a physical parking permit, the College uses a virtual parking system. Students and guests purchase virtual permits online and at kiosks in and around campus. After purchasing a virtual parking permit, students and guests must register their vehicle license plate number to activate the virtual parking permit. Those who purchase semester-length permits may change vehicle license plate numbers online at any time using the website. Day-use vehicle registration is available at kiosks on campus.

Payment for semester permits and registration of plates authorizes students to use any of the seven lots open to student and guest parking, as well as designated spots on Circle Drive. Cypress College semester-length parking permits are also honored at Fullerton College and the Anaheim Campus. Students and guests may also register vehicles using short-term parking machines for \$2 per day. Short-term permits are valid at Cypress College only. Students and guests are not eligible to park in staff spaces. The parking permit does not guarantee a parking space.

See Campus Safety Traffic & Parking Regulations for further questions at: <http://www.CypressCollege.edu/AD/uploads/206/ccparkingregulations.pdf>.

Use of state-designated disabled parking spaces requires proper display of either a valid disabled placard or designated license plates. Disabled parking spaces are prominently marked in blue and white. Vehicles parked in disabled parking spaces must also comply with the requirements noted above, including purchase of a virtual permit and completion of the vehicle license plate registration. Designated disabled parking spaces are available in all campus lots. Individuals who park vehicles in the disabled stalls without proper credentials will be subject to a \$290 citation.

Any vehicle found parked on Cypress College property that has (3) or more unpaid Cypress College parking citations may be towed without notice. Registered owners of the vehicle will be responsible for paying all citations, towing fees, and impound fees prior to the vehicle being released by the impound company.

PARKING ENFORCEMENT AND APPEALS

All campus parking regulations are enforced by the Cypress College Campus Safety Department. All traffic regulations are enforced by the Cypress Police Department. Parking regulations are strictly enforced. **A one-week grace period is provided at the beginning of the Fall and Spring semesters in order for students to obtain permits.** Failure to register your vehicle license plate may result in a parking citation issued by Campus Safety.

Payment of fines or filing of an appeal must take place within 21 days from the date of the citation or the fine will be doubled. Cypress College Parking Regulations are available on myGateway, the Campus Safety webpage, and in the Campus Safety Office on the first floor of the Business Building.

CAREER PLANNING CENTER

What's your Major? What Stage of the Career Development Process are you experiencing? Where will you be 5 years from today? How did you choose your future career? What education do you need to achieve your goals? The Career Planning Center offers services and resources designed to help you answer questions relevant to YOU and make informed decisions about your future. We guide you through the Career Development Stages to help you Learn about you: **Learn about Yourself** (Stage 1), **Explore Your Options** (Stage 2), **Make Good Decisions** (Stage 3), **Plan Your Education** (Stage 4), and **Prepare for Your Career** (Stage 5). We provide resources and tools to help you formulate meaningful goals, navigate life transitions, and further your career and academic success. We offer career counseling, career assessments, career databases, and workshops. The Career Planning Center is located on the second floor of the Student Center Building. For information call (714) 484-7120 or visit our website at: <http://www.CypressCollege.edu/services/cpc>.

NORMAL HOURS OF OPERATION:

| | |
|-------------|------------------|
| MON and THU | 8:00 am– 6:00 pm |
| TUE and WED | 8:00 am– 7:00 pm |
| FRI | 8:00 am– 5:00 pm |

CENTER FOR INTERCULTURAL UNDERSTANDING

The Mission of the Center for Intercultural Understanding (CIU) is to enrich our learning community through intercultural understanding. The goals of the CIU are to 1) celebrate diversity, 2) promote human relations, 3) disseminate information, 4) provide a forum for dialogue, 5) build community relations, and 6) support globalization/internationalization of curriculum. The Diversity Committee, which oversees the CIU, meets monthly during the academic year. For information, call (714) 484-7049 or 7050.

COUNSELING AND STUDENT DEVELOPMENT

The College maintains a complete guidance service, including the orientation of new students to a successful college experience, counseling to meet the educational requirements for various careers, assistance in selection of courses of study, and individual guidance in matters of aptitude and personal adjustment as they are related to the student's vocational and educational objectives.

Each student is assigned a counselor based on a major or area of interest. The counselor assists the student in planning a program of courses and is available to help in other matters affecting the student's progress in college. Regular conferences may be scheduled during each semester to ensure that the student may gain the greatest possible benefit from the counseling service. Counselors can also be reached by email during the semester at onlinecounselor@CypressCollege.edu or through their individual email address listed in the Programs and Course Descriptions section of this catalog under Counseling and Student Development.

Special courses are offered to assist students in gaining the maximum benefit from their college experience. For example, all students enrolled in more than two classes must enroll in *COUN 140 C* or *COUN 140HC* during their first semester of attendance. This course is designed to further help orient students to college life and assist students in their educational and vocational planning. In addition, there are opportunities for students to take mini-guidance courses in *Career and Life Planning*, *Academic and Life Success*, *Career Exploration*, *College/University Transition*, and *Academic Success and College Survival*.

COUNSELING 140 C

First-time students who are taking more than two classes or who plan to earn the Associate Degree, obtain a certificate, or transfer to a four-year college must include *Educational Planning COUN 140 C* in their schedule. This 18-hour course is taught by a counselor and the class is usually comprised of students with similar majors and/or interests. It is designed to assist the first-time college student with adjustments to college and meeting the educational demands of the college. A large component of the curriculum deals with planning the student's program for the following semesters, depending upon whether the ultimate goal is to complete an Associate degree, a vocational certificate, or whether it is to transfer to a four-year college.

DISABILITY SUPPORT SERVICES (DSS)

Cypress College assures accessibility of programs and activities to students with disabilities. Disability Support Services (DSS) has been established to provide supportive services to students with documented disabilities, including learning disabilities, visual, hearing, mobility, psychological, acquired brain injuries, and other medical disabilities. Services are provided in compliance with state and federal legislation to support students with disabilities in meeting their educational and vocational goals.

Qualifying students may receive the following services and accommodations: registration assistance, specialized counseling and program planning, note-taking assistance, alternative testing, adaptive computerized equipment, interpreting services, and learning disability assessment. Other services and accommodations are provided as needed.

Contact Information:

Phone (714) 484-7104
FAX (714) 826-4042

NORMAL HOURS OF OPERATION:

| | |
|-------------|------------------|
| MON and THU | 8:00 am– 6:00 pm |
| TUE and WED | 8:00 am– 7:00 pm |
| FRI | 8:00 am– 5:00 pm |

EXTENDED OPPORTUNITY PROGRAMS AND SERVICES (EOPS)/COOPERATIVE AGENCIES RESOURCES FOR EDUCATION (CARE) PROGRAMS AND SERVICES

The Extended Opportunity Programs and Services (EOPS) is a state and college funded program designed to assist students with economic, linguistic, and educational challenges (as defined by Title V) enroll and succeed in higher education. Comprehensive support services are provided to promote access to colleges, increase retention, and/or transfer to four-year universities and colleges.

These services include:

- Outreach, Recruitment and Specialized Orientation
- Enhanced Tutoring
- Computer Lab with Internet Access
- Specialized Counseling and Advisement
- Priority Registration
- Textbook Service
- Educational Supplies and Materials
- University Application Fee Waivers

The CARE (Cooperative Agencies Resources for Education) program provides additional services and grants to eligible EOPS single parents who are on public assistance.

Through CARE, eligible EOPS students receive supplemental educational support services, such as counseling and advisement; group support; peer networking; help from peer advisors; information and referrals to campus and community-based services or agencies; networking activities specifically designed for low-income single parents; and workshops, including self-esteem, parenting, study skills, and time management. Grants and allowances for child care, bus passes, textbooks and school supplies; transportation costs and other educational support; personal computer access; on-campus meal tickets are provided to enhance the retention, persistence, graduation and transfer rates of these highly motivated students.

If you are a single parent and interested in receiving benefits available to you, contact EOPS/CARE office at (714) 484-7368. The office is located in the Cypress College Complex on the second floor in Room 201.

The EOPS and CARE staff are composed of dedicated professionals and student workers who are committed to seeing you succeed in college. Services are free of charge to all EOPS eligible Cypress College students.

To find out more about us visit our website at: <http://CypressCollege.edu/services/eops/> or come to our office located in the Cypress College Complex, 2nd floor or contact us at (714) 484-7368.

NORMAL HOURS OF OPERATION:

| | |
|-------------|------------------|
| MON and THU | 8:00 am– 6:00 pm |
| TUE and WED | 8:00 am– 7:00 pm |
| FRI | 8:00 am– 5:00 pm |

CalWORKS

The CalWORKS (California Work Opportunity and Responsibility to Kids) program provides services to Cypress College students who are receiving Temporary Aid to Needy Families (TANF).

Through the CalWORKS program, students may be eligible for paid work study opportunities; child care; academic guidance and counseling; ancillary funds for books and supplies; work activity progress report form completion; communication assistance with the Department of Social Services; workshops to enhance living skills; and networking activities.

Staff is not employed by the Social Services Agency (SSA). They are employed by the North Orange County Community College District as advocates of self-sufficiency through education for our students. If you are attending Cypress College and receiving TANF, please contact the CalWORKS office at (714) 484-7237. The office is located in the Cypress College Complex on the second floor in Room 201.

NORMAL HOURS OF OPERATION:

| | |
|-------------|------------------|
| MON and THU | 8:00 am– 6:00 pm |
| TUE and WED | 8:00 am– 7:00 pm |
| FRI | 8:00 am– 5:00 pm |

FINANCIAL AID

Financial aid programs are awarded to eligible students to help pay their college expenses such as books and supplies, transportation, and other necessities. The Cypress College Financial Aid Office encourages all of our students to become informed about the variety of financial aid programs available at our college. Students may apply for the Free Application for Federal Student Aid (FAFSA) online at www.fafsa.ed.gov. For Dream Act students, they may apply online at <https://dream.csac.ca.gov>. Cypress College Federal School Code is 001193.

The Financial Aid Office currently administers the following types of state and federal financial aid programs to our students:

Federal Financial Aid Programs

Federal Pell Grant — Federally funded grants for eligible undergraduate students based on calculated needs.

Federal Supplemental Educational Opportunity Grant (FSEOG) — Federally funded grants for eligible undergraduate students based on calculated needs.

Federal Work Study (FWS) — Federally funded program that allows eligible students to seek employment for on-campus jobs.

Federal Direct Loan (Subsidized and Unsubsidized): Federally administered, low-interest loans available to eligible students.

State Financial Aid Programs

Cal Grants — State-funded award for eligible students from disadvantaged backgrounds, or low-income families who have exceptionally high financial need, to provide them assistance with enrollment fees, living expenses, books, supplies, and transportation. Further information related to Cal Grants available at www.csac.ca.gov.

Board of Governors (BOGW) Enrollment Fee Waivers: State-funded waivers of enrollment fees for eligible students.

Dream Act (AB 540): Several types of state and institutional aid are available to AB 540 students as a result of the California Dream Act. Information, deadlines and application requirements are always updated on the Cypress College Financial Aid Dream Act resource page on the Cypress College Financial Aid Website or by visiting the Financial Aid Office.

Scholarships

The best way to find scholarships:

1. Check with your parent's employer or organizations with which they are affiliated.
2. Check with organizations and business within your community.
3. Check with your college university financial aid and/or scholarship office.
4. Surf the web.

Types of Scholarships:

Merit based Scholarships: Awards based on academic performance and personal achievement.

Merit plus Need Scholarship: Awards based on academic performance and personal achievement, and financial need.

Institution Scholarships: Awards based on criteria set by a private, non-affiliated organization or individual.

Return to Title IV Funds

Recipients of federal aid programs (Title IV grants or Direct Loans) who withdraw completely from the college before completing at least 60% of their enrollment period may be required to repay all or part of aid received. The Financial Aid Office at Cypress College will officially notice the student regarding the amount owed and repayment deadline.

For additional information:

Financial Aid Office
Cypress College Complex, 1st Floor
9200 Valley View Street
Cypress, CA 90630
(714) 484-7114
www.CypressCollege.edu

NORMAL HOURS OF OPERATION:

| | |
|-------------|------------------|
| MON and THU | 8:00 am– 6:00 pm |
| TUE and WED | 8:00 am– 7:00 pm |
| FRI | 8:00 am– 5:00 pm |

FOOD SERVICES — CAMPUS DINING

There are two areas of food services available on campus during day and/or evening hours. At the Student Center location a variety of foods will be available such as pizza, grilled foods, Asian food and daily specials. Seating is both indoor and outdoor. At the "Bookstore Express" location a variety of sandwiches, salads, snack foods, and cold/hot drinks is available for grab 'n' go.

STUDENT CENTER CAMPUS DINING

NORMAL HOURS OF OPERATION:

| | |
|---------|------------------|
| MON–THU | 7:45 am– 8:00 pm |
| FRI | CLOSED |

BOOKSTORE EXPRESS

NORMAL HOURS OF OPERATION:

| | |
|---------|------------------|
| MON–THU | 7:45 am– 8:00 pm |
| FRI | 7:45 am–12:00 pm |

FOUNDATION

The Cypress College Foundation supports the work of Cypress College by raising funds and distributing them through scholarships, loans, grants, and the funding of select college programs and projects. A non-profit, tax-exempt organization, the Cypress College Foundation raises its funds through the *Americana Awards Banquet*, one of the premiere events in North Orange County; the *President's Circle*, composed of some of the very best friends and supporters of Cypress College; the *Cypress College Foundation Golf Classic*; and various other programs and activities, including planned giving. For more information contact the Foundation Office at (714) 484-7126.

NORMAL HOURS OF OPERATION:

| | |
|---------|------------------|
| MON–FRI | 8:00 am– 5:00 pm |
|---------|------------------|

GUARDIAN SCHOLARS

The Cypress Guardian Scholars Program provides a comprehensive support system that meets the academic, personal and financial needs of foster youth attending Cypress College. Program benefits include program orientation, resources for financial aid and grants, academic advising, workshops for career and academic success, friendship and support.

If you are a current/former foster youth and interested in participating in the Cypress Guardian Scholars program call (714) 484-7368. The office is located in the Cypress College Complex on the second floor in the EOPS Office.

NORMAL HOURS OF OPERATION:

| | |
|-------------|------------------|
| MON and THU | 8:00 am– 6:00 pm |
| TUE and WED | 8:00 am– 7:00 pm |
| FRI | 8:00 am– 5:00 pm |

HEALTH SERVICES

As a registered student at Cypress College you are eligible for basic health services at your center. The Student Health Services Center is for the health and wellness of students on campus. Our goal is to promote physical and emotional wellness, prevent illness and injury, provide basic outpatient health services, and to educate students toward taking responsibility for their own health.

There is no charge to see the Physician, Nurse Practitioner, Counselor and/or Nurse. Nominal fees will be assessed for lab tests, immunizations, medications, and special exam procedures. A registered nurse and/or a family nurse practitioner are available at all times. Appointments are recommended to see the doctor, nurse practitioner and counselor. Emergencies are triaged immediately.

All students are covered by an accident insurance policy which provides coverage for accidents while on campus during required attendance and while using college-sponsored transportation to and from college activities (private insurance is primary).

To make use of any of these health services or to get further information, contact the Health Center located on the first floor of Gymnasium II building by calling (714) 484-7361, or stop by the Center.

NORMAL HOURS OF OPERATION:

| | |
|---------|------------------|
| MON–THU | 8:00 am– 6:00 pm |
| FRI | 8:00 am–12:00 pm |

During the summer session Health Services is closed on Fridays.

LOST AND FOUND

Lost items that have been turned in may be claimed at the Campus Safety Office, located in the Business Building, first floor adjacent to parking lot 1.

NORMAL HOURS OF OPERATION:

MON–FRI 7:30 am– 5:00 pm

PATRONS OF THE ARTS

The Cypress College Patrons of the Arts is a non-profit, tax-exempt organization that functions under the auspices of the Cypress College Foundation. It was founded in 1975 to encourage community participation in the college's fine arts programs and exhibits, foster cultural, visual, and performing arts activities at the college, and to raise funds to provide scholarships to talented students in the fields of Art, MAD — Media Arts Design (including Digital Cinema), Dance, Journalism, Music, Photography, and Theater. Please contact the Cypress College Patrons of the Arts at patrons@CypressCollege.edu or (714) 484-7000 ext. 48203 for further information.

STUDENT HOUSING

Housing is not available on the college campus. Students interested in off-campus housing should contact the Student Activities Office for suggested quarters. A listing of available housing is located on a bulletin board in the Student Activities Center. For questions, call (714) 484-7198.

STUDENT SUCCESS AND SUPPORT PROGRAM

The Student Success and Support Program is a set of services provided to all students as a means of ensuring their academic success. It is legally defined as an agreement between the college and its students. This legislation ensures that every community college student will be afforded the same opportunity for services and to achieve academic success. The college goal is to make the institution a place of easy access and success for students to achieve their educational goals and economic gain. The five components or services which create an easy step-by-step process to introduce Cypress College students to higher education are:

Admissions: The information contained in the college application becomes part of the student's official record. This office registers students and records grades, program changes, graduation, and transfer requirements.

Assessment: The purpose is to gather as much information as needed on new students. Counselors review assessment scores, transcripts, current study skills, language skills, goals, majors, career aspirations, and the need for special services. Testing is necessary for a first time student if there are no previous records. Assessing student skills aids in making the best educational choices.

Orientation: Prior to registration, New and Returning students are required to attend a one and one-half hour group orientation/counseling session. During this session the counselor will review the *College Catalog*, *Class Schedule*, services, programs, certificates, degrees, majors, general college procedures, and college regulations. Using test scores, previous transcripts, course prerequisites, and course selection, the counselor and student will develop a 1st semester education plan. Online orientation is available at your myGateway account under the Student Tab. If you do complete the online orientation, you will need to meet with a counselor to complete your 1st semester education plan. After registration, Educational Planning COUN 140 C or 140HC is offered to assist the student in completing their individualized Student Education Plan.

Counseling/Advising: All students are encouraged to visit their counselor and confer with instructors periodically throughout the year. Counselors are also available through their email address, located in the Programs and Course Descriptions section of this catalog under Counseling and Student Development. A Student Educational Plan should be on file in each student's academic record after completion of 15 units. Faculty advising is available through instructors' posted office hours.

Student Progress/Follow Up: Students who excel in their course work are placed on either the Dean's Honor Roll or the President's Honor Roll. Information regarding scholarship and Honors is available within this catalog. Students encountering difficulty in courses are referred to appropriate college services by counselors and instructors. Additional referrals are made to assist students with special needs.

Students may be exempt from certain Matriculation services if they are a graduate from an accredited U.S. college or university with an Associate of Arts degree or higher. However, they will not be eligible for priority registration (Student Success Act 2012).

Student Rights

All matriculated students have the right to challenge or appeal any step in the matriculation process and may:

1. Enroll in any class where prerequisites are met.
2. Challenge course placement decision.
3. Request a waiver of prerequisites for a course, if it is offered, not validated, or if able to demonstrate previous knowledge.
4. File a complaint of discrimination if prerequisites are being applied in a prejudicial manner.

If you have questions regarding any aspect of these services, please contact the Student Success and Support Program Office at (714) 484-7097.

TRANSFER CENTER

The Transfer Center assists students interested in continuing their education at four-year institutions with an emphasis on reaching the historically underrepresented transfer students. The Transfer Center offers students opportunities to meet with representatives from four-year schools for advisement and to attend workshops and transfer fairs. The Transfer Center also has computer programs for student use.

For more information, visit the Transfer Center on the second floor of the Student Center, or call (714) 484-7129.

NORMAL HOURS OF OPERATION:

| | |
|-------------|------------------|
| MON and THU | 8:00 am– 6:00 pm |
| TUE and WED | 8:00 am– 7:00 pm |
| FRI | 8:00 am– 5:00 pm |

Veterans and Service Members

Cypress College is approved as a degree-granting institution for the attendance of veterans under Title 38, United States Code. This includes the programs covered in Chapters 1606, 1607, 30, 31, 32, 33 and 35. The College is also approved to participate in the Cal-Vet Fee Waiver program.

Veterans and/or dependents that plan to enroll in Cypress College and need assistance with their education benefits must visit the Veterans Resource Center (VRC). The VRC is located on the 2nd floor of the Cypress College Complex, room 215. To begin the intake process you must provide your DD214 and Certificate of Eligibility (COE). Incoming Veterans may be required to enroll in COUN 150 C, Academic and Life Success.

The Veterans Resource Center works closely with Admissions and Records, Academic Counseling, Financial Aid, and various Veteran agencies to provide the Veteran with services contributing to a successful educational experience.

For information regarding:

- Priority Registration
- GI bill and educational benefits
- U.S. Vets “Outside the Wire” program
- Academic Counseling
- Cypress College Veterans Organization
- CalVet Fee Waiver program
- Tuition Assistance

Please contact the Veterans Resource Center for a list of required documents.

Veterans Resource Center (714) 484-7150

Veterans Certifying Official — Christy Davis
cadavis@CypressCollege.edu

Veterans Academic Counselor — Robert Grantham
rgrantham@CypressCollege.edu

Veterans Special Projects Coordinator — Juan Garcia
jgarcia@CypressCollege.edu

HOURS OF OPERATION FOR FALL/SPRING

| | |
|-------------|------------------|
| MON and THU | 8:00 am– 6:00 pm |
| TUE and WED | 8:00 am– 7:00 pm |
| FRI | 8:00 am– 5:00 pm |

HOURS OF OPERATION FOR SUMMER:

| | |
|---------|------------------|
| MON–THU | 8:00 am– 6:00 pm |
| FRI | CLOSED |

Availability and hours subject to change at any time

DISABLED VETERANS

Veterans who qualify for educational benefits as disabled veterans may be entitled to special educational benefits. Veterans should contact:

VA Regional Office
Federal Building
11000 Wilshire Blvd.
Los Angeles, CA 90024-3602
(800) 827-1000
FAX (310) 235-6640

Veterans with disabilities are encouraged to pursue services offered through Disability Support Services (DSS), located on the 1st floor of the Cypress College Complex. Call (714) 484-7104 for assistance.

VETERAN DEPENDENTS

Children and spouses of U.S. Veterans with service connected disabilities may be eligible for waiver of college fees and/or Survivors' and Dependents' Educational Assistance (CH 35). For more information visit the Veterans Resource Center located on the second floor of the Cypress College Complex, Room 215. Call (714) 484-7150 for assistance.

LIABILITY

The veteran assumes full liability for any overpayment of veteran's benefits.

All persons receiving educational benefits must see the veteran's academic counselor and complete a veteran enrollment form (VEF) every semester to continue their benefits. In addition, a Student Education Plan (SEP) must be on file by the end of the first semester; otherwise, certification of VA benefits will be delayed for the second semester. This plan must be developed and reviewed by an academic counselor.

NUMBER OF UNITS REQUIRED

The following number of units is required each semester to qualify for educational benefits for educational and training allowance:

| | |
|---------------------|---------------------------|
| *CH 33 Post GI bill | |
| 12 units or more | full allowance |
| 9 – 11.5 units | $\frac{3}{4}$ allowance |
| 6 – 8.5 units | $\frac{1}{2}$ allowance |
| 2 – 5.5 units | $\frac{1}{4}$ allowance** |

*Enrollment in at least 7 units is required to receive housing. Contact the VRC for more information.

**Chapters 32 and 1606 only

Short-term and summer session courses are computed proportionately for payment purposes.

WITHDRAWAL/CHANGE OF CLASSES

Veterans are required to notify the Veterans Resource Center when they stop attending class, withdraw from the college, or add or drop a class. Such changes should be reported immediately after completing the add/drop procedure through myGateway. Failure to comply with this regulation may result in an overpayment of benefits.

VETERANS ACADEMIC PROGRESS

A veteran student whose GPA falls below a 2.0 for one semester will be placed on academic probation. Veterans who are on academic probation may have to enroll in COUN 150 C Academic and Life Success, to aid the transition back into college life. If the veteran student continues to have a GPA below a 2.0 for two consecutive semesters they will no longer be able to receive educational benefits until a marked improvement has occurred. Contact the Veterans Resource Center for more information.

REPEATED CLASSES

Veterans may not receive benefits for a repeat of a course in which a grade of “A,” “B,” “C,” “D,” or “P” has already been earned. Although District policy allows a student to repeat a course in which a “D” grade has been received, the course may be certified for benefits only if this catalog states that a grade of “C” or better in that course is required to earn a degree or meet a prerequisite.

TRANSCRIPTS

All official transcripts of prior college work and military schools, including copies of form DD214 or DD295 covering all periods of military service, must be on file in the Admissions and Records Office by the end of the first semester of attendance at this college. Certification for benefits for the second semester may be withheld if transcripts are not received. For necessary forms, visit the Veterans Resource Center, located on the second floor of the Cypress College Complex. Call (714) 484-7150 for additional information.

Campus Life

Campus Clubs

Students are encouraged to broaden their horizons by participating in club activities at Cypress College. Clubs are organized to involve the student in specialized fields of interest or service to the college and community. The clubs and organizations at the college can be listed in four categories: academic achievement, cultural, special interest, and religious.

MEETING TIMES

The meeting times for all clubs can be obtained from the Office of Student Activities in the Student Center. The following is a complete list of Cypress' campus clubs and organizations:

- Anime Club
- Anthropology Club
- Ashrae Club
- Black Student Union
- Business Economics Club
- Campus Christians
- Charger eSports
- Chemistry Club
- Court Reporting Club
- Creative Arts Guild
- Engineering and Physics Club
- Epic Movement
- Forensic Club
- Gaming Club
- Geography Club
- Honors Club

- Hospitality and Travel Club
- Human Services
- International Club
- Kinesiology Club
- L.E.A.D.
- LGBTQ Club
- Lively Arts Club
- Marine Biology
- Math Club
- MEChA Club
- Muslim Student Association
- Philosophy Club
- Political Science Club
- Psychiatric Technology
- Psychology Club
- STEM Club
- Veteran's Club

ACADEMIC ACHIEVEMENT CLUB

The Honors Club is the college's academic club. Their main goal is to increase and promote academic excellence among students. The clubs provide service to the school and hold fund-raising activities to earn money for scholarships. Sigma Psi is the campus chapter of Alpha Gamma Sigma and the Honors Club is the support club for the Honors Program.

CULTURAL CLUBS

Cultural clubs provide students with an opportunity to experience other cultures as well as to meet students with similar backgrounds. In addition, they provide a link to the political and social events shaping the world of today.

INTEREST CLUBS

Interest clubs provide a place or event for students to share a common interest or a chance to experience something new.

RELIGIOUS CLUBS

Religious clubs promote a particular religion as well as provide a place for students to come together in their faith.

Dress Code

Students are expected to dress in good taste. Attending class or entering any campus building while barefooted or bare-chested is specifically prohibited.

Intercollegiate Athletic Program

The Cypress College Chargers are members of the Orange Empire Conference composed of Cypress, Fullerton, Golden West, Irvine Valley, Orange Coast, Norco, Riverside, Saddleback, Santa Ana, and Santiago Canyon Community Colleges. The Chargers compete in conference competition in the following men's sports: baseball, basketball, golf, soccer, swimming, diving and tennis. Women's intercollegiate sports include: basketball, soccer, softball, swimming, diving, tennis, volleyball, sand volleyball and water polo. Cypress students may participate in football, cross-country, track and men's water polo at Fullerton College.

Athletic eligibility rules and regulations adopted by the conference and the California Community College Athletic Association are rigidly enforced at Cypress College. In general, eligibility rules require an athlete be enrolled in 12 units or more at the time of competition. To compete a second season in a sport, an athlete must complete and pass 24 units with a 2.0 GPA between seasons of competition. These must be completed prior to the beginning of the second season of the sport. Transfers who have participated in athletics at another California community college must complete 12 units at Cypress College before becoming eligible. Since this is only a general guideline and athletic eligibility rules are rather complex, questions regarding eligibility should be referred to the athletic director for clarification.

Inter-Club Council (ICC)

The Inter-Club Council (ICC) is financed by the Associated Students of Cypress College and its chair is an elected, voting member of the Associated Student Council. The Inter-Club Council is composed of a representative from each of the recognized clubs on campus. Its function is to coordinate the activities of the various clubs and to provide an organized channel for club support of, or participation in, major campus events. For information regarding current clubs on campus, and/or the forming of new clubs, please stop by the Student Activities Center.

Publications

OFFICIAL STUDENT PUBLICATIONS

Student publications are approved by the college through authorization of the President of the college and the assignment of a faculty advisor. Such publications are eligible for distribution on campus. All student publications are expected to reflect good taste, be written and edited by students of the college, and conform to editorial policies established by the college. These editorial policies shall include authority of the faculty advisor to exercise the right to disapprove materials with provision for the right of the student appeal to persons designated by the college President. Students who violate this policy shall be subject to suspension and/or expulsion.

UNOFFICIAL PUBLICATIONS

Commercial publications may not be distributed or sold on the college campus without specific permission from the President. Non-commercial publications, student or non-student, not sponsored or approved by the college may be distributed on campus under regulations as established by the college. Such regulations may pertain to hours and places of distribution, littering, the orderly operation of the college, the outrage of public decency, and an identification of the persons and/or organizations sponsoring the material. Unofficial publications which do not meet the criteria listed are considered unauthorized and may not be distributed on campus.

Student Activities

The Student Activities Program at Cypress College is intended to achieve the following objectives:

- to provide opportunities for students in shared governance activities;
- to provide students with the opportunity to create and administer their own organizations;
- to provide a leadership development program for credit that will help students learn the practical application of leadership and organizational theory.

Student Activities is an integral part of college life, and all students are encouraged to take an active role in some phase of the student activities program.

Activities include campus clubs, concerts, special interest programming, community awareness and involvement, club rush, Senior Day, World Fest, and Welcome Back Week. The Associated Students Council participates on Campus and District Shared Governance committees to represent student interests.

NORMAL HOURS OF OPERATION:

| | |
|---------|------------------|
| MON–THU | 8:00 am– 6:00 pm |
| FRI | 8:00 am–12:00 pm |

Student Government

Cypress College is committed to student government with the following objectives:

- promoting cultural, educational and social events
- enhancing and supporting class instruction
- recognizing student government as an integral part in the shared governance structure of the college
- facilitating participation in the college community

The governing body of the Associated Students of Cypress College is the A.S. Council, which consists of the Executive Board, the Student Senate, and the Programming Board. Elections for officers on these boards are held during the Spring and Fall semesters. The Student Activities Center houses the A.S. Council. Meetings of the Council are held on Mondays at 11:30 am and are open to anyone who would like to attend.

The A.S. Council plans, organizes, promotes and finances many activities for the campus. A.S. Council officers serve on campus committees and participate in the California State Student Senate to represent student interests concerning campus, district, and statewide decisions affecting community college students. Campus clubs are part of Inter-Club Council (ICC) which is administered by the A.S. Council. For further information, contact the Associated Students at (714) 484-7198.

Administrative Procedures

The most current Administrative Procedures and Board Policies for the North Orange County Community College District can be found at <http://www.nocccd.edu/Policies/PoliciesAndProcedures.htm#BoardPolicies>.

Administrative Procedures 5500 — Standards of Student Conduct and Discipline

Reference: *Education Code Section 66300, 76030, 76033, 76034, 76036*

Cypress College students are expected to maintain satisfactory standards of citizenship at all times on the campus and in the community. The following are guidelines for minimum student conduct. Students enrolling in the college assume an obligation to conduct themselves in a manner compatible with the College's function as an educational institution.

A student who violates the standards of student conduct shall be subject to disciplinary action including, but not limited to, the removal, suspension or expulsion of the student. Misconduct which constitutes "good cause" for disciplinary action includes, but is not limited to, the following:

- 1.1 Disruptive behavior, willful disobedience, habitual profanity or vulgarity; the open and persistent defiance of the authority of, or persistent abuse of, District personnel, or violating the rights of other students.
- 1.2 Failure to identify oneself when requested to do so by District officials acting in the performance of their duties.
- 1.3 Cheating, plagiarism in connection with an academic program (including plagiarism in a student publication), or engaging in other academic dishonesty.
- 1.4 Dishonesty, forgery, alteration, or misuse of District documents, records, or identification, or knowingly furnishing false information to the District.
- 1.5 Misrepresentation of oneself or of an organization to be an agent of the District.
- 1.6 Causing, attempting to cause, or threatening to cause physical injury or physical or verbal abuse or any threat of force or violence, to the person, property, or family of any member of the college community, whether on or off District property as defined above.
- 1.7 Willful misconduct which results in injury or death to a student or to District personnel, or which results in the cutting, defacing, or other damage to any real or personal property of the District.
- 1.8 Unauthorized entry into, unauthorized use of, or misuse of property of the District.
- 1.9 Stealing or attempting to steal District property or private property on District premises, or knowingly receiving stolen District property or stolen private property on District premises.
- 1.10 Causing or attempting to cause damage to District property, or to private property on District premises.
- 1.11 Unlawful use, sale, possession, offer to sell, furnishing, or being under the influence of any controlled substance listed in the California Health and Safety Code, section 11053 et seq., an alcoholic beverage, or an intoxicant of any kind, or any poison classified as such by Schedule D in Section 4160 of the Business and Professions Code or other State law

defining controlled substance while on District property, or at a District function; or unlawful possession of, or offering, arranging or negotiating the sale of any drug paraphernalia, as defined in the California Health and Safety Code, section 11014.5.

- 1.12 Willful or persistent smoking in any area where smoking has been prohibited by law or by regulation of the District.
- 1.13 Possession, sale, use, or otherwise furnishing of explosives, dangerous chemicals, deadly weapons or other dangerous object including, but not limited to, any facsimile firearm, knife or explosive on District property, or at a District function, without prior written authorization of the Chancellor, college president, School of Continuing Education Provost, or authorized designee.
- 1.14 Engaging in lewd, indecent, or obscene behavior on District property, or at a District function.
- 1.15 Violation of municipal, state, or federal laws in connection with attendance in programs or services offered by the District, or while on District property or at District-sponsored activities.
- 1.16 Soliciting or assisting another to do any act (including the purchasing, transporting or consumption of any controlled substance), while under the supervision of a District official, which would subject a student to expulsion, suspension, probation, or other discipline pursuant to this policy.
- 1.17 Attempting any act constituting cause for disciplinary action as identified in the above sections of this policy.
- 1.18 Committing sexual harassment as defined by law or by District policies and procedures.
- 1.19 Engaging in harassing or discriminatory behavior based on race, sex (i.e., gender), religion, age, national origin, disability, sexual orientation, or any other status protected by law.
- 1.20 Engaging in physical or verbal intimidation or harassment of such severity or pervasiveness as to have the purpose or effect of unreasonably interfering with a student's academic performance, or District employee's work performance, or of creating an intimidating, hostile or offensive educational or work environment.
- 1.21 Engaging in physical or verbal disruption of instructional or student services activities, administrative procedures, public service functions, authorized curricular or co-curricular activities or prevention of authorized guests from carrying out the purpose for which they are on District property.
- 1.22 Stalking, defined as a pattern of conduct by a student with intent to follow, alarm, or harass another person, and which causes that person to reasonably fear for his or her safety, and where the student has persisted in the pattern of conduct after the person has demanded that the student cease the pattern of conduct. Violation of a restraining order shall, without more, constitute stalking under this policy.
- 1.23 Persistent, serious misconduct where other means of correction have failed to bring about proper conduct or where the presence of the student causes a continuing danger to the physical safety of students or others.
- 1.24 Engaging in expression which is obscene, libelous, or slanderous according to current legal standards, or which so incites students as to create a clear and present danger of the commission of unlawful acts on District property, or the violation of the lawful administrative procedures of the District, or the substantial disruption of the orderly operation of the District.

2.0 No student shall be suspended from a college or School of Continuing Education program or expelled unless the conduct for which the student is disciplined is related to college, School of Continuing Education or District activity or attendance.

3.0 Any violation of law, ordinance, regulation or rule regulating, or pertaining to, the parking of vehicles, shall not be cause for removal, suspension, or expulsion of a student.

4.0 The Chancellor shall establish procedures for the imposition of discipline on students in accordance with the requirements for due process of law. The procedures shall identify potential disciplinary actions including, but not limited to, the removal, suspension or expulsion of a student.

5.0 The Chancellor shall establish procedures by which all students are informed of the rules and regulations governing student behavior.

Administrative Procedures 5500 — Student Discipline Procedures

Reference: *Education Code Section 66017; 76030 et seq. Penal Code Section 626.4*

1.0 The purpose of these administrative procedures is to provide a prompt and equitable means to address violations of the standards of student conduct in a manner consistent with requirements of due process of law. Nothing in these procedures is intended to infringe upon the rights of students to engage in the lawful exercise of free expression as protected by the state and federal constitutions and by the provisions of Education Code section 76120.

2.0 Definitions

2.1 **Administrator:** A management employee of the District having significant responsibilities for formulating District policies or administering District programs.

2.2 **District:** The North Orange County Community College District.

2.3 **College:** Cypress College, Fullerton College, and the School of Continuing Education and their respective programs.

2.4 **Student:** Any person currently enrolled as a student at a College or in any program offered by the District.

2.5 **Instructor:** Any instructional employee of the District in whose class a Student subject to discipline is enrolled.

2.6 **Student Discipline Officer:** The official at a College who is responsible for reviewing and processing student discipline matters.

2.7 **President:** The President of Cypress College, the President of Fullerton College, and the Provost of the School of Continuing Education.

2.8 **Day:** A day during which the District administrative offices are open for business. The time limits set forth in these procedures for action by the Student Discipline Officer, President, hearing officer or panel, and Board of Trustees are guidelines; failure to strictly adhere to these time limits shall not invalidate any action otherwise appropriately taken hereunder.

2.9 **Expulsion:** The involuntary removal of a student from the District and all District programs for one or more terms, or permanently, by action of the Board of Trustees.

2.10 **Formal Hearing:** A hearing conducted before a hearing officer or hearing panel in accordance with section 4.0 of these procedures during which the student and the District may call and examine witnesses and present documentary evidence.

2.11 **Informal Hearing:** A meeting between the student and the Student Discipline Officer or designee in accordance with section 3.2.3 of these procedures to discuss the charges and provide the student with the opportunity to respond to the charges orally, or in writing.

2.12 **Suspension:** The involuntary removal of a student for good cause from one or more classes or from the college by the President or designee for a limited period of time, as follows:

2.12.1 **Short-Term Suspension:** Removal from one or more classes for a period of up to 10 consecutive days of instruction;

2.12.2 **Long-Term Suspension:** Long-term suspension may consist of:

2.12.2.1 Removal from one or more classes for the remainder of the academic term;

2.12.2.2 Removal from one or more classes for one or more academic terms; or

2.12.2.3 Removal from all classes and activities of the College for one or more academic terms.

A student placed on suspension from one or more classes may not, for the period of the suspension, be enrolled in any class or program at any College in the District that is substantially similar to the class(es) or program(s) from which the student is suspended.

A student placed on suspension from all classes and activities of a College may not be enrolled in any College or program in the District for the period of suspension.

2.13 **Removal from Class:** The involuntary removal of a student from class by an Instructor for a maximum period of two consecutive class sessions.

2.14 **Removal from Facility:** The involuntary removal of a student by an administrator from a District or College facility, or facility under the control of the District or College for a maximum period of two consecutive days.

2.15 **Disciplinary Probation:** A status between good standing and suspension or expulsion. It covers a stated trial period and disciplinary conditions required of the student. At the end of the trial period, it shall be determined, based on whether the probationary conditions have been met, whether the student is to be returned to good standing, suspended, recommended for expulsion, or subject to other disciplinary action.

2.16 **Loss of Privileges:** Disciplinary action involving the loss of certain student privileges, such as eligibility to participate in extracurricular activities, for a stated period of time.

2.17 **Formal Reprimand:** Written admonition or warning to cease and desist from conduct that has been determined to violate the standards of student conduct. A formal reprimand becomes part of a student's permanent record and is considered in the event of future violations of the standards of student conduct.

2.18 **Informal Reprimand:** An oral admonition or warning to cease and desist from conduct that has been determined to violate the standards of student conduct. A record of the fact that an informal reprimand has been given may be retained as part of a student's record for a period of up to one year and is considered in the event of future violations of the standards of student conduct during the period of retention. It is the

student's responsibility to request that the record be removed upon expiration of the period of retention.

2.19 Withdrawal of Consent to Remain on Campus: Withdrawal of consent by the President or the President's designee for a student or other person to remain on a College campus in accordance with California Penal Code section 626.4 where the College President has reasonable cause to believe that the student has willfully disrupted the orderly operation of the campus.

3.0 Procedures for Implementing Disciplinary Action

3.1 Removal of Student From Class or From a Facility

3.1.1 Removal From Class by an Instructor: An Instructor may order a student removed from class for good cause. Removal shall be for a maximum period of two class sessions, which shall be the day of the removal and the next class meeting.

Removal From a Facility by an Administrator: For good cause, an administrator may order a student removed from a facility for the day of the offense and the next day.

3.1.2 The student shall be advised of the removal and the reasons therefore. The Instructor or Administrator shall immediately report the removal, through established College administrative channels, to the Office of the President and to the Student Discipline Officer for appropriate action and shall submit, through those channels, a written report describing the conduct warranting the removal to the Student Discipline Officer within ten (10) days of the removal.

3.1.3 The appropriate program administrator or the Student Discipline Officer shall conduct a meeting with the student. If the student is a minor, the Student Discipline Officer shall ask the parent or guardian of the student to attend a parent conference with the Instructor, if the removal was from class, or if the removal was from a facility, with the administrator who ordered the removal, as soon as possible. If the Instructor, administrator, or the parent or guardian so requests, the Student Discipline Officer shall attend the conference.

3.1.4 During the period of removal, the student shall not be returned to the class without the concurrence of the Instructor or, if the removal is from a facility, without the concurrence of the administrator who ordered the removal.

3.1.5 Nothing herein shall prevent the President or Student Discipline Officer from recommending further disciplinary action in accordance with these administrative procedures based on the conduct which prompted the removal.

3.2 Suspension or Expulsion

3.2.1 Except in the case of immediate interim suspension as provided in section 3.3 of these procedures, before implementing disciplinary action to suspend or expel a student, the student shall be provided with a written notice of the conduct warranting the discipline, which shall include:

3.2.1.1 The section(s) of the Standards of Student Conduct the student is charged with violating;

3.2.1.2 A brief statement of the facts supporting the charges;

3.2.1.3 The right of the student to an informal hearing with the Student Discipline Officer or designee to discuss the charges, or to respond in writing; and

3.2.1.4 The nature of the proposed disciplinary action.

3.2.2 The notice shall be provided to the student within thirty (30) days of the date on which the conduct occurred or the date on which an Instructor or other official of the District learned of the conduct; or, in the case of continuous, repeated, or ongoing conduct, the notice shall be provided within thirty (30) days of the date of the most recent occurrence. Within five (5) days of receiving the notice, the student may submit to the Student Discipline Officer a written request for an informal hearing, as provided in section 3.2.1.3. In addition to, or in lieu of requesting an informal hearing with the Student Discipline Officer, the student may submit a written response to the charges. Notice is deemed received as of the date it was personally delivered or three (3) days after it was placed in the United States mail.

3.2.3 If the student requests an informal hearing as provided in section 3.2.1.3, the Student Discipline Officer shall hold an informal hearing during which the student shall be given an opportunity to respond orally or in writing to the charges.

3.2.4 Within five (5) days after the informal hearing, or within ten (10) days after the student has received the written notice pursuant to section 3.2.1 and has declined or failed to request a meeting, the Student Discipline Officer shall provide the President with a written recommendation regarding the specific disciplinary action to be imposed, if any, which shall include the factual findings regarding the charges and conclusions as to the standards of student conduct that were violated, if those findings and conclusions differ in any material respect from the initial notice.

3.2.5 Within five (5) days after receipt of the recommendation of the Student Discipline Officer, the President shall render a decision regarding the disciplinary action to be implemented, if any, and shall provide written notice of the decision to the student. The President may accept, modify or reject the recommendation of the Student Discipline Officer.

3.2.5.1 Short-Term Suspension or Lesser Disciplinary Action

Where the decision of the President is to impose short-term suspension or some lesser disciplinary action, the decision of the President shall be final. The written notice to the student of the President's decision shall specify the length of time of the suspension or the nature and duration of the lesser disciplinary action.

3.2.5.2 Long-Term Suspension

3.2.5.2.1 Where the decision of the President is to impose long-term suspension, the student shall have the right to request a formal hearing before the suspension is imposed.

3.2.5.2.2 The written notice to the student of the President's decision shall specify the right of the student to request a formal hearing and shall include a copy of the formal hearing procedures.

3.2.5.2.3 Within five (5) days of receiving the written notice of the President's decision, the student may submit to the President a written request for a formal hearing. Notice is deemed received as of the day it was personally delivered or three (3) days after it was placed in the United States mail. The hearing, if requested, shall be conducted in accordance with the provisions of section 4.0 of these procedures. If the student does not request a hearing within five (5) days of receiving notice, the President's decision shall become final.

3.2.5.2.4 Within five (5) days after receipt of the recommended decision of the hearing officer or panel, the President shall render a final decision regarding the disciplinary action to be implemented, if any, and shall provide written notice of the decision to the student. The President may accept, modify or reject the findings, conclusions and recommendations of the hearing officer or panel. If the President modifies or rejects

the decision of the hearing officer or panel, the President shall review the record of the hearing and shall prepare a new written decision which contains specific factual findings and conclusions. The decision of the President shall be final.

3.2.5.3 Expulsion

3.2.5.3.1 A student may be expelled for good cause where other means of correction have failed to bring about proper conduct or when the presence of the student causes a continuing danger to the physical safety of students or others. Only the Board of Trustees may expel a student.

3.2.5.3.2 Where the decision of the President is to recommend expulsion to the Board of Trustees, the student shall have the right to request a formal hearing before expulsion is imposed.

3.2.5.3.3 The written notice to the student of the President's decision shall specify the right of the student to request a formal hearing and shall include a copy of the formal hearing procedures.

3.2.5.3.4 Within five (5) days of receiving the written notice of the President's decision, the student may submit to the President a written request for a formal hearing. Notice is deemed received as of the date it was personally delivered or three (3) days after it was placed in the United States mail. The hearing, if requested, shall be conducted in accordance with the provisions of section 4.0 of these procedures. If the student does not request a hearing within five (5) days of receiving the notice, the President's decision shall become final.

3.2.5.3.5 Within five (5) days after receipt of the recommended decision of the hearing officer or panel, the President shall render a decision regarding the disciplinary action to be implemented, if any. The President may accept, modify or reject the findings, conclusions and recommendations of the hearing officer or panel. If the President modifies or rejects the decision of the hearing officer or panel, the President shall review the record of the hearing and shall prepare a new written decision which contains specific factual findings and conclusions.

3.2.5.3.5.1 Where the decision of the President is to impose suspension or some lesser disciplinary action, the decision of the President shall be final. The student shall be provided with a written notice of the President's decision which shall specify the length of time of the suspension or the nature of the lesser disciplinary action.

3.2.5.3.5.2 Where the decision of the President is to recommend expulsion, the written recommendation of the President shall be submitted to the Board of Trustees for consideration in accordance with section 5.0 of these procedures. The Board of Trustees shall consider the recommendation for expulsion at the next regularly scheduled meeting of the Board following the meeting at which the recommendation was received.

3.2.6 The College President shall report all suspensions of students to the Chancellor.

3.2.7 Whenever a minor student is suspended, the parent or guardian shall be notified in writing by the President or designee.

3.2.8 In cases of assault, the Chancellor or President shall, upon the expulsion or suspension of any student, notify the appropriate law enforcement authorities of any acts of the student which may be in violation of section 245 of the Penal Code.

3.3 Immediate Interim Suspension

The President or designee may order the immediate suspension of a student where there is reasonable cause to believe that immediate suspension is required to protect lives or property and to ensure the maintenance of order. Where a student is placed on interim suspension, the procedural time limits specified in these procedures shall not apply. The student shall be given prompt notice of the charges and all hearing rights, including the right to a formal hearing where a long-term suspension or expulsion is recommended, shall be afforded the student within ten (10) days of the imposition of interim suspension. The student shall not, without prior written permission from the President or designee, enter the campus of any College other than to attend the hearing. Violation of the interim suspension conditions shall be grounds for expulsion.

3.4 Withdrawal of Consent to Remain on Campus

3.4.1 The President or designee may withdraw consent for a student to remain on the College campus, in accordance with California Penal Code section 626.4, where there is reasonable cause to believe that the student has willfully disrupted the orderly operation of the campus. A student who is on campus at the time consent is withdrawn shall promptly leave or be escorted off campus. Whenever consent is withdrawn by an authorized designee of the President, a written report shall be promptly submitted to the President.

3.4.2 Consent shall not be withdrawn for longer than fourteen (14) days from the date upon which consent was initially withdrawn. The student from whom consent has been withdrawn may submit a written request for a hearing to the Student Discipline Officer. The request must be submitted within the period of the withdrawal. A hearing, if requested, shall be held within seven (7) days of the date of receipt of the request. The hearing shall be conducted in accordance with the provisions of this procedure relating to interim suspensions.

3.4.3 A student from whom consent to remain on campus has been withdrawn and who willfully and knowingly enters or remains upon the campus or facility during the period for which consent has been withdrawn, except for the purpose of attending a meeting or hearing on the withdrawal, is subject to arrest.

4.0 Formal Hearing Procedures

4.1 Hearing Officer or Panel

4.1.1 At the discretion of the President, a formal disciplinary hearing may be conducted using the services of a hearing officer, or the President may select an impartial hearing panel comprised of two educational administrators at the level of dean or vice president, one of whom shall be selected from another college within the District.

4.1.2 The President shall appoint one member of the panel to serve as the chair of the hearing panel. The decision of the chair shall be final on all matters relating to the conduct of the hearing.

4.1.3 No administrator who has any direct involvement in the matter to be decided, who is a necessary witness, or who could not otherwise act in a neutral manner shall serve on a hearing panel.

4.2 Notification of Hearing

The student, and the student's parent or guardian, if the student is a minor, shall be notified by registered or certified mail or by personal service of the date, time, and location of the hearing.

4.3 Conduct of Hearing

4.3.1 Prior to the hearing, the members of the hearing panel shall be provided with a copy of the charges against the student and any written response provided by the student.

4.3.2 The hearing shall be closed and confidential.

4.3.3 The student shall have the right to represent himself/herself at the hearing or to be represented by a person of the student's choice, except that neither the student nor the District shall be represented by legal counsel unless authorized by the hearing officer or panel, in which case both parties shall be entitled to be represented by legal counsel.

4.3.4 A record of the hearing shall be made by the District, either by means of tape recording or stenographic recording, and shall be the only recording made. In the event the record is by means of tape recording, the hearing panel chair shall, at the beginning of the hearing, ask each person present to identify himself/herself by name, and thereafter shall ask each witness to identify himself/herself by name. Tape recordings shall remain in the custody of the District at all times, unless released to a professional transcribing service. The student may receive a copy of the tape recording upon request.

4.3.5 Formal rules of evidence shall not apply. Any relevant evidence shall be admitted.

4.3.6 The hearing officer or panel shall not have the authority to issue subpoenas on behalf of either the District or the student.

4.3.7 Charges against the student, along with supporting evidence from witnesses or other sources, will be presented by the District.

4.3.8 The student shall be given the opportunity to confront and cross-examine witnesses.

4.3.9 The student shall be given an opportunity to present a defense, including witnesses and documentary evidence.

4.3.10 The District shall have the opportunity to cross-examine the student and witnesses called by the student.

4.3.11 Unless the hearing officer or panel determines to proceed otherwise, the District and the student shall each be permitted to make an opening statement. Thereafter, the District representative shall make the first presentation, followed by the student. The District representative may present rebuttal evidence after completion of the student's presentation.

4.3.12 All testimony shall be taken under oath; the oath shall be administered by the hearing officer or hearing panel chair. Witnesses shall not be present at the hearing when not testifying. No witness who refuses to be recorded may be permitted to give testimony. Written statements of witnesses under penalty of perjury shall not be admissible unless the witness is unavailable to testify. A witness who refuses to be tape recorded is not unavailable.

4.3.13 The hearing officer or hearing panel chair may determine that requiring live testimony of a proposed witness would subject the witness to an unreasonable risk of psychological or physical harm. After such a determination, the witness may be permitted to provide a written statement under penalty of perjury in lieu of testifying at the hearing.

4.3.14 The burden shall be on the District to introduce substantial evidence to support the charges against the student.

4.3.15 Within fifteen (15) days following the close of the hearing, the hearing officer or panel shall prepare and submit a written decision to the President. The decision shall include specific factual findings regarding the charges, conclusions as to the standards of student conduct that were violated, and a recommendation regarding the specific disciplinary action to be imposed, if any. Failure of the hearing officer or panel to submit its written decision within fifteen (15) days shall not invalidate the decision.

5.0 Procedures for Consideration of Expulsion by Board of Trustees

5.1 The Board shall hold closed sessions when it considers disciplinary action regarding expulsion of a student. The Board shall notify the student, and the parent if the student is a minor, by registered or certified mail or by personal service of the intent of the Board to call a closed session to consider the expulsion. The notification shall specify the date, time and place of the meeting at which the Board will consider the disciplinary action and shall be provided at least three (3) days prior to the meeting. Final action by the Governing Board may be taken in closed session, provided that the action of the Board shall be reported in public session. The student shall not be identified by name or other designation that would disclose the identity of the student.

5.2 In considering a recommendation for expulsion, the Board may accept, modify or reject the findings, decisions and recommendations of the President and/or the hearing officer or panel. If the Board modifies or rejects the decision of the President and/or the hearing officer or panel, the Board shall review the record of the formal hearing, and shall prepare a new written decision which contains specific factual findings and conclusions. The decision of the Board shall be final. The student, and the student's parent or guardian, if the student is a minor, shall be notified in writing of the Board's decision.

STUDENT RIGHTS AND RESPONSIBILITIES

The California Education Code provides that, "The board shall have the power to adopt such rules and regulations, not inconsistent with law, as are necessary for its own government and to enable the board to carry out all powers and responsibilities vested in it by law" (Section 71020). The Board of Trustees has prescribed the following rules relating to students. These rules shall apply to each of the colleges of the District. Each College President shall be responsible for the development of procedures required on that campus to assure that these rules are in effect on that campus.

1. ACADEMIC FREEDOM POLICY:

A college community, consisting of faculty, students, and administrators, under authority of the Board of Trustees, has as its primary purpose the realization of the students' growth and development through the dissemination and application of knowledge. Because it is only in the open exchange of ideas that this purpose can be achieved, students are encouraged to study any and all issues and problems. Freedom to think, read, question, and speak are necessary to the college community, but such freedoms must be exercised within the rules established under the general policies of the Board of Trustees.

2. STUDENT CLASSROOM RIGHTS AND RESPONSIBILITIES:

- a. Students enrolled in a course accept the instructor's authority in all matters pertaining to the classroom instruction and individual academic performance. Students have the right to:
 - (1) Know the instructor's standards for academic evaluation and classroom conduct.
 - (2) Challenge, with normal courtesy, faculty statements of opinion.
 - (3) Receive professional evaluation of their academic performance.
 - (4) Expect professional treatment of their views, beliefs, or political associations.
 - (5) Have reasonable access to members of the faculty on campus.
- b. Students enrolled in a course accept the responsibility to:
 - (1) Seek diligently to achieve the instructional objectives of the course.
 - (2) Practice honesty and respect the rights of others.
 - (3) Meet instructional and conduct standards as specified in 2.a.
- c. Students who violate the rights of other members of any class shall be subject to removal or suspension from that class.

3. CAMPUS RIGHTS AND RESPONSIBILITIES:

- a. Students have the right to:
 - (1) Participate in the formulation and application of college policy which affects them in accordance with procedures established on each campus under the general policies of the Board.
 - (2) Petition to organize interest groups pursuant to college and Board policies.
 - (3) Join student associations approved pursuant to college and Board policies.
 - (4) Invite and hear speakers as defined in the campus speakers policy.
- b. Students who violate the rights of chartered organizations shall be subject to the rules and regulations as published and distributed on each campus.
- c. Campus publications boards, or their equivalent, shall have the authority and responsibility for all college publications. Their authority and responsibility shall include, but not be limited to, providing written clarification of the role of student publications and the standards to be used in their evaluation. These standards shall be within the canons of responsible journalism and the limitations on control of their operations as established by the faculty advisor.

Prohibition of Harassment

The policy of the North Orange County Community College District is to provide an educational, employment, and business environment including but not limited to access to its services, classes, and programs in which no person shall be subjected to unlawful harassment and where such environment is free from unwelcome sexual advances, requests for sexual favors, sexual favoritism, or other verbal or physical conduct or communications constituting sexual harassment. It shall also be free of other unlawful harassment, including but not limited to harassment that is based on: ethnic group identification, national origin, religion, age, sex, gender, gender identification, gender expression, race, color, medical condition, genetic information, ancestry, sexual orientation, marital status, physical or mental disability, or military and veteran status of any person, or because he or she is perceived to have one or more of the foregoing characteristics. Students and employees who believe they have been harassed or retaliated against in violation of this policy should immediately report such incidents by following the procedures described in Administrative Procedure 3410, Unlawful Discrimination.

The following person is designated by the North Orange County Community College District as the Responsible Officer for receiving and coordinating the investigation of all unlawful harassment complaints, including sexual harassment:

Name: Irma Ramos
 Position: Vice Chancellor, Human Resources
 Address: 1830 W. Romneya Drive
 Anaheim, CA 92801-1819
 Telephone: (714) 808-4826

Title IX and Civil Rights Grievances

NORTH ORANGE COUNTY COMMUNITY COLLEGE DISTRICT NON-DISCRIMINATION STATEMENT

It is the policy of the North Orange County Community College District to provide an educational, employment, and business environment, including but not limited to access to its services, classes, and programs, in which no person shall be unlawfully subjected to discrimination or sexual harassment, nor unlawfully denied full and equal access to the benefits of District programs or activities on the basis of ethnic group identification, national origin, religion, age, sex, gender, gender identification, gender expression, race, color, medical condition, genetic information, ancestry, sexual orientation, marital status, physical or mental disability, or military and veteran status as defined and prohibited by state and federal statutes. Any student who engages in unlawful discrimination or sexual harassment in violation of this policy will be subject to disciplinary action, which may include suspension or expulsion.

The following person is designated by the North Orange County Community College District as the Responsible Officer/Section 504 and Title IX Coordinator for receiving and coordinating the investigation of all unlawful discrimination complaints filed pursuant to section 59328 of Title 5 of the California Code of Regulations, and for coordinating compliance with section 504 of the Rehabilitation Act of 1973 and Title II of the Americans with Disabilities Act of 1990, Title IX of the Education Amendments of 1992, and response to discrimination complaints related thereto:

Position: Vice Chancellor, Human Resources
 Address: 1830 W. Romneya Drive
 Anaheim, CA 92801-1819
 Telephone: (714) 808-4826

Students who believe they have been subjected to unlawful discrimination, including sexual harassment, or who seek information regarding the District's Unlawful Discrimination Policy, should contact the Vice Chancellor of Human Resources.

VICTIMS OF SEXUAL ASSAULT

Students who are victims of sexual assault occurring on District property or on an off-campus site or facility maintained by the District, or who seek information or assistance regarding a sexual assault, should contact the campus Director of Health Services at (714) 484-7045 or the Director of Campus Public Safety at (714) 484-7455. Except as may otherwise be required by law, all inquiries will be maintained in confidence. Victims of sexual assault should immediately report the incident to the Campus Safety Department, Cypress Police Department and the campus Title IX officer. The Title IX Officer for the campus is the Executive Vice President of Educational Programs & Support Services (714) 484-7330. The Title IX Officer for the District is the Vice Chancellor of Human Resources (714) 808-4826.

STUDENT RIGHT TO KNOW CAMPUS SECURITY ACT

Cypress College Rates for Fall 2011 Cohort

Completion Rate: 35.97%

Transfer Rate: 15.70%

California Community Colleges Statewide

Rates for Fall 2011 Cohort

Completion Rate: 27.98%

Transfer Rate: 12.09%

In compliance with the Student Right-to-Know and Campus Security Act of 1990, it is the policy of the North Orange County Community College District and Cypress College to make available its completion and transfer rates to all current and prospective students. Beginning in Fall, 2011, a cohort of all certificate-, degree-, and transfer-seeking first-time, full-time students were tracked over a three-year period. Their completion and transfer rates are listed above. These rates do not represent the success rates of the entire student population at the College nor do they account for student outcomes occurring after this three-year tracking period.

Based upon the cohort defined above, a Completer is a student who attained a certificate or degree or became 'transfer prepared' during a three-year period, from Fall 2011 to Spring 2014. Students who have completed 60 transferable units with a GPA of 2.0 or better are considered 'transfer-prepared.' Students who transferred to another postsecondary institution, prior to attaining a degree, certificate, or becoming 'transfer-prepared' during a five-semester period, from Spring 2012 to Spring 2014, are transfer students.

Student Rights under FERPA for Postsecondary Institutions

FERPA at a Glance

THE FAMILY EDUCATIONAL RIGHTS AND PRIVACY ACT

What is FERPA?

The Family Educational Rights and Privacy Act of 1974, as amended, sets forth requirements regarding the privacy of student records. FERPA governs: (1) release of these records (known as education records) maintained by an educational institution and (2) access to these records. This law applies to K–12 as well as postsecondary education.

Who must comply with FERPA?

Any educational institution (school or other entity that provides educational services and is attended by students) and educational agency (entity that administers schools directly linked to it) that receives funds under any program administered by the U.S. Secretary of Education.

What does FERPA require for educational institutions to be in compliance?

- Notify students annually. Schools must notify students of their rights on an annual basis. There is no specific method that schools must use to notify students; it is up to the institution. Notice must take a form that is "reasonably likely" to notify students. Recommended and most frequently used ways include:
 - Student bulletin, handbook, or catalog
 - School or local newspaper
 - Student registration packet
- Protect students' rights to inspect and review their education records.
- Protect students' rights to request to amend their education records.
- Protect students' rights to limit disclosure of personally identifiable information contained in education records.
- Ensure that third parties do not redisclose personally identifiable information (except under a few circumstances).
- Keep records of requests for and disclosures of student education records in limited situations.

Who has FERPA rights at the postsecondary level?

A student "in attendance" (regardless of age) and former students.

- *Student* applies to all students attending — including continuing education students, students auditing a class, distance education students, and high school students enrolled in college.
- *In attendance* applies to and is determined by the institution. If the institution has not defined when a student is "in attendance" that date becomes the day the student first attends a class at the institution.

What rights does FERPA provide for students?

- Right to inspect and review their education records.
- Right to request to amend their education records.
- Right to limit disclosure of some "personally identifiable information" (information that would directly identify the student or make the student's identity easily traceable) known as *directory information*.

What is considered Directory Information?

Student's name, major field of study, participation in officially recognized activities and sports, weight and height of members of athletic teams, dates of attendance, degrees and awards received, the most recent previous public or private school attended by the student, and any other information authorized in writing by the student. (NOCCCD BP 5040 effective April 2009).

The Family Educational Rights and Privacy Act (FERPA) affords students certain rights with respect to their education records. These rights include:

- (1) The right to inspect and review the student's education records within 45 days of the day the College receives a request for access.

Students should submit to the registrar, dean, head of the academic department, or other appropriate official, written requests that identify the record(s) they wish to inspect. The College official will make arrangements for access and notify the student of the time and place where the records may be inspected. If the records are not maintained by the College official to whom the request was submitted, that official shall advise the student of the correct official to whom the request should be addressed.

- (2) The right to request the amendment of the student's education record that the student believes is inaccurate.

Students may ask the College to amend a record that they believe is inaccurate. They should write the College official responsible for the record, clearly identify the part of the record they want changed, and specify why it is inaccurate.

If the College decides not to amend the record as requested by the student, the College will notify the student of the decision and advise the student of his or her right to a hearing regarding the request for amendment. Additional information regarding the hearing procedures will be provided to the student when notified of the right to a hearing.

- (3) The right to consent to disclosures of personally identifiable information contained in the student's education records, except to the extent that FERPA authorizes disclosure without consent.

One exception, which permits disclosure without consent, is disclosure to school officials with legitimate educational interests. A school official is a person employed by the College in an administrative, supervisory, academic, research, or support staff position (including law enforcement unit personnel and health staff); a person or company with whom the College has contracted (such as an attorney, auditor, or collection agent); a person serving on the Board of Trustees; or a student serving on an official committee, such as a disciplinary or grievance committee, or assisting another school official in performing his or her tasks.

A school official has a legitimate educational interest if the official needs to review an education record in order to fulfill his or her professional responsibility.

Upon request, the College discloses education records without consent to officials of another school in which a student seeks or intends to enroll or is already enrolled so long as the disclosure is for the purposes related to the student's enrollment.

- (4) The right to file a complaint with the U.S. Department of Education concerning alleged failures by *the College* to comply with the requirements of FERPA. The name and address of the Office that administers FERPA is:

Family Policy Compliance Office
U.S. Department of Education
400 Maryland Avenue, SW
Washington, DC 20202-4605

Programs of Study

CERTIFICATE OF ACHIEVEMENT PROGRAMS

A program certificate is a verification of competency designed to make the student proficient and employable in a specific occupational skill. The certificate is awarded independently of the Associate Degree. Students who have maintained continuous enrollment have the option of completing the certificate requirements in effect at the time they initially enrolled or any subsequent catalog up to and including the last semester of attendance. At least 50% of all course work required for a Cypress College Certificate must be completed at Cypress College. All required courses must be completed with a minimum grade of "C." Students wishing to use courses from another institution to meet Cypress' requirements should meet with a counselor to review the necessary petitioning procedure. Program certificates will be noted on student transcripts.

OCCUPATIONAL CERTIFICATE REQUIREMENTS

Certificates do not require general education course work. Requirements for Certificate Programs for the 2017–2018 Catalog Year include:

- Submission of an Application for Certificate in the Admissions and Records Office.
- Completion of specific program courses listed in the catalog with a minimum grade of "C."
- Completion of at least 50% of the required courses at Cypress College.

Students may submit an application for multiple certificates per term providing requirements are met. A catalog academic year must be specified on the application. The catalog year will be used to determine if all certificate requirements have been met. **NOTE:** Specific course requirements for Certificates are listed in applicable sections of the catalog.

ACCOUNTING

Accounting

AIR CONDITIONING AND REFRIGERATION

Air Conditioning and Refrigeration
Air Conditioning Building Commissioning
Air Conditioning Codes and Estimating
Commercial Air Conditioning
Air Conditioning Customer Service
Air Conditioning Environmental Controls
Green Air Conditioning
Heat Pump
Commercial Refrigeration
Green Refrigeration

ART

See Media Arts Design/Multimedia

AUTOMOTIVE COLLISION REPAIR

Advanced Collision Repair Paint Technician
 Advanced Collision Repair — Structural Technician
 Auto Collision Facility Production Manager
 Auto Collision Repair Center Management
 Automotive Collision Center Damage Appraiser
 Automotive Collision Center Office Management
 Automotive Collision Repair
 Automotive Damage Appraisal
 Automotive Paint and Refinishing
 Automotive Sales and Service
 Collision Repair Automotive Sales and Services
 Collision Repair Body Technician
 Collision Repair Center Parts Manager
 Collision Repair I-Car Gold
 Collision Repair Mechanical Technician
 Collision Repair Paint Application Specialist
 Collision Repair Technician Assistant
 Detail Technician
 Insurance Co/Auto Collision Repair Industry Management

AUTOMOTIVE TECHNOLOGY

Automotive Sales and Service
 Automotive Technology
 Brake and Alignment Specialist
 Automotive Technology Electrical Diagnostic Specialist
 Emission Control Specialist
 Engine Specialist
 Automotive Technology Maintenance Technician
 Performance and Driveability Specialist
 Automotive Technology - Toyota Specialist
 Transmission Specialist

AVIATION AND TRAVEL CAREERS

Advanced Airline Customer Services
 Advanced Flight Attendant
 Advanced Travel/Tourism
 Aviation I — Private Pilot
 Aviation II — Instrument Pilot
 Aviation III — Commercial Pilot
 Aviation IV — Advanced Pilot
 Aviation Management
 Basic Airline Customer Services
 Basic Airport Operations
 Basic Cruise Line Sales and Operations
 Basic Flight Attendant
 Basic Tourism and Conference Management
 Basic Travel/Tourism
 Homeland Transportation Security

BUSINESS

Accounting
 Business Management
 Marketing
 Merchandising
 Professional Marketing
 Retail Management (WAFC)

COMPUTER INFORMATION SYSTEMS

Advanced Networking
 Cisco Networking
 Computer Forensics
 Computer and Office Applications
 Computer Programming
 Computer Software and Application
 Cyber Security
 Database Management
 Game Programming
 Java Programming
 Microsoft Excel
 Microsoft Networking
 Network Virtualization
 Office Assistant
 PC/Network Hardware Support
 Project Management
 Social Media Marketing
 Technology Management
 Visual C Programming
 Web Development
 Web Networking Technology
 Web Programming

COURT REPORTING

Captioning
 CART* (Communication Access Realtime Translation)
 Computer Editor (Scopist)
 Court and Agency Services
 Court Reporting
 Court Reporting Technology
 Hearing Reporter
 Legal Administrative Assistant
 Legal Transcription
 Proofreading

DANCE

Dance Teaching

DENTAL

Dental Assisting
 *Dental Hygienist

DIAGNOSTIC MEDICAL SONOGRAPHY

Diagnostic Medical Sonography

ECONOMICS

Business Economics

ENERGY SUSTAINABLE TECHNOLOGIES

*Geothermal Energy
 *Solar Energy
 Sustainable Energy
 *Wind Energy

GEOGRAPHIC INFORMATION SYSTEMS

Geographic Information Systems
 Geographic Information Systems/Marketing

HOTEL, RESTAURANT, CULINARY ARTS

Baking Fundamentals
 Baking and Pastry Arts
 Culinary Arts
 Culinary Fundamentals

Food and Beverage Management
 Food Service Fundamentals
 Hospitality Management
 Hotel Fundamentals
 Restaurant - Lodging Entrepreneur
 Special Event Management

HUMAN SERVICES

Addiction Studies
 Criminal Justice
 Conflict Resolution
 Family Studies
 Gerontology
 Human Services Generalist
 Victimology

MANAGEMENT

Business Economics
 Commercial Music Management
 Business Management
 Professional Marketing
 Project Management
 Retail Management (W AFC)
 Small Business Management
 Small Business Operations

MARKETING

Automotive Sales and Service
 Geographic Information Systems/Marketing
 Marketing
 Professional Marketing
 Small Business Operations
 Social Media Marketing

MEDIA ARTS DESIGN

Animation 2D Computer Graphics
 Animation 3D Computer Graphics
 Computer Graphics
 Digital Cinema Arts and Industry
 Digital Cinema Production
 Digital Cinema Techniques and Technologies
 Electronic Publishing Design
 Multimedia Production Basics
 Post Production Basics for Cinema and Video
 Vector Illustration

MERCHANDISING

Merchandising

MULTIMEDIA

Multimedia Art

MUSIC

Commercial Music Management
 Recording Arts

PHOTOGRAPHY

Advertising and Illustrative Photography
 Creative Photo Arts
 Digital Photo Technician
 Digital Photography
 Photography
 Portrait and Wedding Photography

PHYSICAL EDUCATION

Aerobic Instructor
 Aquatic Specialist
 Athletic Coach

PSYCHIATRIC TECHNOLOGY

Psychiatric Technology

RADIOLOGY

Imaging Technologist Assistant
 *Radiologic Technology

THEATER

Acting and Film Video Production
 Costume/Makeup Design
 Lighting/Audio Design
 Musical Performance
 Technical Theater

* Students must have previously earned an Associate Degree to be eligible for these certificates.

Students with disabilities requiring accommodations on state or national examinations should contact the department coordinator for further information. Requests for accommodations should be made prior to applying for any licensing or certification examination.

DEPARTMENT CERTIFICATES

Some departments offer certificates of accomplishment in specialty areas. Students should see a counselor for specific information about department certificate requirements.

TRANSFER CERTIFICATES

Cypress College offers transfer certificates for students wishing to complete their lower division general education requirements for UC, CSU, and many private universities that accept CSU GE Breadth or IGETC certification of general education completion. Certificate requirements include:

- Submission of a Certificate Application to the Admissions and Records office,
- Receive grades as indicated below for each certificate,
- Complete at least 3 units in residency at Cypress College.

INTERSEGMENTAL GENERAL EDUCATION TRANSFER CERTIFICATION (IGETC): CERTIFICATE OF ACHIEVEMENT

A certificate of achievement will be granted to students who complete a minimum of 37 units from areas 1–6 of the IGETC general education requirements. IGETC requirements are designed to be taken with a major area of concentration and elective courses in preparation for transfer to the California State University or University of California.* To receive this Certificate of Achievement, students should:

- Review the IGETC pattern in this catalog or available from the Counseling Services Center,
- Consult with a counselor to insure they understand and are following all requirements,
- Receive a grade of “C” or better in all classes,

- Verify through their counselor and www.assist.org that classes taken are approved for IGETC the semester they are taken,
- Apply to receive their Certificate of Achievement through the Admissions and Records Office. Note: Students who receive the IGETC Certificate of Achievement do not need to request separate GE Certification; it will be automatically granted and indicated on their transcript if all requirements are met.

Note: Completion of the IGETC requirements alone is not enough to make students eligible for admission to a CSU or UC. *Following the IGETC pattern is not always the best option for students, especially those transferring to highly impacted majors in the CSU or UC system. Please consult with a counselor for details on completing all transfer admission requirements or using course work from other institutions.

CSU General Education (CSU GE) Breadth: Certificate of Achievement

A certificate of achievement will be granted to students who complete a minimum of 39 units from category A through E of the CSU general education requirements. CSU GE requirements are designed to be taken with a major area of concentration and elective courses in preparation for transfer to the California State University.* To receive this Certificate of Achievement, students should:

- Review the CSU General Education Breadth pattern sheet in this catalog or available from the Counseling Services Center,
- Consult with a counselor to insure they understand and are following all requirements,
- Receive a grade of “C” or better in classes taken in areas A1, A2, A3 and B4,
- Verify through their counselor and www.assist.org that classes taken are approved for CSU GE the semester they are taken,
- Apply to receive their Certificate of Achievement through the Admissions and Records Office. Note: Students who receive the CSU GE Certificate of Achievement do not need to request separate GE Certification; it will be automatically granted and indicated on their transcript if all requirements are met.

Note: Completion of the CSU General Education Breadth requirements alone is not enough to make students eligible for admission to a CSU. *Following the CSU GE pattern may not always be the best option for students, especially those transferring to highly impacted majors in the CSU system. Please consult with a counselor for details on completing all transfer admission requirements or using course work from other institutions.

APPLICATION FOR CERTIFICATES

Students may apply for a certificate during the semester they are completing the certificate requirements or thereafter. They do not have to be currently enrolled in Cypress College to apply for a certificate. Those students who have maintained continuous enrollment have the option of completing the certificate requirements in effect at the time they initially enrolled or any subsequent catalog up to and including the last semester of attendance. Students wishing to use courses from another institution to meet Cypress’ requirements should meet with a counselor to determine course equivalency. Applications for certificates are available in the Admissions and Records Office and will be accepted until the deadline. If the application is not filed by the deadline, the student must submit another application and will receive the certificate at a later date. There is no fee for the certificate application. It is the student’s responsibility to provide the Cypress College Records Office with official copies of all transcripts from other colleges that will be used to meet requirements for certificates. The transcripts become the property of the Admissions and Records Office and will not be released. Certificates will be mailed approximately two to three months after the end of the semester in which the student applied and completed the requirements. State approved Program Certificates will be noted on student transcripts. Applications for a Certificate are available in the Admissions and Records office and online at www.CypressCollege.edu. See class schedule for dates of acceptance.

ASSOCIATE DEGREES

Associate degrees are commonly conferred by community colleges. This degree is awarded upon a student’s satisfactory completion of a program of study. Students who have maintained continuous enrollment have the option of completing the Associate Degree requirement in effect at the time they initially enrolled or any subsequent catalog up to and including the last semester of attendance. The Associate Degree is one of two types, the Associate in Arts or Associate in Science. The distinction between the degrees lies in the majors. An Associate in Arts Degree includes at least eighteen units in Social Science, Humanities and Arts courses. An Associate in Science degree includes at least eighteen units in Science, Math and Technical courses.

Graduation Requirements for an Associate Degree

For this catalog year

Graduation requirements for the Associate Degree are prescribed by the California Community Colleges Board of Governors, Title 5 and the North Orange County Community College District Board of Trustees. An Associate Degree may be earned upon satisfactory completion of all of the following:

1. Residence Requirement

Complete 12 units at Cypress College.

2. Local Degrees Graduation Requirements

Liberal Arts Emphasis and Occupational Degrees

- Cultural Diversity
- Physical Activity and Health
- Reading Proficiency

3. General Education Requirements

All students are required to complete general education. Cypress College has three general education patterns:

- Cypress College native general education pattern of 25 units;
- CSU General Education Breadth pattern of 39 units; or
- IGETC (Intersegmental General Education Transfer Curriculum) pattern of 37–39 units.

The appropriate pattern of general education for a specific degree is listed with the major requirements.

NOTE: A passing score on an Advanced Placement (AP) exam, College Level Exam Program (CLEP) exam, or International Baccalaureate (IB) exam may allow a student to receive subject credit for various general education requirements. Please reference the *External Exam Credit* policy section of the catalog for more specifics and see your counselor for questions regarding these policies.

4. Major/Area of Emphasis Requirement

A student must achieve a grade of “C” or better in each course attempted that is counted for the major or area of emphasis. Effective Fall 2008, C- (minus) grades do not satisfy these requirements. At least 50% of the major course work must be completed at Cypress College. (The Liberal Arts Areas of Emphasis in Arts and Humanities, Human Communication, Social and Behavioral Sciences, and Math and Science and the AA-T and AS-T are excluded from the 50% policy.) Each area of emphasis requires a minimum of 18 units. Liberal Arts Area of Emphasis: California community college courses taken to fulfill CSU GE/IGETC requirements may be used to satisfy a Cypress College Area of Emphasis. Courses taken at other regionally accredited colleges and universities may also be considered to meet Liberal Arts Area of Emphasis requirements if they are deemed comparable to CSU GE/IGETC-approved courses.

5. Scholarship Requirement

A cumulative grade-point average of 2.00 (“C”) in all course work attempted.

6. Elective Courses

A student may complete additional degree-applicable classes for a total of 60 units (see Non-Degree Credit Courses for description of classes that are non-degree applicable).

Application for an Associate Degree

Although a student may have completed all requirements, an Associate Degree is not automatic. Students who intend to graduate must file an application with the Admissions and Records Office. Courses taken at other regionally accredited colleges and universities to fulfill General Education requirements may be used to satisfy Cypress College General Education requirements if they are comparable to Cypress College General Education courses or are used in the same category at the sending institution, and are degree applicable at Cypress College. (This policy supersedes all previous catalogs.) All official transcripts from other colleges are required at the time of application and become the property of the Admissions and Records Office and will not be released. Diplomas will be mailed approximately two to three months after the last day of the semester to the most recent address on file in the Admissions and Records Office at Cypress College. Applications for an Associate Degree are available in the Admissions and Records office and online at www.CypressCollege.edu. See class schedule for dates of acceptance.

HONORS AT GRADUATION

In recognition of academic excellence for completion of the associate degree, students are awarded graduation honors as follows:

| | |
|-------------|-----------|
| Honors | 3.30–3.74 |
| High Honors | 3.75–4.00 |

Graduation honors are calculated using all degree applicable course work completed. This includes course work completed at Fullerton College and all other accredited institutions for which an official transcript has been received.

Graduation honors will be indicated in the commencement program and on the student’s diploma and transcript. However, for candidates (those students with final grades pending), the commencement program will note “candidate” as their degrees and honors have not yet been confirmed. When final grades are posted, a recalculation of grades will be completed and, if the student qualifies, the graduation honor will be noted on the diploma and transcript.

Occupational Degree

The Occupational Degree is designed for individuals who desire an Associate in Arts or Associate in Science Degree with an occupational major. This degree may include transfer and/or non-transfer course work (see Course Numbering section for description of transfer and non-transfer course work) and includes completion of major requirements.

Requirements for the Occupational Degree include:

- Completion of 25 units of general education from the Cypress Native GenEd pattern;
- Three (3) units of Cultural Diversity. These units must be chosen from the Cultural Diversity list;
- Completion of Reading Proficiency requirement;
- Completion of Major courses listed in the catalog with a minimum grade of “C.” A minimum of 50% of these courses must be completed at Cypress College.
- Completion of additional degree-applicable classes for a total of 60 units (see Non-Degree Credit Courses for description of classes that are non-degree applicable);
- A 2.0 (C) overall GPA.

Occupational Degrees Offered by Cypress College are:

Accounting
 Air Conditioning and Refrigeration
 Airline Customer Services
 Art — General
 Art — Graphic Design
 Automotive Collision Repair
 Automotive Technology
 Aviation Management
 Baking and Pastry Arts
 Business Management
 Commercial Pilot
 Computer and Office Applications
 Computer Information Systems
 Computer Programming
 Court Reporting
 Culinary Arts
 Dance
 Dental Assisting
 Dental Hygiene
 Diagnostic Medical Sonography
 Energy and Sustainable Technologies
 Pre-Engineering
 Flight Attendant
 Food and Beverage Management
 General Studies (Fine Arts)
 Health Information Technology
 Hospitality Management
 Human Services
 Law Office Administration
 Liberal Arts with Emphasis
 LVN to RN
 Marketing
 Merchandising
 Mortuary Science
 Music
 Photography
 Physical Education
 Psychiatric Technology
 PT to RN
 Radiologic Technology
 Registered Nursing
 Retail Management (W AFC)
 Small Business Management
 Theater Arts
 Travel/Tourism

General Studies Fine Arts**A.A. Degree****Program Code: 1A18452**

The Associate of Art Degree in Fine Arts provides students with a scope of knowledge and broad overview for attaining the communication skills, practical knowledge, and training necessary for a variety of careers in the Fine Arts area. Students completing this degree will develop a basic understanding of the arts and how they interrelate. The Associate of Arts Degree in Fine Arts empowers the student to see Humanities, Math, Science, Engineering, Business and Career Technology through the prism of the arts. Key concepts in general education are reinforced by their connection to the arts. Bridging the wisdom of the ages with contemporary innovations, this program offers a well-rounded education with insight to opportunities in our modern world.

Requirements for the General Studies Degree in Fine Arts are listed under the Interdisciplinary Studies section of this catalog, and include:

- Completion of 25 units of general education;
- Three (3) units of Cultural Diversity. These units must be chosen from the Cultural Diversity list;
- Completion of Reading Proficiency requirement;
- Completion of at least 18 units. (Note: Where appropriate, courses may also be counted for a GE area). At least 50% of all course work must be completed at Cypress College;
- Completion of additional degree-applicable classes for a total of 60 units (see Non-Degree Credit Courses for description of classes that are non-degree applicable);
- A 2.0 (C) overall GPA and a 2.0 (C) in all courses taken in the Area of Emphasis.

Multiple Degrees

A student may earn multiple degrees from Cypress College. However, please note the following:

- Students may earn an Associate Degree for Transfer (ADT) and an Associate Degree (AA) in Liberal Arts with an Emphasis in the same discipline but only if they apply to graduate and complete course work for both degrees at the same time.
- After earning an Associate Degree in Liberal Arts with an emphasis, students may earn an ADT in the same discipline.
- After earning an ADT, students may not earn an Associate Degree in Liberal Arts with an emphasis in the same discipline.
- Students who have already been awarded an Associate Degree or higher from another accredited college or university in, or outside of, the U.S. are not eligible to receive an Associate Degree in the same major from Cypress College. Petitions for exceptions are reviewed on a case-by-case basis.

General Education (Native) Requirements for the Associate Degree

General Education requirements at Cypress College are designed to introduce students to the many ways people comprehend the modern world. The subject matter presented in general education courses is designed to be broad, and frequently introductory, rather than specialized, narrow, or advanced. These courses form a pattern of learning experiences designed to develop the following insights and capacities in all students, regardless of their ultimate educational goals:

- Knowledge of the common principles, concepts, and modes of inquiry in the major disciplines;
- Appreciation and understanding of the environment, culture, society, and self;
- Ability to think and communicate clearly and effectively, critically and ethically both orally and in writing;
- Proficiency in mathematics, natural science, and analytical thinking;
- Understanding of the political and economic environment in order to be better informed and more responsible citizens;
- Desire to continue education throughout their lives.

Courses taken for general education must be on the Native General Education pattern at the time they are taken. Continuing students should check with a counselor in planning completion of General Education requirements. Students entering Cypress College in Fall 1995, or later, must complete 25 units of General Education (of the total 60 degree applicable units required for the Associate Degree) taken from the following areas listed on the next page.

Note: A satisfactory score on the Cypress College reading proficiency test will determine placement into college-level English (**Area A1 below**) or pre-college level course work. Refer to the Class Schedule listed under STEP TWO, ENGLISH ASSESSMENT. A student may attempt to pass the proficiency exam only one time after completion of English 100 C or equivalent.

The mathematics requirement may be met by passing a Mathematics Proficiency Examination (**Area B2 below**). Refer to the Class Schedule for time and date of administration of the Mathematics Proficiency Examination. See Math Proficiency Examination explanation, location can be found in the MATHEMATICS portion of the Class Schedule or the catalog.



CYPRESS COLLEGE

2017-2018

CYPRESS COLLEGE NATIVE (LOCAL) GENERAL EDUCATION REQUIREMENTS

Student's Name: _____ ID#: @ _____ Date: _____

Degree: A.A. _____ A.S. _____ Major _____ Counselor _____

Associate Degree Requirements: Includes fulfillment of both the cultural diversity and reading requirements, major course-work toward an occupational degree (AA or AS), completion of 60 degree eligible units with a minimum grade point average of 2.0 and satisfaction of the 25-unit general education requirement as described in the following list. Courses taken for general education must be on the native AA/AS General Education list at the time they are taken. Students should check with their counselor in planning completion of General Education requirements.

(Check boxes accordingly) LEGEND: C=Completed IP=In Progress R=Remaining

| | CATEGORY A. LANGUAGE AND RATIONALITY 6-UNIT MINIMUM Written Communication must be completed with a grade of "C" or better. | AP CREDIT or OTHER COLLEGE COURSE(S) | C | IP | R |
|------------|---|---|----------|-----------|----------|
| A1 | WRITTEN COMMUNICATION: 3 Unit Minimum ENGL 100C [□] (100HC [□]) | | | | |
| A2 | ANALYTICAL THINKING: 3 Unit Minimum COMM 050C, 100C [□] (100HC [□]), 135C CIS 111C ENGL 103C ^{**□} (103HC ^{**□}), 104C ^{**□} (104HC ^{**□}), 106C ^{**} , 135C PHIL 170C, 172C, 175C (begin F17) | | | | |
| | CATEGORY B. NATURAL SCIENCES AND MATHEMATICS 6-UNIT MINIMUM Mathematics must be completed with a grade of "C" or better. | | | | |
| B1 | LIFE SCIENCES AND PHYSICAL SCIENCES: 3 Unit Minimum ANTH 101C [□] (101HC [□]), 101LC, 210C ASTR 116C [□] /117C [□] (116HC [□] /117HC [□]) BIOL 101C [□] (101HC [□]), 102C, 103C, 107C, 111C/112C, 113C/114C, 122C, 160C, 174C, 175C, 210C, 230C, 231C(begin F06), 241C(begin F06), 276C(begin F16), 277C(begin F16), 278C(begin F16) CHEM 100C, 101C, 103C, 104C, 107C, 111AC, 111BC, 201C(begin F15) GEOG 102C/102LC GEOL 100C [□] /101C (100HC [□])/101C, 100C [□] /115C (100HC [□])/115C, 103C, 105C, 120C, 125C, 130C/131C, 190C PHSC 104C PHYS 130C, 201C, 210C, 211C, 221C | | | | |
| *B2 | MATHEMATICS: 3 Unit Minimum (Courses need a prerequisite of Elementary Algebra or higher) MATH 030C(begin F09), 038C, 040C, 041C, 100C, 110C, 115C, 120C [□] , 130C, 141C, 142C, 150AC, 150BC, 250AC, 250BC PSY 161C [□] (161HC [□]) SOC 161C [□] (161HC [□]) | | | | |
| | CATEGORY C. ARTS AND HUMANITIES 6- UNIT MINIMUM | | | | |
| C1 | ARTS: 3 Unit Minimum ART 100C, 110C, 111C, 112C [□] (112HC [□]), 114C, 120C, 150C, 151C, 182C, 185C, 194C(formerly 189C), 216C DANC 100C, 101C [∞] , 105C, 106C, 107C, 108C, 111C, 112C, 120C, 134C ENGL 125C [□] (125HC [□]) MUS 101C, 103C, 113C [∞] , 116C, 117C, 118C [□] (118HC [□]), 119C, 120C, 127C, 274C, 280C, 282C, 291C; MUSA 104C(formerly MUS 122C) PHOT 101C [□] THEA 100C, 101C, 102C(F95-F10; begin F13), 107C ^{∞□} (107HC ^{∞□}), 108C(formerly 106C), 120C, 126C [□] , 129C, 132C, 133C, 149C | | | | |
| C2 | HUMANITIES: 3 Unit Minimum ANTH 105C(begin F14), 107C CHIN 100C, 101C, 102C, 203C COMM 220C [□] (220HC [□]) ENGL 102C ^{**□} (102HC ^{**□}), 110C, 111C, 126C, 127C(begin F17), 208C, 211C, 212C, 221C, 222C, 234C [□] (234HC [□]), 239C [∞] , 243C, 247C [∞] , 255C [∞] , 256C [∞] , 260C ETHS 130C [∞] (begin F17), 131C [∞] (begin F17), 151C [∞] (formerly 141C) (begin F17), 152C [∞] (begin F17), 160C [∞] (begin F17), 171C [∞] (begin F17) FREN 101C, 102C, 203C, 204C INDS 100C, 101C JAPN 100C, 101C, 102C, 125C, 203C, 204C JOUR 110C PHIL 100C [□] (100HC [□]), 101C, 110C, 120C, 135C(begin F16), 160C, 201C, 202C, 230C, 240C(begin F17) PORT 101C, 102C SPAN 101C, 102C, 201C, 202C, 203C, 204C | | | | |

(Check boxes accordingly) LEGEND: C=Completed IP=In Progress R=Remaining

| CATEGORY D. SOCIAL SCIENCES UNIT MINIMUM | | 6- | AP CREDIT or OTHER COLLEGE COURSE(S) | C | IP | R |
|---|--|----|--|---|----|---|
| D | ANTH 102C [∞] (102HC [∞]), 103C(formerly 203C), 104C(begin F17), 106C, 208C(begin F17), 211C(begin F17), 225C(begin F17) COMM 220C [∞] (220HC [∞]) ECON 100C [∞] (100HC [∞]), 105C [∞] (105HC [∞]), 110C, 120C ETHS 101C [∞] (formerly 100C) (101HC [∞])(formerly 100HC), 129C [∞] , 130C [∞] , 131C [∞] , 150C [∞] (formerly 140C), 151C [∞] (formerly 141C), 152C [∞] , 160C [∞] , 170C [∞] , 171C [∞] , 235C(begin F17) GEOG 100C [∞] (100HC [∞]), 130C(begin F17), 160C HIST 110C [∞] (110HC [∞]), 111C [∞] (111HC [∞]), 112C [∞] (112HC [∞]), 113C [∞] (113HC [∞]), 135C, 142C(begin F05), 143C, 151C(begin F15), 152C(begin F15), 160C, 161C, 163C(begin F05), 165C, 170C [∞] (170HC [∞]), 171C [∞] (171HC [∞]), 190C(formerly 162AC), 191C(formerly 162BC), 270C(begin F05) HS 277C [∞] HUSR 200C(begin F17), 250C [∞] (begin F06), 255C [∞] (begin F06) KIN 249C(begin F17, formerly PE 250C), 280C(begin F17), 281C(begin F17), 283C (begin F17), 285C(begin F17) MGT 161C, 266C POSC 100C [∞] (100HC [∞]), 101C, 120C, 200C, 210C, 215C, 216C, 230C PSY 101C [∞] (101HC [∞]), 120C [∞] (begin F08), 139C(begin F17), 145C, <u>240C</u> (begin F05), 251C, 255C [∞] (begin F06) SOC 101C [∞] (101HC [∞]), 102C, <u>120C</u> (begin F08), 250C [∞] (begin F06), 275C, 277C(begin F15) | | | | | |
| CATEGORY E. PHYSICAL ACTIVITY AND HEALTH 1-UNIT MINIMUM | | | | | | |
| E | DANC 205C(begin F17) HRC 100C KIN 100C thru 222C, <u>234C</u> (now KIN 284 C), 244C, 270C (begin F17), 280C(begin F17), 281C(begin F17), 283C(begin F17), 284C (formerly PE 234 C), 285C(begin F17) | | | | | |
| Cypress College Graduation Requirements | | | | | | |
| CULTURAL DIVERSITY 3-UNIT MINIMUM | | | | | | |
| | AJ 160C(begin F17) ANTH 121C ATC 182C COMM 120C COUN <u>152C</u> DANC 101C ENGL 208C, 239C, 247C, 255C, 256C; ETHS 101C [∞] (formerly 100C) (101HC [∞])(formerly 100HC), 129C, 130C, 131C, 150C, 151C, 152C, 153C, 160C, 170C, 171C, 235C HIST 275C HS 277C HUSR 295C KIN 249C(formerly PE 250C), 281C(begin F17) MKT 205C MUS 113C(begin F05) POSC 209C PSY 131C(formerly 237C) REC 102C(begin F17) SOC <u>237C</u> THEA 107C [∞] (107HC [∞]) Completion of the Nursing Program also meets the Cultural Diversity graduation requirement. | | | | | |
| READING PROFICIENCY One of the following: | | | | | | |
| | ENGL 096C, 102C, 102HC, 103C(begin F14), 103HC(begin F16), 104C(begin F14), 104HC(begin F14), 106C Other ways to meet the requirement include: A satisfactory score on the Cypress College Reading Proficiency Test; Completion of CSU GE Certification, IGETC Certification, or a Bachelor Degree from a U.S. regionally accredited institution. Specific External Exam Credit such as Advanced Placement (AP) may satisfy the requirement. See a counselor for details. | | | | | |
| LEGEND | | | | | | |
| * | The Mathematics requirement can also be met by passing a Mathematics Proficiency Examination. Refer to the schedule of classes for time and date of administration of the examination. | | | | | |
| ** | Also meets Reading Proficiency requirement for graduation. | | | | | |
| ∞ | Also meets Cultural Diversity requirement for graduation. | | | | | |
| ◇ | Course may be used to satisfy requirements for one area only. | | | | | |
| □ | Duplicate credit not granted for the same cross listed courses, nor for non-honors and honors classes. | | | | | |
| NOTE: Underlining indicates a course is no longer offered at Cypress College. In order to receive General Education credit, the course must be on the official approved list at the time the course is taken. Please see a counselor to determine your catalog rights and the applicability of courses completed. | | | | | | |

To view the current Cypress College Native GE course list on-line, go to the Transfer Center website at: www.cypresscollege.edu/services/transfer/generalEducationPlans.

Please confer with a counselor for more information and to discuss your major requirements (Revised: 5/2017JH)

Associate Degree Graduation Requirements for Cypress College

NOTE: The following graduation requirements apply to all degrees with the exception of the Associate Degrees for Transfer (ADT) for priority admission to CSU. The list of available ADT degrees also known as Associate in Arts (AA-T) degrees or Associate in Science (AS-T) degrees are listed both in the catalog and on the Transfer Center website: <http://www.CypressCollege.edu/services/transfer>.

Cultural Diversity

As an educational community, Cypress College embraces the shared characteristics as well as the diverse intellectual viewpoints and ideas of its culturally rich population. To prepare students for effective participation in our society, selected academic courses are designed to: 1) foster respect for diverse populations; 2) assist students in understanding and critically evaluating personal biases; and 3) encourage students to apply the knowledge gained in these courses in their daily lives. To achieve this educational goal, Cypress College will require all students to take at least one course whose emphasis is on the United States and focuses specifically on issues such as race, gender, religion, national origin, sexual orientation, socio-economic background, physical and/or mental ability, and how they impact the struggles of people to achieve civil and human rights.

Please reference the list of approved Cultural Diversity courses for the college on the general education Native GE requirements list. Students may earn credit for course work previously completed at other regionally accredited institutions to meet this requirement upon review of the course by Admissions and Records to determine appropriateness of content to meet this local requirement.

Reading Proficiency

Proficiency in reading may be satisfied by completing one of the following:

- ENGL 096 C College Reading Strategies
- ENGL 102 C Introduction to Literature
- ENGL 102HC Honors Introduction to Literature
- ENGL 103 C Critical Reasoning and Writing
- ENGL 103HC Honors Critical Reasoning and Writing
- ENGL 104 C Critical Analysis and Literature
- ENGL 104HC Honors Critical Analysis and Literature
- ENGL 106 C Critical Reading, Writing and Thinking
- A satisfactory score on the Cypress College reading proficiency test. (Contact the Assessment Center at (714) 484-7000 ext. 48571 for information regarding the Reading Proficiency Exam.) **A student may attempt to pass the proficiency exam only one time after completion of English 100 C or equivalent.**

- California State University (CSU) general education certification.
- IGETC certification.
- Bachelor's degree from a regionally accredited institution.
- Passing score of 3 or higher on the Advanced Placement (AP) English Literature exam.

TRANSFER PROGRAMS

Transfer programs include course work in an academic area, general education requirements, and elective work for transfer to a four year baccalaureate institution. Transfer programs are designed to parallel the courses offered for freshmen and sophomores at other colleges and universities. In most cases, baccalaureate institutions prefer community college students to complete the lower division general education requirements and at least 60 transferable semester/quarter units. Generally, no more than 70 semester units earned at California community colleges will be applied toward a baccalaureate degree. Visit the Transfer Center website at <http://www.CypressCollege.edu/services/transfer>.

HOW TO TRANSFER TO A FOUR-YEAR COLLEGE

Each college or university has its own admission standards and curriculum requirements. Students should decide as soon as possible on the transfer school in order to identify the courses that must be completed and the grades that must be achieved prior to transfer. In general, students who attend Cypress College may transfer to a four-year college or university without loss of time or credits if, while in attendance, they accomplish the following:

- Satisfy the lower-division general education requirements prescribed by the transfer institution.
- Fulfill the lower-division major requirements prescribed by the transfer institution.
- Remove any subject or grade deficiencies incurred in high school, if required by the transfer institution for admission.
- Complete a minimum of 60 and a maximum of 70 transferable units.
- Maintain the appropriate GPA required by the transfer institution.

Grades are the best indicator of success in academic work. A minimum grade of "C" average in all transfer courses is a requirement for transfer to most four-year colleges. Grades in the major should be significantly higher. Students should confer with a counselor for the specific requirements of the school of their choice. The following charts indicate the general education transfer requirements for those colleges and universities most frequently utilized by Cypress College students. These transfer agreements are subject to an ongoing review and revision by the transfer institutions. The transfer agreements listed on the following charts represent agreements at the time of publication. Students should contact a counselor or the transfer institution of their choice for current information.

Liberal Arts Degree with Area of Emphasis

The Liberal Arts degree with Area of Emphasis provides students with the opportunity to earn a degree within a broad liberal arts education, allowing them to understand the intellectual relationships between various disciplines in a broader Area of Emphasis. Earning an Associate Degree may or may not be the most effective path to fulfilling transfer requirements. The courses listed for each Area of Emphasis in the Cypress College catalog do not reflect major preparation requirements at any specific university, but some may be used to fulfill local university requirements. **Please consult with a counselor and the Transfer Center for information regarding selection of an appropriate general education pattern and pertinent classes, as well as your intended major at the specific colleges/universities of choice.**

NOTE: This degree is an Associate Degree designed for transfer students; however, it does not qualify as an Associate Degree for Transfer (ADT) for CSU priority admission consideration. Please see a counselor for more information on differences in degree options offered at Cypress College for transfer students.

Requirements for the Liberal Arts Degree with Area of Emphasis include:

- Completion of California State University General Education Breadth requirements (CSU GE Breadth) or the Intersegmental General Education Transfer Curriculum (IGETC).
- Completion of at least 18 units in an Area of Emphasis from those outlined below. (Note: Where appropriate, courses in the Area of Emphasis may also be counted for a GE area.)
- A 2.0 (C) overall GPA and a 2.0 (C) in all courses taken in the Area of Emphasis.
- **Fulfillment of all graduation requirements**, to include local requirements of a minimum of one (1) unit of coursework approved for Physical Activity and Health and three (3) units of coursework approved for Cultural Diversity **for a total of 60 transferable units.**

Note: Completion of this Area of Emphasis degree option automatically meets the Reading Proficiency requirement.





**Liberal Arts AA Degree with Area of Emphasis
Cypress College 2017-2018**

ARTS & HUMANITIES emphasis

Student's Name _____ ID # @ _____ Date: _____

Major _____ Transfer To _____ Counselor _____

The Liberal Arts degree with Area of Emphasis provides students with the opportunity to earn a degree within a broad liberal arts education, allowing them to understand the intellectual relationships between various disciplines in a broader Area of Emphasis. Earning an Associate Degree may or may not be the most effective path to fulfilling transfer requirements. The courses listed for each Area of Emphasis in the Cypress College catalog do not reflect major preparation requirements at any specific university, but some may be used to fulfill local university requirements. **Reminder: Students with catalog rights for 2012 or prior, meet with a Counselor to confirm if courses taken at that time are applicable to the Arts and Humanities emphasis and the Transfer Center for information regarding selection of an appropriate general education pattern and pertinent classes, as well as your intended major at the specific colleges/universities of choice.**

Requirements for the Liberal Arts Degree with Area of Emphasis include:

- Completion of California State University General Education Breadth requirements (CSU GE Breadth) or the Intersegmental General Education Transfer Curriculum (IGETC).
- Completion of at least 18 units in an Area of Emphasis from those outlined below. (Note: Where appropriate, courses in the Area of Emphasis may also be counted for a GE area).
- A 2.0 (C) overall GPA and a 2.0 (C) in all courses taken in the Area of Emphasis.
- **Effective Fall 2017 - Fulfillment of all graduation requirements, to include local requirements of a minimum of one (1) unit of coursework approved for Physical Activity and Health and three (3) units of coursework approved for Cultural Diversity for a total of 60 transferable units.**

Note: Completion of this Area of Emphasis degree option automatically meets the Reading Proficiency requirement.

Liberal Arts AA Degree: ARTS & HUMANITIES emphasis

The Arts & Humanities option under Liberal Arts is an ideal choice for students planning on transferring to the California State University (CSU) or University of California (UC). Students are able to satisfy both their transfer institution's general education requirements, plus focus on transfer major preparation course work required by the four-year university. The Area of Emphasis listed below includes courses that transfer to CSU and/or UC. Courses in **BOLD** are transferable to UC. Refer to www.ASSIST.org for further details.

This degree emphasizes the study of cultural, literary, humanistic activities and artistic expression of human beings. Students will evaluate and interpret the ways in which people through the ages in different cultures have responded to themselves and the world around them in artistic and cultural creation. Students will also learn to value aesthetic understanding and incorporate these concepts when constructing value judgments.

| (Check boxes accordingly) | Legend: C= Completed | IP=In Progress | R= Remaining | C | IP | R |
|--|----------------------|----------------|--------------|---|----|---|
| Select 18 or more units from at least 2 discipline areas: | | | | | | |
| ART 100C, 110C, 111C, 112C (112HC), 114C, 120C, 150C, 151C, 182C, 194C(Formerly 189C), 216C | | | | | | |
| ANTH 107C, | | | | | | |
| CHIN 101C, 102C, 203C | | | | | | |
| COMM 220C (220HC) | | | | | | |
| DANC 101C | | | | | | |
| ENGL 102C (102HC), 110C, 111C, 125C (125HC), 208C, 211C, 212C, 221C, 222C, 234C (234HC), 239C, 243C, 247C, 255C, 256C, 260C | | | | | | |
| ETHS 130C, 131C, 151C(Formerly 141C), 152C, 160C, 171C | | | | | | |
| FREN 101C, 102C, 200C, 203C, 204C | | | | | | |
| HIST 110C (110HC), 111C (111HC), 112C (112 HC), 113C (113HC), 160C, 161C, 163C, 165C, 275C | | | | | | |
| INDS 100C, 101C | | | | | | |
| JAPN 101C, 102C, 200C, 203C, 204C | | | | | | |
| MAD 196C | | | | | | |
| MUS 101C, 103C(Formerly 103AC), 113C, 116C, 117C, 118C (118HC), 119C, 120C, 127C | | | | | | |
| PHOT 101C | | | | | | |
| PHIL 100C (100HC), 101C, 110C, 120C, 135C, 160C, 201C, 202C, 230C, 240C(Formerly 225C) | | | | | | |
| PORT 101C, 102C | | | | | | |
| SPAN 101C, 102C, 200C, 201C, 202C, 203C, 204C | | | | | | |
| THEA 100C, 102C, 107C (107HC), 120C, 121C, 126C, 129C, 132C, 133C, 145C, 149C | | | | | | |

SPECIAL NOTE: This degree is an Associate Degree designed for transfer students; **however, it does not qualify as an Associate Degree for Transfer (ADT)** for CSU priority admission consideration. Please see a counselor for more information on differences in degree options offered at Cypress College for transfer students.

Revised: 6/15/17 JH



**Liberal Arts AA Degree with Area of Emphasis
Cypress College 2017-2018**

HUMAN COMMUNICATION emphasis

Student Name _____ ID@ _____ Date: _____

Major _____ Transfer To _____ Counselor _____

The Liberal Arts degree with Area of Emphasis provides students with the opportunity to earn a degree within a broad liberal arts education, allowing them to understand the intellectual relationships between various disciplines in a broader Area of Emphasis. Earning an Associate Degree may or may not be the most effective path to fulfilling transfer requirements. The courses listed for each Area of Emphasis in the Cypress College catalog do not reflect major preparation requirements at any specific university, but some may be used to fulfill local university requirements. **Reminder: Students with catalog rights for 2012 or prior, meet with a Counselor to confirm if courses taken at that time are applicable to the Human Communication emphasis and the Transfer Center for information regarding selection of an appropriate general education pattern and pertinent classes, as well as your intended major at the specific colleges/universities of choice.**

Requirements for the Liberal Arts Degree with Area of Emphasis include:

- Completion of California State University General Education Breadth requirements (CSU GE Breadth) or the Intersegmental General Education Transfer Curriculum (IGETC).
- Completion of at least 18 units in an Area of Emphasis from those outlined below. (Note: Where appropriate, courses in the Area of Emphasis may also be counted for a GE area).
- A 2.0 (C) overall GPA and a 2.0 (C) in all courses taken in the Area of Emphasis.
- **Effective Fall 2017 - Fulfillment of all graduation requirements, to include local requirements of a minimum of one (1) unit of coursework approved for Physical Activity and Health and three (3) units of coursework approved for Cultural Diversity for a total of 60 transferable units.**

Note: Completion of this Area of Emphasis degree option automatically meets the Reading Proficiency requirement.

Liberal Arts AA Degree: HUMAN COMMUNICATION emphasis

The Human Communication option under Liberal Arts is an ideal choice for students planning on transferring to the California State University (CSU) or University of California (UC). Students are able to satisfy both their transfer institution's general education requirements, plus focus on the transfer major preparation course work required by the four-year university. The Area of Emphasis listed below includes courses that transfer to CSU and/or UC. Courses in **BOLD** are transferable to UC. Refer to www.ASSIST.org for further details.

This degree emphasizes the content of communication as well as the form and should provide an understanding of the psychological basis and social significance of communication. Students will be able to assess communication as the process of human symbolic interaction. Students will also develop skills in the areas of reasoning and advocacy, organization, accuracy, reading and listening effectively. Students will be able to integrate important concepts of critical thinking as related to the development of analysis, critical evaluation, to reason inductively and deductively that will enable them to make important decisions regarding their own lives and society at large.

(Check boxes accordingly) Legend: C= Completed IP= In Progress R= Remaining

| | C | IP | R |
|--|---|----|---|
| Select 18 or more units from at least 2 discipline areas: | | | |
| COMM 100C (100HC), 135C, 138C, 238C | | | |
| ENGL 100C (100HC), 103C (103HC), 104C (104HC), 106C | | | |
| PHIL 170C, 172C, 175C | | | |

SPECIAL NOTE: This degree is an Associate Degree designed for transfer students; **however, it does not qualify as an Associate Degree for Transfer (ADT)** for CSU priority admission consideration. Please see a counselor for more information on differences in degree options offered at Cypress College for transfer students.



**Liberal Arts AA Degree with Area of Emphasis
Cypress College 2017-2018**

MATH & SCIENCE emphasis

Student's Name _____ ID@ _____ Date: _____

Major _____ Transfer To _____ Counselor _____

The Liberal Arts degree with Area of Emphasis provides students with the opportunity to earn a degree within a broad liberal arts education, allowing them to understand the intellectual relationships between various disciplines in a broader Area of Emphasis. Earning an Associate Degree may or may not be the most effective path to fulfilling transfer requirements. The courses listed for each Area of Emphasis in the Cypress College catalog do not reflect major preparation requirements at any specific university, but some may be used to fulfill local university requirements. **Reminder: Students with catalog rights for 2012 or prior, meet with a Counselor to confirm if courses taken at that time are applicable to the Math & Science emphasis and the Transfer Center for information regarding selection of an appropriate general education pattern and pertinent classes, as well as your intended major at the specific colleges/universities of choice.**

Requirements for the Liberal Arts Degree with Area of Emphasis include:

- Completion of California State University General Education Breadth requirements (CSU GE Breadth) or the Intersegmental General Education Transfer Curriculum (IGETC).
- Completion of at least 18 units in an Area of Emphasis from those outlined below. (Note: Where appropriate, courses in the Area of Emphasis may also be counted for a GE area).
- A 2.0 (C) overall GPA and a 2.0 (C) in all courses taken in the Area of Emphasis.
- **Effective Fall 2017 - Fulfillment of all graduation requirements, to include local requirements of a minimum of one (1) unit of coursework approved for Physical Activity and Health and three (3) units of coursework approved for Cultural Diversity for a total of 60 transferable units.**

Note: Completion of this Area of Emphasis degree option automatically meets the Reading Proficiency requirement.

Liberal Arts AA Degree: MATH & SCIENCE emphasis

The Math & Science option under Liberal Arts is an ideal choice for students planning on transferring to the California State University (CSU) or University of California (UC). Students are able to satisfy both their transfer institution's general education requirements, plus focus on transfer major preparation course work required by the four-year university. The Area of Emphasis listed below includes courses that transfer to CSU and/or UC. Courses in **BOLD** are transferable to UC. Refer to www.ASSIST.org for further details.

This degree emphasizes the natural sciences which examine the physical universe, its life forms, and its natural phenomena. Courses in Math emphasize the development of mathematical and quantitative reasoning skills beyond the level of intermediate algebra. Students will be able to demonstrate an understanding of the methodologies of science as investigative tools. Students will also examine the influence that the acquisition of scientific knowledge has on the development of the world's civilization. Students will also examine the influence that the acquisition of scientific knowledge has on the developmental of the world's civilizations.

(Check boxes accordingly) Legend: C= Completed IP= In Progress R= Remaining

SELECT 18 OR MORE UNITS FROM AT LEAST 2 DISCIPLINE AREAS:

| | C | IP | R |
|--|---|----|---|
| ANTH 101C (101HC), 101LC, 210C | | | |
| ASTR 116C (116HC), 117C (117HC) | | | |
| BIOL 101C (101HC), 102C, 103C, 122C, 174C, 175C, 210C, 231C, 241C, 276C, 277C, 278C | | | |
| CHEM 100C, 101C, 103C, 104C, 107C, 111AC, 111BC, 201C | | | |
| GEOG 102C, 102LC, 140C | | | |
| GEOL 100C (100HC), 101C, 103C, 105C, 115C, 120C, 125C, 130C, 131C, 190C | | | |
| MATH 100C, 110C, 115C, 120C, 130C, 141C, 142C, 150AC, 150BC, 250AC, 250BC | | | |
| PHSC 104C | | | |
| PHYS 130C, 201C, 202C, 210C, 211C, 221C, 222C, 223C | | | |
| PSY 161C (161HC) | | | |
| SOC 161C (161HC) | | | |

SPECIAL NOTE: This degree is an Associate Degree designed for transfer students; **however, it does not qualify as an Associate Degree for Transfer (ADT)** for CSU priority admission consideration. Please see a counselor for more information on differences in degree options offered at Cypress College for transfer students.



**Liberal Arts AA Degree with Area of Emphasis
Cypress College 2017-2018**

SOCIAL & BEHAVIORAL SCIENCES emphasis

Student's Name _____ ID@ _____ Date: _____

Major _____ Transfer To _____ Counselor _____

The Liberal Arts degree with Area of Emphasis provides students with the opportunity to earn a degree within a broad liberal arts education, allowing them to understand the intellectual relationships between various disciplines in a broader Area of Emphasis. Earning an Associate Degree may or may not be the most effective path to fulfilling transfer requirements. The courses listed for each Area of Emphasis in the Cypress College catalog do not reflect major preparation requirements at any specific university, but some may be used to fulfill local university requirements. **Reminder: Students with catalog rights for 2012 or prior, meet with a Counselor to confirm if courses taken at that time are applicable to the Social & Behavioral emphasis and the Transfer Center for information regarding selection of an appropriate general education pattern and pertinent classes, as well as your intended major at the specific colleges/universities of choice.**

Requirements for the Liberal Arts Degree with Area of Emphasis include:

- Completion of California State University General Education Breadth requirements (CSU GE Breadth) or the Intersegmental General Education Transfer Curriculum (IGETC).
- Completion of at least 18 units in an Area of Emphasis from those outlined below. (Note: Where appropriate, courses in the Area of Emphasis may also be counted for a GE area).
- A 2.0 (C) overall GPA and a 2.0 (C) in all courses taken in the Area of Emphasis.
- **Effective Fall 2017 - Fulfillment of all graduation requirements, to include local requirements of a minimum of one (1) unit of coursework approved for Physical Activity and Health and three (3) units of coursework approved for Cultural Diversity for a total of 60 transferable units.**

Note: Completion of this Area of Emphasis degree option automatically meets the Reading Proficiency requirement.

Liberal Arts AA Degree: SOCIAL & BEHAVIORAL SCIENCES emphasis

The Social & Behavioral Sciences option under Liberal Arts is an ideal choice for students planning on transferring to the California State University (CSU) or University of California (UC). Students are able to satisfy both their transfer major preparation course work. The Area of Emphasis listed below includes courses that transfer to CSU and/or UC. Courses in **BOLD** are transferable to UC. Refer to www.ASSIST.org for further details.

This degree emphasizes the perspective, concepts, theories and methodologies of the disciplines typically found in the vast variety of disciplines that comprise study in the Social and Behavioral Sciences. Students will study about themselves and others as members of a larger society. Topics and discussion to stimulate critical thinking about ways people have acted in response to their societies will allow students to evaluate how societies and social subgroups operate.

| (Check boxes accordingly) Legend: C= Completed IP= In Progress R= Remaining | C | IP | R |
|--|---|----|---|
| SELECT 18 OR MORE UNITS FROM AT LEAST 2 DISCIPLINE AREAS: | | | |
| ANTH 102C (102HC), 103C(Formerly 203C), 104C, 105C, 106C, 107C, 121C, 225C | | | |
| COMM 120C | | | |
| ECON 100C (100HC), 105C (105HC), 110C, 120C, 260C | | | |
| ETHS 101C(Formerly 100C) (101HC)(Formerly 100HC), 129C, 130C, 131C, 150C(Formerly 140C), 151C(Formerly 141C), 152C, 153C, 160C, 170C, 171C, 235C | | | |
| GEOG 100C (100HC), 130C, 160C, 260C | | | |
| HS 277C | | | |
| HIST 110C (110HC), 111C (111HC), 112C (112HC), 113C (113HC), 135C, 142C, 143C, 151C, 152C, 160C, 161C, 163C, 165C, 170C (170HC), 171C (171HC), 190C(Formerly 162AC), 191C(Formerly 162BC), 270C, 275C | | | |
| HUSR 200C, 250C, 255C, 292C | | | |
| JOUR 110C, 118C | | | |
| KIN 249C, 281C, 285C | | | |
| MGT 161C | | | |
| POSC 100C (100HC), 101C, 120C, 200C, 209C, 210C, 215C, 216C, 230C | | | |
| PSY 101C (101HC), 110C, 120C, 131C(Formerly 237C), 139C, 145C, 202C, 221C, 222C, 251C, 255C | | | |
| SOC 101C (101HC), 102C, 225C, 250C, 275C, 277C, 292C | | | |

SPECIAL NOTE: This degree is an Associate Degree designed for transfer students; **however, it does not qualify as an Associate Degree for Transfer (ADT)** for CSU priority admission consideration. Please see a counselor for more information on differences in degree options offered at Cypress College for transfer students. Revised:6/15/17 JH

Liberal Arts Degree with a Specified Department/Area Major

The Liberal Arts degree with Departmental/Area Major provides students with the opportunity to earn a degree within a broad liberal arts education, allowing them to understand the intellectual relationships between various disciplines with a more specific focus in a Departmental/Area Major. Earning an Associate Degree may or may not be the most effective path to fulfilling transfer requirements. The courses listed for each Departmental/Area Major in the Cypress College catalog do not reflect major preparation requirements at any specific university, but some may be used to fulfill local university requirements. Students pursuing more than one specified departmental major may double count a maximum of 7 units to fulfill major requirements. **Please consult with a counselor and the Transfer Center for information regarding selection of an appropriate general education pattern and pertinent classes, as well as your intended major at the specific colleges/universities of choice.**

NOTE: This degree is an Associate Degree designed for transfer students; however, it does not qualify as an Associate Degree for Transfer (ADT) for CSU priority admission consideration. Please see a counselor for more information on differences in degree options offered at Cypress College for transfer students.

Requirements for the Liberal Arts Degree with a Specified Departmental/Area Major include:

- Completion of the California State University General Education Breadth requirements (CSU GE Breadth) or the Intersegmental General Education Transfer Curriculum (IGETC);
- Completion of at least 18 units in one Departmental/Area Major from those outlined below. (Note: Where appropriate, courses in the Departmental/Area Major may also be counted for a GE area.) At least 50% of all major course work must be completed at Cypress College;
- A 2.0 (C) overall GPA and a 2.0 (C) in all courses taken in the Departmental/Area Major;
- Fulfillment of all graduation requirements, to include local requirements of a minimum of one (1) unit of coursework approved for Physical Activity and Health and three (3) units of coursework approved for Cultural Diversity for a total of 60 transferable units.

Note: Completion of this option automatically meets the Reading Proficiency requirement.

This degree includes only transfer-level course work; however, students who select a Departmental/Area Major, and intend to earn a Bachelor's Degree should consult with a counselor to ensure optimal application of credit toward the Bachelor's Degree requirements. Completion of major preparation requirements as determined by the receiving UC or CSU campus are officially listed on the Assist website at www.assist.org.

NOTE: Specific course requirements for Departmental/Area Majors are listed in applicable sections of the catalog.

Departmental/Area Majors Offered by Cypress College are:

African American Studies (see Ethnic Studies)
 Anthropology
 Business
 Chicana/o Studies (see Ethnic Studies)
 Ethnic Studies
 Geography
 Philosophy

Associate Degrees for Transfer (Associate in Arts/Associate in Science Degree for Transfer) (ADT)

California Community Colleges are now offering associate degrees for transfer (ADT) to the CSU. These may include Associate in Arts (AA-T) or Associate in Science (AS-T) degrees. These degrees are designed to provide a clear pathway to a CSU major and baccalaureate degree. California Community College students who are awarded an ADT degree are guaranteed admission with junior standing somewhere in the CSU system and given priority admission consideration to their local CSU campus or to a program that is deemed similar to their community college major. This priority does not guarantee admission to specific majors or campuses.

The ADT degree is intended for students who plan to complete a bachelor's degree in a similar major at a CSU campus. Students who have been awarded an ADT are able to complete their remaining requirements for the 120-unit baccalaureate degree within 60 semester or 90 quarter units (unless the major is designated "high-unit" major). To view the most current list of Cypress College Associate Degrees for Transfer and to find out which CSU campuses accept each degree, please go to www.CypressCollege.edu/services/transfer. This degree may not be the best option for students intending to transfer to a particular CSU campus or to a university or college that is not part of the CSU system.

Current and prospective community college students are encouraged to meet with a counselor to review their options and learn how to develop an educational plan that best meets their goals and needs as it relates to university admission and transfer requirements.

Requirements for the Associate Degree for Transfer (ADT) include:

- Completion of the California State University General Education Breadth requirements (CSU GE Breadth) or the Intersegmental General Education Transfer Curriculum (IGETC).
- Completion of at least 18 semester units or 27 quarter units in one AA-T or AS-T Major from those outlined following. (Note: Where appropriate, courses in the AA-T or AS-T Major may also be counted for a GE area.)
- A 2.0 (C) overall GPA and a 2.0 (C) in all courses taken in the AA-T or AS-T Major.
- Completion of a minimum of 60 units of CSU transferable course work.

This degree includes only transfer-level course work; however, students who select an AA-T or AS-T and intend to earn a Bachelor's Degree should consult with a counselor to ensure optimal application of credit toward the Bachelor's Degree requirements. Completion of major preparation requirements as determined by the receiving UC or CSU campus are officially listed on the Assist website at www.assist.org.

NOTE: Specific course requirements for the AA-T and AS-T Majors are listed in applicable sections of the catalog. The approved curriculum may also be accessed on the Articulation page of the Transfer Center site at: www.CypressCollege.edu/services/transfer/adt.aspx.

AA-T or AS-T Majors Offered by Cypress College for 2017–2018 are as follows

(Note: Additional ADTs are currently in development):

Anthropology
 Art History
 Business Administration
 Chemistry
 Communication Studies
 Elementary Teacher Education
 English
 Geography
 Geology
 History
 Kinesiology
 Mathematics
 Music
 Philosophy
 Physics
 Political Science
 Psychology
 Sociology
 Studio Arts
 Theater Arts

CSU GENERAL EDUCATION BREADTH REQUIREMENTS

Students wishing to transfer to California State Universities should follow this plan.

Requirements for graduation from the California State University System include completion of specific courses in general education. Cypress College is permitted to certify that a student has satisfied the lower division 39-unit general education requirements established by the California State University System.

Under the provisions of Title 5 and Executive Order 1065, regionally accredited colleges and universities may certify one or more subject areas for students being admitted to the CSU system, a.k.a. partial certification. Students admitted to a CSU campus with subject area or partial certification should not be held to completing additional courses for the areas already certified.

In order to be partially certified, Cypress College students must complete all the CSU lower-division General Education Breadth Requirements in a specific area. Students who have completed courses at other regionally accredited colleges and universities may “pass along” those courses for either partial or full certification at Cypress College. To meet general education requirements and obtain full certification, students must complete the pattern of courses in the five categories listed.

Students should apply for certification during or after the semester in which they are completing General Education Breadth Requirements. Students are advised to request certification prior to enrolling at the university due to varying CSU campus partial certification policies that may prohibit the certification from being granted.

CSU Certification policy specifies that a course or sequence of courses used to satisfy a requirement in one area, may not be used to satisfy a requirement in another area. Students should talk to a counselor for more information. Some state universities will also not allow students to count courses in their major field as part of general education requirements.

Courses on this list are approved by the CSU Chancellor’s Office for a specific academic year; that is, a course must be on the list when the course is taken in order to be certified. Check with a counselor and review the catalog of the individual state university for further clarification.

A pass along form must be completed by a Cypress College counselor when courses are being used from other non-certifying colleges and universities and submitted with the application for CSU General Education Certification. No deadlines apply for the CSU GE Breadth pattern.

The courses on the following CSU GE Breadth Requirements page are approved at the time of printing. Check with a counselor or www.assist.org for the most recent list of approved courses.

NOTE: Independent universities or out of state universities may accept the CSU GE pattern. Check with the individual university and your counselor to verify.

CSU GE BREADTH FOR STEM MAJORS

Per CSU Executive Order 1100, students pursuing certain Associate Degrees for Transfer may be eligible to take GE Breadth for STEM, deferring two lower-division GE courses until after transfer. GE Breadth for STEM is applicable only to majors in which the Transfer Model Curriculum explicitly indicates the availability of the option. **Note: As of Fall 2016, only the Biology ADT and Chemistry ADT (active Fall 2016) have this option.**

California Colleges preparing a “CSU GE Breadth for STEM” certification as part of an Associate Degree for Transfer should ensure that the student has completed:

- a. All courses in Areas A, B, and E of the traditional GE Breadth curriculum; and
- b. One course in Area C1 Arts and one course in Area C2 Humanities; and
- c. Two courses in Area D from two different disciplines

Therefore, a student can defer completion of one course in Area C and one in Area D for after transfer. See a counselor for details.

CSU GE Breadth Certificate of Achievement

To find out more about transfer certificates see Certificate of Achievement program information located under Programs of Study in this catalog.



CALIFORNIA STATE UNIVERSITY GENERAL EDUCATION BREADTH REQUIREMENTS
39 Units Required

Student's Name: _____ ID#: @ _____ Date: _____

Major: _____ Transfer To: _____ Counselor: _____

Certification of General Education Requirements for CSU: Students planning to graduate from one of the campuses of the California State University must complete a minimum of 48 semester units in General Education breadth courses. Cypress College is permitted to certify completion of the lower division 39-unit general education requirement (a minimum of 9 units of General Education coursework must be completed at the upper division level after transfer). To meet general education requirements and obtain certification, students must complete the pattern of courses in the categories listed. Please see the current catalog for additional information on CSU-GE Partial Certification.) Certification is not automatic. Students must apply for GE certification or be pursuing the CSU GE Certificate of Achievement through the Admissions and Records Office by the published deadline during the semester in which requirements will be completed or thereafter. The course must be on the list when it is taken in order to be certified. Students should refer to the legend below or the Cypress College CSU GE-Breadth Certification List on www.assist.org to verify that a course was valid when it was taken. **A course or sequence of courses used to satisfy a requirement in one area may not be used to satisfy a requirement in another area.** Some universities will not allow students to count courses in their major field as part of general education. Check with a counselor and review the university catalog for further clarification.

(Check boxes accordingly) LEGEND: C=Completed IP=In Progress R=Remaining

| | A. ENGLISH LANGUAGE COMMUNICATION AND CRITICAL THINKING Requirement: Must include a minimum of 3-units from each area. All courses in this category must be completed with a grade of "C" or better. | 9 Unit Minimum | AP CREDIT or OTHER COLLEGE COURSE(S) | C | IP | R |
|--------------|---|-----------------------|---|----------|-----------|----------|
| A1 | Oral Communication: COMM 100C ² (100HC ²) | | | | | |
| A2 | Written Communication: ENGL 100C ² (100HC ²) | | | | | |
| A3 | Critical Thinking: COMM 135C, 138C, 238C ENGL 103C ² , (103HC ²), 104C ² (104HC ²), 106C PHIL 170C, 172C, 175C | | | | | |
| | B. SCIENTIFIC INQUIRY AND QUANTITATIVE REASONING Requirement: Must include one course from Physical Science AND one course from Life Science AND one course from Mathematics. One of the science courses must include a corresponding laboratory experience. | 9 Unit Minimum | | | | |
| B1/B3 | Physical Science w/ Lab: ASTR 116C ² /117C ² (116HC ² /117HC ²) CHEM 100C, 101C, 104C, 107C, 111AC, 111BC, 201C(begin F13) GEOG 102C/102LC GEOL 100C ² /101C (100HC ²)/101C, 100C ² /115C (100HC ²)/115C, 103C, 105C, 130C/131C PHSC 104C PHYS 130C, 201C, 202C, 210C, 211C, 221C, 222C, 223C | | | | | |
| B2/B3 | Life Sciences w/ Lab: ANTH 101C ² (101HC ²), 101LC BIOL 101C ² (101HC ²), 111C/112C, 113C/114C, 122C, 174C, 175C, 210C, 230C, 231C(begin S06), 241C(begin S06), 276C(begin F15) | | | | | |
| B1 | Physical Sciences w/o Lab: ASTR 116C ² (116HC ²) CHEM 103C GEOG 102C, 140C(begin F13) GEOL 100C ² (100HC ²), 120C, 125C, 130C, 190C | | | | | |
| B2 | Life Science w/o Lab: ANTH 101C ² (101HC ²), 210C (begin F16) BIOL 102C, 103C, 277C(begin F15), 278C(begin F15) | | | | | |
| *B4 | Mathematics and Quantitative Reasoning (grade of "C" or better required): CSCI 205C MATH 100C, 110C, 115C, 120C ² , 130C, 141C, 142C, 150AC, 150BC, 250AC, 250BC PSY 161C ² (161HC ²) SOC 161C ² (161HC ²) | | | | | |
| | C. ARTS AND HUMANITIES Requirement: Must include at least one course in the Arts AND one course in the Humanities. | 9 Unit Minimum | AP CREDIT or OTHER COLLEGE COURSE(S) | C | IP | R |
| C1 | Arts (Art, Dance, Music and Theater): ART 100C, 110C, 111C, 112C ² (112HC ²), 114C, 120C, 150C, 151C, 182C, 194C(formerly 189C), 216C(begin F10) DANC 101C ² , 105C(end SU12), 106C(end SU12), 107C(end SU12), 108C(end SU12), 109C(end SU12), 111C(end SU12), 112C(end SU12), 120C ENGL 125C ² (begin F99) 125HC ² MAD 196C(begin F15) MUS 101C, 103C(formerly 103AC), 113C ² , 116C, 117C, 118C ² (118HC ²), 119C(begin F01), 120C, 122C(end SU12), 126C(end SU12), 127C, 130C(end SU12), 135C(end SU12), 143C(end SU12), 146C(end SU12), 282C(end SU12), 291C; PHOT 101C THEA 100C, 102C(F95-F10;begin F13), 107C ² (107HC ²), 120C, 121C, 126C, 129C, 132C, 133C, 145C, 149C | | | | | |

(Check boxes accordingly) LEGEND: C=Completed IP=In Progress R=Remaining

| | | AP CREDIT or OTHER COLLEGE COURSE(S) | C | IP | R |
|-----------|---|---|---|----|---|
| C2 | Humanities (Literature, Philosophy, Foreign Languages): ANTH 107C◊ CHIN 101C, 102C, 203C COMM 220C [∞] (220HC [∞]) ENGL 102C [∞] (102HC [∞]), 110C [∞] , 111C [∞] , 125C [∞] (F99 - F00 only) 125HC [∞] (F99 - F00 only), 208C [∞] , 211C, 212C, 221C, 222C, 234C [∞] (234HC [∞]), 239C [∞] , 243C, 247C [∞] , 255C [∞] , 256C [∞] , 260C ETHS 130C◊ [∞] (begin F03), 131C◊ [∞] (formerly 141C), 152C◊ [∞] , 160C◊ [∞] , 171C◊ [∞] FREN 101C, 102C, 200C, 203C, 204C HIST 110C◊ [∞] (110HC◊ [∞]), 111C◊ [∞] (111HC◊ [∞]), 112C◊ [∞] (112HC◊ [∞])(begin F04), 113C◊ [∞] (113HC◊ [∞]), 160C◊, 161C◊, 163C◊, 165C◊, 275C◊ [∞] (begin S05) INDS 100C [∞] , 101C◊ [∞] JAPN 101C, 102C, 125C, 200C, 203C, 204C PHIL 100C [∞] (100HC [∞]), 101C, 110C, 120C, 135C, 160C, 165C, 201C(begin S05), 202C, 230C, 240C(begin S06)(formerly 225C) PORT 101C, 102C(begin S06) SPAN 101C [∞] (101HC [∞]), 102C [∞] (102HC [∞]), 200C, 201C, 202C, 203C, 204C | | | | |
| | D. SOCIAL SCIENCES 9 Unit Minimum Requirement: Must take courses in at least two different disciplines. Students strongly encouraged to take classes that double-count for CSU graduation requirements; one from Group A and one from Group B below. | | | | |
| D | Note: Students may fulfill Area D by choosing one course from the courses listed below, one course from Group A and one course from Group B. ANTH 102C [∞] (102HC [∞]), 103C◊(formerly 203C), 104C, 105C, 106C, 107C◊, 121C [∞] , 225C COMM 120C [∞] ECON 100C [∞] (100HC [∞]), 105C [∞] (105HC [∞]), 110C, 120C(begin F15), 260C◊ [∞] ETHS 101C◊ [∞] (formerly 100C) (101HC◊ [∞])(formerly 100HC), 129C [∞] , 130C◊ [∞] (begin F03), 131C◊ [∞] , 150C [∞] (formerly 140C), 151C◊ [∞] (formerly 141C), 152C◊ [∞] , 153C [∞] , 160C◊ [∞] , 170C [∞] , 171C◊ [∞] , 235C [∞] GEOG 100C [∞] (100HC [∞]), 130C, 140C(end SU14), 160C, 260C◊ [∞] HIST 110C◊ [∞] (110HC◊ [∞]), 111C◊ [∞] (111HC◊ [∞]), 112C◊ [∞] (112HC◊ [∞]), 113C◊ [∞] (113HC◊ [∞]), 135C, 142C, 143C, 151C, 152C, 160C◊, 161C◊, 163C◊, 165C◊, 170C [∞] (170HC [∞]), 171C [∞] (171HC [∞]), 190C [∞] (formerly 162AC), 191C [∞] (formerly 162BC), 270C◊(begin F04), 275C◊ [∞] HS 277C [∞] HUSR 200C, 250C◊ [∞] (begin S06), 255C◊ [∞] (begin S06), 292C(begin S06) JOUR 110C, 118C KIN 249 C (formerly PE 250, begin F16), 281C(begin F17), 285C(begin F17) MGT 161C POSC 100C [∞] (100HC [∞]), 101C [∞] , 120C, 130C, 200C, 209C [∞] , 210C, 215C, 216C, 230C PSY 101C [∞] (101HC [∞]), 110C, 131C [∞] (begin F13)(formerly 237C), 139C, 145C◊(begin S06), 202C(begin F02), 221C(begin F02), 222C, 240C◊, 251C, 255C◊ [∞] (begin S06) SOC 101C [∞] (101HC [∞]), 102C(begin F02), 225C◊, 237C [∞] , 250C◊ [∞] (begin S06), 275C, 277C, 292C(begin S06) | | | | |
| | CSU Graduation Requirement in U.S History, Constitution, & American Ideals: Note: Double-counting is allowed for these courses in the two groups below (with only one G.E. category). Group A (U.S. Constitution & Government): POSC 100C [∞] (100HC [∞]), 101C Group B (U.S. History): ETHS 101C [∞] (begin F04)(formerly 100C) (101HC [∞])(formerly 100HC), 130C [∞] , 131C [∞] , 152C [∞] (begin F16) 160C [∞] (begin S07) HIST 170C [∞] (170HC [∞]), 171C [∞] (171HC [∞]), 190C(formerly 162AC), 191C(formerly 162BC) | | | | |
| | E. LIFELONG UNDERSTANDING AND SELF-DEVELOPMENT 3 Unit Minimum Note: Some courses below are 1 unit classes and multiples courses may need to be taken to fulfill the area minimum. | | | | |
| E | Integrated Organism: CIS 111C COMM 105C COUN 105C, 141C, 144C, 145C, 146C, 150C, 151C DANC 100C (limit 1 unit, counted as activity below), 132C HRC 100C(begin F03) HUSR 250C◊ [∞] (begin S06), 255C◊ [∞] (begin S06) KIN 270C, 281C, 283C, 285C (begin F17) PE 231C, 234C, 235C, 237C, 242C, 244C PSY 120C [∞] , 145C◊(begin S06), 240C◊, 255C◊ [∞] (begin S06) SOC 120C [∞] , 250C◊ [∞] (begin S06) | Activity: ALL KINESIOLOGY AND DANCE ACTIVITY CLASSES KIN 100C-222C AND DANC 100C, 105C-112C(begin F11), 113C-117C(begin F15), 130C(begin F15), 132C(begin F13), 136C(begin F15), 137C(begin F15), 139C, 205C(begin F15) Only one (1) unit of physical activity may count toward fulfillment of this requirement. | | | |
| | LEGEND * Note: Certain majors require specific Mathematics course(s). See a Counselor for details. ◊ Course may be used to satisfy requirements for one area only. ∞ The class also may be used to satisfy the Cypress College Associates Degree Cultural Diversity requirement. □ Duplicate credit not granted for the same cross-listed courses nor for non-honors and honors classes. ^ See CSU graduation requirement in U.S. History, Constitution, and American Ideals. | | | | |
| | NOTE: Underlining indicates a course is no longer offered at Cypress College. Students may still receive credit, as long as a course was on the official approved list in that category at the time it was taken. The notations reflected after classes represent either the time a class was approved or ended, or that the class is pending approval. | | | | |

Please check the CSU-GE Breadth Certification list on www.assist.org and confer with a counselor for more information and to discuss your major requirements. See the Cypress College Catalog for information on how to receive a CSU GE Certificate of Achievement upon completion of this pattern.

INTERSEGMENTAL GENERAL EDUCATION TRANSFER CURRICULUM (IGETC)

The Intersegmental General Education Transfer Curriculum (IGETC) is a general education program which community college transfer students may use to fulfill lower division general education requirements for the California State University (CSU) or University of California (UC) system. Completion of IGETC eliminates the need to take additional lower division general education courses after transfer. Students approaching readiness for transfer who are unable to complete one or two IGETC courses that are not required for admission to the university may request to complete IGETC after transferring.

See a counselor for more information.

IGETC is accepted by the University of California, California State University, and by many private institutions. Students wishing to transfer to the University of California or who are undecided about their transfer institution should consult a counselor before choosing this plan.

Students must apply for IGETC certification (full or partial) in the Admissions and Records Office. **Courses will be certified ONLY if they are on the official IGETC list during the catalog year they are taken.**

In addition to the course requirements for each subject area, full certification for the CSU must include completion of the Oral Communications requirement. With the UC, Oral Communications is NOT required, but the certification must include satisfactory completion of the Language Other Than English proficiency requirements. A course or sequence used to satisfy a requirement in one area may not be used to satisfy a requirement in another area. All courses must be completed with a "C" or better.

Students must apply for IGETC Certification through the Admissions and Records Office during the semester in which requirements will be completed.

While IGETC is popular with transfer students, it may not be the best choice for you. Depending on your major, it may be best to follow the UC campus GE pattern. The UC Transfer Preparation Paths at <http://admission.universityofcalifornia.edu/transfer/preparation-paths/index.html> and ASSIST Exploring Majors feature at www.assist.org include information about the specific UC majors that do not recommend IGETC. Students should see a counselor for advice and more complete information on the IGETC program.

****The courses on the following IGETC requirements page are approved at the time of printing. Check with a counselor or www.assist.org for the most recent list of approved courses.***

NOTE: Independent universities or out of state universities may accept the IGETC pattern. Check with the individual university and your counselor to verify.

IGETC FOR STEM MAJORS

Per IGETC Standards 1.6, students preparing for a major in science, technology, engineering or mathematics that are pursuing an Associate Degree for Transfer (ADT) for certain approved majors can defer two lower-division GE courses after transfer. **As of Fall 2016, only the Biology ADT and Chemistry ADT (active Fall 2016) have this option.**

This allows the students to concentrate on the lower division math and science courses required for a STEM major and indicates that students can take the following courses AFTER transfer:

- One remaining lower-division general education course in Area 3;*
- One remaining lower-division general education course in Area 4;*
- One course in Area 6 for UC-bound students who have not satisfied it through proficiency.*

*These deferred lower division courses must be replaced with calculus and/or science courses required by the major before transfer.

For CSU

If any specific AS-T degree allows IGETC for STEM Majors as its general education pattern, the specific courses that should replace the deferred lower division general education courses may be indicated on the Transfer Model Curriculum (TMC) for that discipline.

For UC

UC will accept IGETC for STEM if the UC school/college/major program to which the student transfers accepts partial IGETC certification. For information on the IGETC acceptance practices for each UC school/college/major program, see: <http://admission.universityofcalifornia.edu/counselors/files/transfer-admission-matrix.pdf>.

For CSU and UC

Alternatively, STEM students may complete the traditional IGETC. However, IGETC and IGETC for STEM Majors may not be appropriate for those colleges or majors which prefer that transfer students follow a more prescribed lower-division curriculum.

IGETC Certificate of Achievement

To find out more about transfer certificates see Certificate of Achievement program information located under Programs of Study in this catalog.



IGETC REQUIREMENTS
(UNIVERSITY OF CALIFORNIA & CALIFORNIA STATE UNIVERSITY)

Student's Name: _____ ID#: @ _____ Date: _____

Major: _____ Transfer To: _____ Counselor: _____

Completion of all the requirements in the **Intersegmental General Education Transfer Curriculum (IGETC)** will permit a student to transfer from Cypress College to a campus in either the California State University or the University of California system without the need, after transfer, to take additional lower division general education courses to satisfy campus general education requirements. However, students approaching readiness for transfer who are unable to complete one or two IGETC courses that are not required for admission to the university may request to complete IGETC after transferring. **A course or sequence of courses used to satisfy a requirement in one area may not be used to satisfy a requirement in another area. Completion of IGETC is NOT an admission requirement to CSU or UC.** It is **NOT** advisable for students who are pursuing majors that require extensive lower division preparation, such as engineering, to follow IGETC. Confer with your counselor regarding these requirements. Students must apply for IGETC certification or the IGETC Certificate of Achievement in Admissions and Records. All courses must be completed with grades of "C" or better. Courses must be at least 3 semester or 4 quarter units in order to meet IGETC requirements. Courses must be on the college's approved IGETC list at the time the course was completed.

(Check boxes accordingly) LEGEND: C=Completed IP=In Progress R=Remaining

| | | AP CREDIT or OTHER COLLEGE COURSE(S) | C | IP | R |
|------------|---|--------------------------------------|---|----|---|
| | AREA 1 – ENGLISH COMMUNICATION REQUIREMENT: CSU: 3 courses required, one from each group below; UC: 2 courses required, one each from Group A and B. | | | | |
| 1A | Group A: English Composition , 1 course (3 semester units/4-5 quarter units) ENGL 100C [∞] (100HC [∞]) | | | | |
| 1B | Group B: Critical Thinking / English Composition , 1 course (3 semester/4-5 quarter units) ENGL 103C [∞] (103HC [∞])(begin F15), 104C [∞] (104HC [∞]), 106C(begin F11) PHIL 172C (Note: Confer with a counselor if ENGL 102, PHIL 170, or SPCH 135 were completed prior to F93). | | | | |
| 1C | Group C: Oral Communication (CSU requirement only) , 1 course (3 semester/4-5 quarter units) COMM 100C [∞] (100HC [∞]) | | | | |
| | AREA 2 – MATHEMATICAL CONCEPTS AND QUANTITATIVE REASONING REQUIREMENT: 1 course (3 semester/4-5 quarter units) | | | | |
| *2A | MATH 100C, 115C, 120C [∞] , 130C, 141C, 150AC, 150BC, 250AC, 250BC PSY 161C [∞] (161HC [∞]) SOC 161C [∞] (161HC [∞]) | | | | |
| | AREA 3 – ARTS & HUMANITIES REQUIREMENT: At least 3 courses, with at least one from the Arts and one from the Humanities (9 semester or 12-15 quarter units) | | | | |
| 3A | Group A: ARTS ART 100C, 110C, 111C, 112C [∞] (112HC [∞]), 114C, 216C DANC 101C [∞] , 120C ENGL 125C [∞] (125HC [∞]) MAD 196C(begin F15) MUS 103C, 113C [∞] , 116C, 117C, 118C [∞] (118HC [∞]), 119C(begin F01), 120C THEA 100C, 102C(F95-F10);begin F13), 107C [∞] (107HC [∞]) | | | | |
| 3B | Group B: HUMANITIES ANTH 107C [∞] ENGL 102C [∞] (102HC [∞]), 110C [∞] , 111C [∞] , 208C [∞] , 211C, 212C, 221C, 222C, 234C [∞] (234HC [∞]), 239C [∞] , 243C(begin F15), 247C [∞] , 255C [∞] , 256C [∞] , 260C(begin F15) ETHS 130C [∞] (begin F03), 131C [∞] (formerly 141C), 151C [∞] (formerly 141C), 152C [∞] FREN 203C (LOTE), 204C (LOTE) HIST 110C [∞] (110HC [∞]), 111C [∞] (111HC [∞]), 112C [∞] (112HC [∞])(begin S04), 113C [∞] (113HC [∞]), 160C, 161C [∞] , 163C [∞] , 165C [∞] , 275C [∞] (begin S05) INDS 100C [∞] , 101C [∞] JAPN 203C (LOTE), 204C (LOTE) PHIL 100C [∞] (100HC [∞]), 101C, 110C, 120C, 135C, 160C, 201C(begin S05), 202C, 230C, 240C(begin S06)(formerly 225C) SPAN 202C (LOTE), 203C (LOTE), 204C (LOTE) | | | | |
| | AREA 4 – SOCIAL & BEHAVIORAL SCIENCES REQUIREMENT: At least 3 courses from at least two different disciplines or an interdisciplinary sequence (9 semester/12-15 quarter units) | | | | |
| 4 | ANTH 102C [∞] (102HC [∞]), 103C(formerly 203C), 104C, 105C, 106C, 107C [∞] , 121C [∞] , 225C COMM 120C [∞] ECON 100C [∞] (100HC [∞]), 105C [∞] (105HC [∞]), 110C [∞] , 120C(begin F16), 260C [∞] ETHS 101C [∞] (formerly 100C) (101HC [∞])(formerly 100HC), 129C [∞] , 130C [∞] , 131C [∞] , 150C [∞] (formerly 140C), 151C [∞] (formerly 141C), 152C [∞] , 153C [∞] , 160C [∞] , 170C [∞] , 171C [∞] , 235C [∞] (begin F16) GEOG 100C [∞] (100HC [∞]), 130C, 140C(end SU14), 160C, 260C [∞] HIST 110C [∞] (110HC [∞]), 111C [∞] (111HC [∞]), 112C [∞] (112HC [∞]), 113C [∞] (113HC [∞]), 135C(begin S04), 142C(end SU13), 143C, 151C, 152C, 160C [∞] , 161C [∞] , 163C [∞] , 165C [∞] , 170C [∞] (170HC [∞]), 171C [∞] (171HC [∞])(begin F03), 190C [∞] (formerly 162AC), 191C [∞] (formerly 162BC), 270C(begin S04), 275C [∞] (begin S05) HUSR 250C [∞] (begin S06), 255C [∞] (begin S06), 292C(begin S06) POSC 100C [∞] (100HC [∞]), 101C [∞] , 120C [∞] , 130C, 200C, 209C [∞] , 210C, 215C, 216C, 230C PSY 101C [∞] (101HC [∞]), 120C [∞] , 131C [∞] (formerly 237C), 139C, 145C(begin S06), 202C, 221C, 222C, 251C, 255C [∞] (begin S06) SOC 101C [∞] (101HC [∞]), 102C, 120C [∞] , 225C, 237C [∞] , 250C [∞] (begin S06), 275C(begin S05), 277C, 292C(begin S06) | | | | |

Programs of Study

| (Check boxes accordingly) LEGEND: C=Completed IP=In Progress R=Remaining | | AP CREDIT or OTHER COLLEGE COURSE(S) | C | IP | R |
|--|--|--------------------------------------|---|----|---|
| AREA 5 – PHYSICAL AND BIOLOGICAL SCIENCES REQUIREMENT: At least 2 courses, one from Group A and one from Group B; at least one course must include a laboratory (7-9 semester/9-12 quarter units). Group C is a new area that includes science labs that combine lecture and lab or lab only courses. | | | | | |
| 5A | GROUP A: PHYSICAL SCIENCES Physical Sciences w/lab: ASTR 116C [±] /117C [±] (116HC [±] /117HC [±]) CHEM 100C(begin F02), 101C(begin F03), 107C+, 111AC, 111BC, 201C(begin F14) GEOG 102C/102LC, 140C GEOL 100C [±] /101C+ (100HC [±])/101C+, 100C [±] /115C (100HC [±])/115C, 103C, 130C/131C PHYS 130C+, 201C, 202C, 210C, 211C, 221C, 222C, 223C Physical Sciences w/o lab: ASTR 116C [±] (116HC [±]) CHEM 103C GEOG 102C, 140C(begin F13) GEOL 100C [±] (100HC [±]), 120C, 125C, 130C, 190C+ | | | | |
| 5B | GROUP B: BIOLOGICAL SCIENCES Biological Sciences w/lab: ANTH 101C [±] (101HC [±]), 101LC, 210C(begin F16) BIOL 101C [±] (101HC [±]), 111C/112C+, 113C/114C+, 122C, 174C, 175C, 210C(begin F09), 230C, 231C(begin S07), 241C(begin S07), 276C(begin F15) Biological Sciences w/o lab: ANTH 101C [±] (101HC [±]) BIOL 102C, 103C, 111C, 113C, 277C(begin F15), 278C(begin F15) | | | | |
| 5C | GROUP C: PHYSICAL and BIOLOGICAL SCIENCE LABORATORIES All science labs that combine lecture and lab or lab only courses: ANTH 101LC ASTR 117C [±] (117HC [±]) BIOL 101C [±] (101HC [±]), 112C+, 114C+, 122C, 127C, 128C+, 174C, 175C, 210C(begin F09), 230C, 231C(begin S07), 240C, 241C(begin S07), 276C(begin F15) CHEM 100C(begin F02), 101C(begin F03), 107C+, 111AC, 111BC, 201C(begin F14) GEOG 102LC GEOL 101C, 103C, 115C, 131C PHYS 130C+, 201C, 202C, 210C, 211C, 221C, 222C, 223C | | | | |
| AREA 6A – LANGUAGE OTHER THAN ENGLISH (LOTE): UC requirement only REQUIREMENT: Complete one of the following: | | | | | |
| 6A | <ol style="list-style-type: none"> Complete 2 years of high school course work in a language other than English (in the same language) with a grade of "C" or better. Complete course 102C[±] (102HC[±]) or higher level in a foreign language at Cypress College or equivalent courses at another college or university. Completion with "C" or better of 2 years of formal schooling at the 6th grade level or higher at an institution where the language of instruction is not English. Students unable to provide documentation need to have passed one of the exams listed below or take the appropriate college course(s). Earn the appropriate score on the SAT II Subject Test in languages other than English. See a counselor for score requirements. Earn a score of 3 or higher on the Advanced Placement Language Other than English Test. Earn a score of 5 or higher on the International Baccalaureate Higher Level Exam in a language other than English. Satisfactory completion of an achievement test administered by a community college, university, or college in a language other than English. This test will have to assess the student's proficiency at the level equivalent to two years of high school language. Earn an A, B, or C on Language Other than English "O" level exam. Earn a score of 5, 6, or 7 on Language Other than English International "A" Level Exam. Earn a "C" or better in a Defense Language Institute course. Cypress College courses that meet the proficiency level: CHIN 102C FREN 102C, 203C, 204C JAPN 102C, 203C(begin F05), 204C(begin F05) PORT 102C(begin S06) SPAN 102C [±] (102HC [±]), 201C, 202C, 203C, 204C Note: A higher-level language course can be used to meet language proficiency. Examples: FREN 203C or SPAN 202C. Students completing such courses will satisfy both the 3B Area and validate the proficiency level requirement. <i>These courses are identified in the 3B area as (LOTE).</i> | | | | |
| CSU GRADUATION REQUIREMENT IN U.S. HISTORY, CONSTITUTION, AND AMERICAN IDEALS (Not part of IGETC, may be completed prior to transfer.) (6 semester units, one course from Group A and one course from Group B) | | | | | |
| Group A (U.S. Constitution & Government): POSC 100C [±] (100HC [±]), 101C | | | | | |
| Group B (U.S. History): ETHS 101C [±] (begin F04) (formerly 100C) (101HC [±]) (formerly 100HC), 130C, 131C, 160C HIST 170C [±] (170HC [±]), 171C [±] (171HC [±]), 190C (formerly 162AC), 191C (formerly 162BC) Note: Double Counting is allowed for this requirement with only 1 G.E. category. The CSU US History, Constitution, and American Ideals (AI) graduation requirement is not part of IGETC. These courses may also be used to satisfy the UC American History & Institution requirement if not completed in high school. Since requirements vary, it is advisable to check the catalog of the UC campus to which the student intends to transfer. | | | | | |
| LEGEND | | | | | |
| + Check with counselor for credit limitations for applicable courses in these departments: BIOL, CHEM, DANCE, ECON, GEOL, MATH, PHOT, PHYS, PSYCH, SOC and THEA. Specific credit limitation information is available at www.assist.org . * Note: Certain majors require specific Mathematics course(s). See a Counselor for details. ◇ Course may be used to satisfy requirements for one area only. ∞ The class also may be used to satisfy the Cypress College Associates Degree Cultural Diversity requirement. □ Duplicate credit not granted for the same cross-listed courses nor for non-honors and honors classes. ^ See CSU graduation requirement in U.S. History, Constitution, and American Ideals. NOTE: Underlining indicates a course is no longer offered at Cypress College. The notations reflected after classes represent either the time a class was approved or ended. | | | | | |

Please check the IGETC Certification list on www.assist.org and confer with a counselor for more information and to discuss your major requirements. See the Cypress College Catalog for information on how to receive an IGETC Certificate of Achievement upon completion of this pattern.

GENERAL EDUCATION CERTIFICATION (GE) and PASS ALONG

Students planning to graduate from the California State University or University of California systems must complete a minimum number of general education breadth courses. Cypress College is permitted to certify completion of the lower division general education requirement. Certification is not automatic. To meet general education requirements and obtain certification, students must:

- Complete the pattern of general education courses approved for Cypress College.
- Apply for GE certification through the Admissions and Records Office or online at www.CypressCollege.edu during the semester in which requirements will be completed or thereafter. Note: Students applying for completion of an approved Associate Degree at Cypress College requiring CSU GE or IGETC do not need to apply.

Students with transcripts from other educational institutions should see a counselor to obtain a supplemental “pass along” form which must be attached to the certification application. Courses completed at educational institutions outside the United States cannot be used for “pass along” and these courses must be evaluated by the university during the application process. Students do not have to be currently enrolled in Cypress College to apply for GE certification.

Description of Courses

The following section includes a description of every course which may be studied at Cypress College. The prerequisite(s) for the class is stated, if applicable. The program of instruction related to the numbering of courses is divided into major categories:

- College and university parallel courses (transfer courses) have title numbers ranging from 100 through 299. If appropriate to the student’s major, they usually will be accepted as transfer units to institutions of higher education for their full credit value.
- Several general education courses, in addition to occupational, vocational and technical courses will bear the title numbers ranging from 001 through 099 and generally are not transferable to institutions of higher education except as they apply to major programs in the California State Universities. Students are advised to confer with their counselors regarding the transferability of these courses to particular colleges or universities. Students entering Cypress College should consult with college counselors in planning their programs of study. The faculty and counseling staff of Cypress College will assist students in every way possible to make wise vocational and educational plans. Students, however, must assume the responsibility for their own choices and plans.

NON-DEGREE CREDIT courses indicated as NON-DEGREE CREDIT do earn credit, but the credit is not counted toward the Associate Degree. These classes are intended to help students gain the skills they need to perform in college level degree applicable courses. NON-DEGREE CREDIT classes count toward the following categories: Athletic Eligibility, Social Security Benefits, Work Study and Financial Aid, Veterans’ Benefits, Associated Student Body Office and Full-Time Status. All other Cypress College courses are degree applicable.

UC/CSU designated courses are transferable to the campuses of the University of California and the California State University system. Those courses that are not marked **UC** are not transferable to the University of California campuses. Confer with a counselor for information regarding transferability of courses marked **UC Limitation**. Students can view a complete list of Cypress College courses that are transferable to the UC at www.assist.org.

CSU GE — These courses satisfy general education breadth requirements for California State Universities (CSU campuses).

AA GE (Native) — Courses which satisfy general education requirements for the Associate Degree.

IGETC — Intersegmental General Education Transfer Curriculum is a series of courses that Cypress College students may use to satisfy lower division general education requirements at any CSU or UC campus.

CUL DIV — Courses with the **Cultural Diversity** designation are ones which meet the Cypress College Cultural Diversity graduation requirement.

RDG — Courses with the Reading Proficiency designation are ones which meet the Cypress College reading proficiency graduation requirement.

Standard Definitions

Definition of *Advisory*

When a course has an *advisory*, it means that a student is recommended to have certain preparation before entering the course. The preparation is considered advantageous to a student’s success in the course. Since the preparation is recommended, the student is advised, but not required, to meet the condition before or in conjunction with enrollment in the course or educational program (eligibility for ENGL 100 C is recommended for POSC 100 C).

Definition of *Articulation*

Articulation agreements define how courses will transfer from one institution to another. Cypress College maintains major and/or course-to-course articulation agreements with most public universities and many independent colleges and universities in the state of California. The agreements with the public institutions are listed on www.assist.org which is the official repository for articulation in the state. Many independent institutions have articulation information available on their websites. In addition, agreements with public and independent institutions are located in the Transfer Center and Counseling Center.

Definition of *Associate Degrees for Transfer*

California Community Colleges are now offering Associate Degrees for Transfer (ADT) to the CSU. These may include Associate in Arts (AA-T) or Associate in Science (AS-T) degrees. These degrees are designed to provide a clear pathway to a CSU major and baccalaureate degree. California Community College students who are awarded an AA-T or AS-T are guaranteed admission with junior standing somewhere in the CSU system and given priority admission consideration to their local CSU campus or to a program that is deemed similar to their community college major. This priority does not guarantee admission to a specific campus.

The ADT degree is intended for students who plan to complete a bachelor’s degree in a similar major at a CSU campus. Students who have

been awarded an ADT are able to complete their remaining requirements for the 120-unit baccalaureate degree within 60 semester or 90 quarter units. To view the most current list of Cypress College Associate Degrees for Transfer and to find out which CSU campuses accept each degree, please reference www.CypressCollege.edu/services/transfer or www.adegreewithaguarantee.org

Current and prospective community college students are encouraged to meet with a counselor to review their options and learn how to develop an educational plan that best meets their goals and needs as it relates to university admission and transfer requirements.

Definition of ASSIST

ASSIST is a computerized student-transfer information system that can be accessed over the World Wide Web. It displays reports of how course credits earned at one California college or university can be applied when transferred to another. ASSIST is the official repository of articulation for California's colleges and universities and therefore provides the most accurate and up-to-date information available about student transfer in California. ASSIST is available at: www.assist.org.

Students should consult the ASSIST database for specific information on course agreements. The counselors and Transfer Center staff can help students interpret this information.

Definition of Corequisite

When a course has a *corequisite*, it means that a student is required to take another course concurrent with or prior to enrollment in the course. Knowing the information presented in the corequisite course is considered necessary in order for a student to be successful in the course (completion of, or concurrent enrollment in, ASTR 116 C is required for ASTR 117 C).

It is the student's obligation to know and meet course corequisites. These are stated in the course description section of the *Class Schedule* and the current *College Catalog*. The student may be required to file proof of meeting corequisites on the first day of class.

Definition of Course Identification Numbering System (C-ID)

The Course Identification Numbering System (C-ID) is a statewide numbering system independent from the course numbers assigned by local California community colleges. A C-ID number next to a course signals that participating California colleges and universities have determined that courses offered by other California community colleges are comparable in content and scope to courses offered on their own campuses, regardless of their unique titles or local course number. Thus, if a schedule of classes or catalog lists a course bearing a C-ID number, for example COMM 110, students at that college can be assured that it will be accepted in lieu of a course bearing the C-ID COMM 110 designation at another community college. In other words, the C-ID designation can be used to identify comparable courses at different community colleges. However, students should always go to www.assist.org to confirm how each college's course will be accepted at a particular four-year college or university for transfer credit.

The C-ID numbering system is useful for students attending more than one community college and is applied to many of the transferable courses students need as preparation for transfer. Because these course requirements may change and because courses may be modified and qualified for or deleted from the C-ID database, students should always check with a counselor to determine how C-ID designated courses fit into their educational plans for transfer.

Students may consult the ASSIST database at www.assist.org for specific information on C-ID course designations. Counselors can always help students interpret or explain this information.

Definition of Electives

An *elective* is a course not required for graduation or for the fulfillment of requirements for a program. For example, a science student might take electives from non-science areas, which might include history, art, English, music, or political science. A history student might take electives from biology, chemistry, art, music or English literature. To assist in choosing electives, a student should consult a counselor and the catalog of the college to which he/she expects to transfer.

Definition of Prerequisite

When a course has a *prerequisite*, it means that a student must have certain knowledge to be successful in the course. The prior knowledge may be a skill, an ability (speaks and writes Spanish fluently), a test score, or a successful completion of a prior course (must have completed ENGL 060 C with a grade of "C" or better). Completion of the prerequisite is required prior to enrolling in the course. Successful completion of a prerequisite course means that a grade of *Pass*, or *C*, or better was earned; *D*, *F*, or *No Pass* grades are not acceptable.

Prerequisites for all courses are explained in the *Class Schedule* and the current *College Catalog* under the listing for the class. It is the student's obligation to know and meet course prerequisites. The student may be required to file proof of meeting prerequisites on the first day of class.

Definition of Unit

Course work at Cypress College is measured in terms of semester units. In general, a unit equals eighteen hours of lecture or fifty-four hours of laboratory work per semester. Some courses combine different types of approaches and the units are adjusted accordingly. Hours per week for short-term courses are prorated based on the semester course hours.

TRANSFER CREDIT — BACCALAUREATE DEGREES

Cypress College certifies that the following classes listed (by instructional divisions) are baccalaureate-level classes and are transferable to any campus of the California State University system for credit toward its baccalaureate degrees:

Business and Computer Information Systems — All classes numbered 100 C through 299 C.

Career Technical Education — All classes numbered 100 C through 299 C; Aviation 050 C and Photography 050 C.

Counseling and Guidance — All classes numbered 100 C through 299 C.

Fine Arts — All classes numbered 100 C through 299 C.

Health Science — All classes numbered 100 C through 299 C.

Language Arts — All classes numbered 100 C through 299 C.

Physical Education — All classes numbered 100 C through 299 C.

Science/Engineering/Mathematics — All classes numbered 100 C through 299 C.

Social Science — All classes numbered 100 C through 299 C.

Note: All Honors classes offered at Cypress College are transferable to any campus of the California State University system.

GENERAL EDUCATION AND BASIC SKILLS PROGRAM LEARNING OUTCOMES

The General Education and Basic Skills Program is considered as one complete program. The General Education and Basic Skills Student Learning Outcomes are broad categories that include courses approved for the Cypress College AA/AS (Native) Degree General Education, the California State University General Education, and the Intersegmental General Education Transfer Curriculum (IGETC) pathways, and the prerequisite basic skills courses. The Cypress College Institutional Learning Outcomes adopted in Spring 2004 were reviewed and written as statements rather than topics in four major areas or competencies. Portions of Cabrillo College's General Education and Basic Skills SLOs were used with permission.

I. Breadth of Knowledge and Experiences

Students will possess a breadth of knowledge and experiences from the following areas:

- A. Humanities and the Arts
 1. Aesthetic Awareness: Examine the visual arts, dance, music, and/or literature of diverse cultures.
 2. Critical Analysis: Assess the methods used to create art and interpret its literal and/or symbolic meaning.
 3. Creativity: Engage in artistic creative endeavors.
- B. Natural Sciences and Mathematics
 1. Scientific Principles: Demonstrate an understanding of scientific principles that govern the natural and mathematical universe.
 2. The Scientific Method: Apply scientific processes to solve problems and measure and observe natural phenomena, including the design, performance, and analysis of experiments.
 3. Mathematical Systems: Demonstrate an understanding of mathematics as a symbolic, universal language.
- C. Social Sciences
 1. Cultural Competence: Demonstrate knowledge and understanding of the feelings, opinions, and/or values of other people and cultures.
 2. Global Perspective: Recognize important economic, political, social, and historical issues and values in one's own community, state, country, and/or the world.
 3. Human Experience: Use qualitative and/or quantitative methods to study the human aspects of the world.
- D. Physical Education
 1. Fitness: Understand the development, care, and exercise of the human body through movement.
 2. Health and Nutrition: Understand and apply the principles of nutrition, hygiene, and safety to develop mental and physical well-being.
 3. Movement Competence: Perform learned skills competently.

II. Communication

Students will communicate effectively, which means the ability to

- A. Read:
 1. Comprehend, interpret, and/or evaluate various written information.

- B. Write:
 1. Communicate thoughts, ideas, information, and messages in writing.
 2. Compose and create documents with correct grammar, spelling, punctuation, and appropriate language, style, and format.
 3. Check, edit, and revise written work for correct information, appropriate emphasis, form, style, and grammar.
- C. Listen:
 1. Sense and appropriately perceive and respond to verbal and/or nonverbal messages.
- D. Communicate:
 1. Organize ideas and communicate verbal and/or non-verbal messages appropriate to the audience and the situation.
 2. Communicate clearly and ask relevant questions in conversations, discussions, group activities, and/or public speaking.

III. Critical Thinking and Information Competency

Students will think critically, which is characterized by the ability to

- A. Analyze:
 1. Recognize and apply rules and principles to new situations.
 2. Use logic (induction and deduction) to draw conclusions from information given.
 3. Differentiate between facts, inferences, assumptions, and/or conclusions.
- B. Compute:
 1. Use basic numerical concepts, such as whole numbers, percentages, and estimates of math without a calculator.
 2. Use tables, graphs, charts, and diagrams to explain concepts or ideas.
 3. Use basic geometrical shapes, such as lines, angles, shapes, and space.
- C. Research:
 1. Effectively and ethically acquire, organize, analyze, synthesize, evaluate and communicate information.
 2. Determine which technology resources will produce the desired results.
- D. Solve Problems:
 1. Define a problem and identify its components.
 2. Create a plan of action to resolve the issue.
 3. Execute and evaluate the effectiveness of the plan.

IV. Self Development

Students will develop self-awareness and responsibility by means of the following:

- A. Self Integration
 1. Understand the person as an integrated physiological, social, and psychological being.
- B. Personal Responsibility
 1. Develop skills and identify values for personal growth and life-long learning.
- C. Global Citizenship
 1. Understand the interconnection between current events, ethics, and personal and societal choices within our world.



***Programs
and
Course Descriptions***

Course Prefixes

| | | | |
|------|---|--------------|---------------------------------------|
| ACCT | Accounting | HIST | History |
| AC/R | Air Conditioning/Refrigeration | HRC | Hotel, Restaurant, Culinary Arts |
| ACR | Automotive Collision Repair | HS | Health Science |
| AJ | Administration of Justice | HSCE | Health Science — Continuing Education |
| ANTH | Anthropology | HUSR | Human Services |
| ART | Art | INDS | Interdisciplinary Studies |
| ASTR | Astronomy | JAPN | Japanese |
| AT | Automotive Technology | JOUR | Communications/Journalism |
| ATC | Aviation and Travel Careers | KIN | Kinesiology |
| AVIA | Now ATC | LIB | Library |
| BIOL | Biology | MAD | Media Arts Design |
| CHEM | Chemistry | MATH | Mathematics |
| CHIN | Chinese | MGT | Management |
| CIS | Computer Information Systems (Business) | MKT | Marketing |
| COMM | Communication Studies | MM | Multimedia |
| COUN | Counseling and Student Development | MORT | Mortuary Science/Funeral Service |
| CSCI | Computer Science (Mathematics) | MUS | Music |
| CTRP | Court Reporting | MUSA | Applied Music |
| DA | Dental Assisting | NURS | Nursing |
| DANC | Dance | PE (now KIN) | Physical Education |
| DH | Dental Hygiene | PHIL | Philosophy and Religious Studies |
| DMS | Diagnostic Medical Sonography | PHOT | Photography |
| ECON | Economics | PHSC | Physical Science |
| EDU | Education | PHYS | Physics |
| ELEC | Electricity | PORT | Portuguese |
| ENGL | English | POSC | Political Science |
| ENGR | Engineering | PSY | Psychology |
| ENGT | Engineering Technology | PT | Psychiatric Technology |
| ESL | English as a Second Language | RADT | Radiologic Technology |
| EST | Energy Sustainable Technology | REC | Recreation |
| ETHS | Ethnic Studies | SOC | Sociology |
| FREN | French | SOSC | Social Science |
| GEOG | Geography | SPAN | Spanish |
| GEOL | Geology | THEA | Theater Arts |
| GIS | Geographic Information Systems | WKEX | Work Experience |
| HI | Health Information Technology | | |

Accounting

Division of Business and Computer Information Systems

Division Dean — Henry Hua

Faculty
Ann Sheridan-Solis

Counselor
Robert Grantham

PROGRAM LEARNING OUTCOMES (PLOs)

Accounting

A student who completes the Accounting field of study will be able to:

- Acquire problem analysis skills including analyzing transactions, performing break even analysis, and utilizing accounting software to design suitable solutions
- Enhance his/her employment opportunity in the specific area of accounting

ASSOCIATE IN SCIENCE DEGREE

ACCOUNTING

Program Code: 1S03761

This curriculum is designed to prepare the student for employment in the field of general bookkeeping and accounting. A graduate from this program should be equipped to meet the demands of any organization requiring skills in general accounting, cost accounting and analysis of financial information.

To earn an Associate Degree students must complete: (1) all major course requirements with a minimum grade of "C"; (2) 25 units of General Education Graduation Requirements; (3) the cultural diversity and reading requirements; (4) any elective courses to complete a minimum of 60 units; and, (5) have a minimum GPA of 2.0. At least 50% of all major course work must be completed at Cypress College.

Courses that fulfill major requirements for an Associate Degree at Cypress College might not be the same as those required for completing the major at a transfer institution offering a Baccalaureate Degree. For information on specific university requirements, please consult with your counselor, or visit the Transfer Center.

Required courses are listed in suggested sequence:

| Course # | Title | Units |
|-------------|--|-----------|
| ACCT 101 C | Financial Accounting | 4 |
| CIS 111 C | Computer Information Systems | 3 |
| ACCT 102 C | Managerial Accounting | 4 |
| ACCT 190 C | Accounting Systems Design and Applications | 3 |
| MGT 111 C | Business Communications | 3 |
| | or | |
| MGT 211 C | Writing for Business | (3) |
| *ECON 105 C | Principles of Economics — Micro | 3 |
| | or | |
| *ECON 105HC | Honors Principles of Economics | (3) |
| | or | |
| ECON 110 C | Survey of Economics | (3) |
| ACCT 201 C | Intermediate Accounting | 3 |
| ACCT 011 C | Payroll Accounting | 2 |
| ACCT 202 C | Cost Accounting | 3 |
| ACCT 204 C | Accounting-Government and Nonprofit Entities | 3 |
| | Total Units Required | 31 |

*A score of 3 or higher on the Advanced Placement (AP) Economics (micro) exam meets this requirement upon petition through Admissions and Records. See a counselor for more information.

ACCOUNTING CERTIFICATE Program Code: 1C21094

This program is designed to prepare the student for entry level positions and/or professional advancement in a wide variety of accounting jobs. These jobs include general accounting, governmental accounting, cost accounting, payroll, inventory management, asset management, credit and collections, financial analysis, etc.

To earn a certificate, complete the required courses as listed with a minimum grade of "C." At least 50% of all course work must be completed at Cypress College.

Required courses are listed in suggested sequence:

| Course # | Title | Units |
|------------|--|-----------|
| ACCT 101 C | Financial Accounting | 4 |
| CIS 111 C | Computer Information Systems | 3 |
| ACCT 102 C | Managerial Accounting | 4 |
| ACCT 190 C | Accounting Systems Design and Applications | 3 |
| MGT 111 C | Business Communications | 3 |
| | or | |
| MGT 211 C | Writing for Business | (3) |
| ACCT 201 C | Intermediate Accounting | 3 |
| ACCT 011 C | Payroll Accounting | 2 |
| ACCT 202 C | Cost Accounting | 3 |
| ACCT 204 C | Accounting Government and Nonprofit Entities | 3 |
| | Total Units Required | 28 |

ASSOCIATE IN SCIENCE IN BUSINESS ADMINISTRATION FOR TRANSFER DEGREE (AS-T) Program Code: 1S31295

This curriculum is designed to provide an opportunity for the Business Administration major to achieve an Associate in Science in Business Administration for Transfer Degree (AS-T in Business Administration) which completes the first and second year requirements for transfer into the CSU system.

Advanced degrees and/or professional certificates, such as a baccalaureate degree, are required for those considering professional careers. Completion of this curriculum will demonstrate a commitment to the field and provide comprehensive preparation for further academic study through upper-division course work. This curriculum specifically prepares the prospective transfer student for upper division course work in Business Administration or a similar major at a California State University (CSU) campus. Students should consult a counselor, the Transfer Center and the catalog of the transfer college or university to plan a specific program of study to meet the college or university's requirements. Note: Courses that fulfill major requirements for an Associate Degree for Transfer at Cypress College might not be the same as those required for completing the major at all transfer institutions offering a Baccalaureate Degree.

The Student Transfer Achievement Reform Act (Senate Bill 1440, now codified in California Education Code sections 66746–66749) guarantees admission to a California State University (CSU) campus for any community college student who completes an “associate degree for transfer,” a newly established variation of the associate degrees traditionally offered at a California community college. The AS-T is intended for students who plan to complete a bachelor's degree in a similar major at a CSU campus. Students completing these degrees (AS-T) are guaranteed admission to the CSU system, but not to a particular campus or major. Students transferring to a CSU campus that does accept the AS-T will be required to complete no more than 60 units after transfer to earn a bachelor's degree (unless the major is designated “high-unit” major). This degree may not be the best option for students intending to transfer to a particular CSU campus or to a university or college that is not part of the CSU system. Students should consult with a counselor when planning to complete the degree for more information on university admission and transfer requirements.

Students successfully completing the AS-T in Business Administration will gain knowledge in accounting, business communications, information technologies, finance, law, management, and marketing. Because business is such a broad field with many emphases and majors, this degree will provide the student a broad overview of the possible fields of study in various business areas.

To earn an AS-T in Business Administration students must complete the following requirements: (1) a minimum of 27 semester units or 40.5 quarter units in the Business Administration major with a minimum grade of “C”; (2) California State University General Education Breadth requirements (CSU GE Breadth) or the Intersegmental General Education Transfer Curriculum (CSU IGETC); (3) elective courses to complete a minimum of 60 units of CSU transferable course work; (4) have an overall GPA of 2.0.

Required Core Courses are listed in suggested sequence. (17 units)

| | Units |
|------------|-------|
| ACCT 101 C | 4 |
| ACCT 102 C | 4 |
| ECON 100 C | 3 |
| | or |
| ECON 100HC | (3) |
| ECON 105 C | 3 |
| | or |
| ECON 105HC | (3) |
| MGT 240 C | 3 |

List A: Select one of the following: (4 units)

| | Units |
|------------|-------|
| MATH 130 C | 4 |
| MATH 120 C | 4 |
| MATH 115 C | 4 |

List B: Select two of the following or any courses from List A not already chosen. (6–8 units)

| | Units |
|--------------------|--------------|
| CIS 111 C | 3 |
| MGT 161 C | 3 |
| | or |
| MGT 211 C | (3) |
| Total Units | 27–29 |

ACCOUNTING TRANSFER PROGRAM

Students should consult a counselor or www.assist.org for lower division major requirements for most California public universities. (See the Standard Definitions section of the catalog for a description of ASSIST.) Students transferring to an independent college/university should consult the catalog of the individual school and a counselor for lower division major requirements.

Accounting (ACCT)

ACCT 011 C Payroll Accounting 2 Units

Prerequisite: ACCT 101 C.

Term hours: 36 lecture. This course is a thorough study of payroll computation techniques and payroll taxes. The course is of a non-technical nature and is intended to give students a practical working knowledge of current payroll tax laws. Pass/No Pass/Letter Grade Option.

ACCT 101 C Financial Accounting 4 Units

Prerequisite: MATH 038 C or MATH 040 C or MATH 041 C with grades of “C” or better.

Term hours: 90 lecture. A course in beginning accounting meets transfer requirements to four-year colleges and universities and provides a foundation for vocational accounting or other areas of business administration. This course describes and illustrates financial accounting theory and principles, including classification of accounts, recording of financial transactions, presentation and analysis of financial statements, and fundamentals of the accounting cycle as applied to service and merchandising enterprises. Credit by Examination. (UC/CSU, C-ID: ACCT 110)

ACCT 102 C Managerial Accounting**4 Units***Prerequisite: ACCT 101 C with a grade of "C" or better.**Advisory: CIS 111 C and CIS 103 C.*

Term hours: 90 lecture. This is the study of how managers use accounting information in decision-making, planning, directing operations and controlling. Focuses on cost terms and concepts, cost behavior, cost structure and cost-volume-profit analysis. Includes issues relating to cost systems, cost control, profit planning, and performance analysis in manufacturing and service environments. (UC/CSU, C-ID: ACCT 120)

ACCT 190 C Accounting Systems Design and Applications**3 Units***Prerequisite: ACCT 101 C.**Advisory: Knowledge of spreadsheet software recommended.*

Term hours: 54 lecture and 18 laboratory. The course offers the student a hands-on approach to computerized accounting. Students will explore different manual and computerized accounting systems such as General Ledger, Accounts Receivable, Accounts Payable, Payroll and Inventory. \$3.00 Material Fee-Payable at Registration. (CSU)

ACCT 201 C Intermediate Accounting**3 Units***Prerequisite: ACCT 101 C.*

Term hours: 54 lecture. This course provides an in-depth analysis of accounting theory and practice. Emphasis is placed on the changing nature of principles and practices, the application of present-value concepts, the complexity of transactions that arise in a multifaceted economic environment, and the use of accounting information in decision making. (CSU)

ACCT 202 C Cost Accounting**3 Units***Prerequisite: ACCT 102 C with a grade of "C" or better.*

Term hours: 54 lecture. This course covers the nature, objectives, and procedures of cost accounting and managerial control of operations. It includes job, process, and standard costing; accounting for manufacturing overhead, direct materials and direct labor; budgeting; and cost records and reports. (CSU)

ACCT 204 C Accounting-Government and Nonprofit Entities**3 Units***Prerequisite: ACCT 101 C.*

Term hours: 54 lecture. This course introduces financial accounting concepts as they apply to governmental and not-for-profit entities, such as federal, state and local governments, school districts, universities, hospitals, religious and social service organizations. The focus is on the principles and procedures of accounting, financial reporting, budgeting and auditing requirements. (CSU)

ACCT 295 C Accounting Internship**1 to 3 Units***Advisory: ACCT 101 C.*

Term hours: 18–54 hours lecture. This course is designed to give the student credit for work experience at a related occupational worksite, while being concurrently enrolled in a vocational major. For each unit of credit, a minimum of 75 paid or 60 unpaid worksite internship hours is required. The internship allows students to apply knowledge gained in college courses to an actual work setting, sample career choices and improve job-readiness skills. Supplemental reading and course assignments required. May be taken for credit 4 times. Open Entry/Open Exit. Pass/No Pass/Letter grade Option. (CSU)

Administration of Justice

Division of Career Technical Education

Division Dean — Kathleen Reiland, Interim*Counselor*

Jane Jepson

Administration of Justice (AJ)

AJ 110 C Introduction to Criminal Justice**3 Units**

Formerly AJ 100 C

Term hours: 54 lecture. This course introduces students to the characteristics of the criminal justice system in the United States. Focus is placed on examining crime measurement, theoretical explanations of crime, responses to crime, components of the system, and current challenges to the system. The course examines the evolution of the principles and approaches utilized by the justice system and the evolving forces which have shaped those principles and approaches. Although justice structure and process is examined in a cross cultural context, emphasis is placed on the US justice system, particularly the structure and function of US police, courts, and corrections. Students are introduced to the origins and development of criminal law, legal process, and sentencing and incarceration policies. (CSU)

AJ 120 C Concepts of Criminal Law**3 Units**

Formerly AJ 110AC

Prerequisite: Completion of or concurrent enrollment in AJ 110 C.

Term hours: 54 lecture. This course offers an analysis of the doctrines of criminal liability in the United States and the classification of crimes against persons, property, morals, and public welfare. Special emphasis is placed on the classification of crime, the general elements of crime, the definitions of common and statutory law, and the nature of acceptable evidence. This course utilizes case law and case studies to introduce students to criminal law. The completion of this course offers a foundation upon which upper-division criminal justice course will build. The course will also include some limited discussion of prosecution and defense decision making, criminal culpability, and defenses to crimes. (CSU)

AJ 140 C Criminal Investigation**3 Units**

Term hours: 54 lecture. This course addresses the techniques, procedures, and ethical issues in the investigation of crime, including organization of the investigative process, crime scene searches, interviewing and interrogating, surveillance, source of information, utility of evidence, scientific analysis of evidence and the role of the investigator in the trial process. (CSU)

AJ 160 C Community and the Justice System**3 Units**

Term hours: 54 lecture. This course examines the complex, dynamic relationship between communities and the justice system in addressing crime and conflict with an emphasis on the challenges and prospects of administering justice within a diverse multicultural population. Topics may include the consensus and conflicting values in culture, religion, and law. (UC/CSU)

Administrative Support — See Computer Information Systems (CIS)

Aeronautics — See Aviation and Travel Careers (ATC)

Air Conditioning and Refrigeration

Division of Career Technical Education

Division Dean — Kathleen Reiland, Interim

Faculty

Richard Hock
Douglas Sallade
Carlos Urquidi

Counselor

Jane Jepson

PROGRAM LEARNING OUTCOMES (PLOs)

A student that completes the Air Conditioning and Refrigeration program will have acquired a specific skill set and will have achieved the necessary competencies for HVAC-R industry employment.

ASSOCIATE IN SCIENCE DEGREE

AIR CONDITIONING AND REFRIGERATION

Program Code: 1S03774

This program is designed as the bridge between Engineering and Service Technology. It will provide students with technical skills to support engineering applications. Graduates of the program will be at the leading edge of the application of new engineering solutions to production in industry.

To earn an Associate Degree students must complete: (1) all 38.5–39 units of Air Conditioning and Refrigeration course requirements for the Certificate in Air Conditioning and Refrigeration with a minimum grade of “C”; (2) 25 units of General Education Graduation Requirements, including the cultural diversity and reading requirements and any elective courses to complete a minimum of 60 units; and, (3) have a minimum GPA of 2.0. At least 50% of all major course work must be completed at Cypress College. Courses that fulfill requirements for an Associate Degree at Cypress College might not be the same as those required for completing the major at a transfer institution offering a Baccalaureate Degree. For information on specific university requirements, please consult with your counselor, or visit the Transfer Center.

| Required courses are listed in suggested sequence: | | Units |
|---|---|----------------|
| AC/R 100 C | Principles of Thermodynamics and Heat Transfer | 3 |
| AC/R 110 C | Air Conditioning I | 3 |
| AC/R 120 C | Piping Practice, Tools and Safety | 2 |
| AC/R 036 C | Refrigerants, Charging and Recovery | 1 |
| AC/R 137 C | Blueprints and Dimension Analysis | 2 |
| AC/R 105 C | Electricity for Air Conditioning and Refrigeration I | 3 |
| AC/R 115 C | Gas Heating and Carbon Monoxide | 2 |
| AC/R 145 C | Load Calculations for Heating and Cooling | 2 |
| AC/R 106 C | Electricity for Air Conditioning and Refrigeration II | 3 |
| AC/R 210 C | Commercial Refrigeration | 3 |
| AC/R 220 C | A/C Controls and Energy Management | 2 |
| AC/R 230 C | Heat Pumps | 2 |
| AC/R 205 C | Commercial Air Conditioning | 3 |
| AC/R 215 C | Codes and Estimating for HVACR | 3 |
| AC/R 035 C | Building Commissioning | 2 |
| AC/R 055 C | Technician Customer Relations | 2 |
| AC/R 050 C | HVAC-R Special Projects | .5–1 |
| Total Units Required | | 38.5–39 |

AIR CONDITIONING AND REFRIGERATION CERTIFICATE

Program Code: 1C31173

Primary emphasis of this program is to prepare the student with job entry-level skills. Although further training must be done on the job, the student will have a strong background in fundamental skills of refrigeration, electricity, mathematics, communication skills, and drafting.

To earn a certificate, students must complete the required courses as listed with a minimum grade of “C.” At least 50% of all course work must be completed at Cypress College.

| Required courses are listed in suggested sequence: | | Units |
|---|---|----------------|
| AC/R 100 C | Principles of Thermodynamics and Heat Transfer | 3 |
| AC/R 110 C | Air Conditioning I | 3 |
| AC/R 120 C | Piping Practice, Tools and Safety | 2 |
| AC/R 036 C | Refrigerants, Charging and Recovery | 1 |
| AC/R 137 C | Blueprints and Dimension Analysis | 2 |
| AC/R 105 C | Electricity for Air Conditioning and Refrigeration I | 3 |
| AC/R 115 C | Gas Heating and Carbon Monoxide | 2 |
| AC/R 145 C | Load Calculations for Heating and Cooling | 2 |
| AC/R 106 C | Electricity for Air Conditioning and Refrigeration II | 3 |
| AC/R 210 C | Commercial Refrigeration | 3 |
| AC/R 220 C | A/C Controls and Energy Management | 2 |
| AC/R 230 C | Heat Pumps | 2 |
| AC/R 205 C | Commercial Air Conditioning | 3 |
| AC/R 215 C | Codes and Estimating for HVACR | 3 |
| AC/R 035 C | Building Commissioning | 2 |
| AC/R 055 C | Technician Customer Relations | 2 |
| AC/R 050 C | HVAC-R Special Projects | .5–1 |
| Total Units Required | | 38.5–39 |

AIR CONDITIONING BUILDING COMMISSIONING CERTIFICATE **Program Code: 1C31185**

The Building Commissioning Certificate provides students with a career path for attaining the communication skills, practical knowledge, and technical training necessary for pursuing a career in building commissioning certification. Students completing this certificate will develop an advanced understanding of the building commissioning process.

To earn this certificate, complete the required courses as listed with a minimum grade of “C.” At least 50% of all major course work must be completed at Cypress College.

| Required courses are listed in suggested sequence: | | Units |
|---|--|--------------|
| AC/R 100 C | Principles of Thermodynamics and Heat Transfer | 3 |
| AC/R 110 C | Air Conditioning I | 3 |
| AC/R 120 C | Piping Practice, Tools and Safety | 2 |
| AC/R 036 C | Refrigerants, Charging and Recovery | 1 |
| AC/R 137 C | Blueprints and Dimension Analysis | 2 |
| AC/R 105 C | Electricity for Air Conditioning and Refrigeration I | 3 |
| AC/R 115 C | Gas Heating and Carbon Monoxide | 2 |
| AC/R 125 C | Boiler and Hydronic Heating | 2 |
| AC/R 135 C | Solar Energy for Heat and Cool | 2 |
| AC/R 145 C | Load Calculations for Heating and Cooling | 2 |
| AC/R 035 C | Building Commissioning | 2 |
| Total Units Required | | 24 |

AIR CONDITIONING CODES AND ESTIMATING CERTIFICATE **Program Code: 1C31106**

The Codes and Estimating Certificate provides students with a career path for attaining the communication skills, practical knowledge, and technical training necessary for pursuing a career in building codes and cost estimating. Students completing this certificate will develop an advanced understanding of building codes and cost estimating.

To earn this certificate, complete the required courses as listed with a minimum grade of “C.” At least 50% of all major course work must be completed at Cypress College.

| Required courses are listed in suggested sequence: | | Units |
|---|--|--------------|
| AC/R 137 C | Blueprints and Dimension Analysis | 2 |
| AC/R 036 C | Refrigerants, Charging and Recovery | 1 |
| AC/R 100 C | Principles of Thermodynamics and Heat Transfer | 3 |
| AC/R 110 C | Air Conditioning I | 3 |
| AC/R 105 C | Electricity for Air Conditioning and Refrigeration I | 3 |
| AC/R 115 C | Gas Heating and Carbon Monoxide | 2 |
| AC/R 125 C | Boiler and Hydronic Heating | 2 |
| AC/R 135 C | Solar Energy for Heat and Cool | 2 |
| AC/R 145 C | Load Calculations for Heating and Cooling | 2 |
| AC/R 215 C | Codes and Estimating for HVACR | 3 |
| Total Units Required | | 23 |

COMMERCIAL AIR CONDITIONING CERTIFICATE **Program Code: 1C31186**

The Commercial Air Conditioning Certificate provides students with a career path for attaining the communication skills, practical knowledge, and technical training necessary for pursuing a career in commercial building air conditioning. Students completing this certificate will develop an advanced understanding of commercial building air conditioning.

To earn this certificate, complete the required courses as listed with a minimum grade of “C.” At least 50% of all major course work must be completed at Cypress College.

| Required courses are listed in suggested sequence: | | Units |
|---|--|--------------|
| AC/R 100 C | Principles of Thermodynamics and Heat Transfer | 3 |
| AC/R 110 C | Air Conditioning I | 3 |
| AC/R 120 C | Piping Practice, Tools and Safety | 2 |
| AC/R 036 C | Refrigerants, Charging and Recovery | 1 |
| AC/R 137 C | Blueprints and Dimension Analysis | 2 |
| AC/R 105 C | Electricity for Air Conditioning and Refrigeration I | 3 |
| AC/R 115 C | Gas Heating and Carbon Monoxide | 2 |
| AC/R 125 C | Boiler and Hydronic Heating | 2 |
| AC/R 135 C | Solar Energy for Heat and Cool | 2 |
| AC/R 145 C | Load Calculations for Heating and Cooling | 2 |
| AC/R 205 C | Commercial Air Conditioning | 3 |
| Total Units Required | | 25 |

COMMERCIAL REFRIGERATION CERTIFICATE **Program Code: 1C31171**

The Commercial Refrigeration Certificate provides students with a career path for attaining the communication skills, practical knowledge, and technical training necessary for pursuing a career in Commercial Refrigeration. Students completing this certificate will develop an advanced understanding of commercial refrigeration.

To earn this certificate, complete the required courses as listed with a minimum grade of “C.” At least 50% of all major course work must be completed at Cypress College.

| Required courses are listed in suggested sequence: | | Units |
|---|---|----------------|
| AC/R 100 C | Principles of Thermodynamics and Heat Transfer | 3 |
| AC/R 120 C | Piping Practice, Tools and Safety | 2 |
| AC/R 036 C | Refrigerants, Charging and Recovery | 1 |
| AC/R 137 C | Blueprints and Dimension Analysis | 2 |
| AC/R 050 C | HVAC-R Special Projects | .5–1 |
| AC/R 105 C | Electricity for Air Conditioning and Refrigeration I | 3 |
| AC/R 106 C | Electricity for Air Conditioning and Refrigeration II | 3 |
| AC/R 135 C | Solar Energy for Heat and Cool | 2 |
| AC/R 145 C | Load Calculations for Heating and Cooling | 2 |
| AC/R 210 C | Commercial Refrigeration | 3 |
| Total Units Required | | 21.5–22 |

AIR CONDITIONING ENVIRONMENTAL CONTROLS CERTIFICATE

Program Code: 1C31189

The Controls and Energy Management Certificate provides students with a career path for attaining the communication skills, practical knowledge, and technical training necessary for pursuing a career in controls and energy management. Students completing this certificate will develop an advanced understanding of building controls and energy management.

To earn this certificate, complete the required courses as listed with a minimum grade of "C." At least 50% of all major course work must be completed at Cypress College.

| Required courses are listed in suggested sequence: | | Units |
|---|---|----------------|
| AC/R 100 C | Principles of Thermodynamics and Heat Transfer | 3 |
| AC/R 110 C | Air Conditioning I | 3 |
| AC/R 036 C | Refrigerants, Charging and Recovery | 1 |
| AC/R 137 C | Blueprints and Dimension Analysis | 2 |
| AC/R 050 C | HVAC-R Special Projects | .5-1 |
| AC/R 105 C | Electricity for Air Conditioning and Refrigeration I | 3 |
| AC/R 106 C | Electricity for Air Conditioning and Refrigeration II | 3 |
| AC/R 115 C | Gas Heating and Carbon Monoxide | 2 |
| AC/R 125 C | Boiler and Hydronic Heating | 2 |
| AC/R 135 C | Solar Energy for Heat and Cool | 2 |
| AC/R 145 C | Load Calculations for Heating and Cooling | 2 |
| AC/R 220 C | A/C Controls and Energy Management | 2 |
| Total Units Required | | 25.5-26 |

AIR CONDITIONING CUSTOMER SERVICE CERTIFICATE

Program Code: 1C31188

The Customer Service Certificate provides students with a career path for attaining the communication skills, practical knowledge, and technical training necessary for pursuing a career in customer service. Students completing this certificate will develop an advanced understanding of personal inter-relations of customer service.

To earn this certificate, complete the required courses as listed with a minimum grade of "C." At least 50% of all major course work must be completed at Cypress College.

| Required courses are listed in suggested sequence: | | Units |
|---|--|--------------|
| AC/R 100 C | Principles of Thermodynamics and Heat Transfer | 3 |
| AC/R 110 C | Air Conditioning I | 3 |
| AC/R 120 C | Piping Practice, Tools and Safety | 2 |
| AC/R 036 C | Refrigerants, Charging and Recovery | 1 |
| AC/R 137 C | Blueprints and Dimension Analysis | 2 |
| AC/R 105 C | Electricity for Air Conditioning and Refrigeration I | 3 |
| AC/R 115 C | Gas Heating and Carbon Monoxide | 2 |
| AC/R 125 C | Boiler and Hydronic Heating | 2 |
| AC/R 135 C | Solar Energy for Heat and Cool | 2 |
| AC/R 145 C | Load Calculations for Heating and Cooling | 2 |
| AC/R 055 C | Technician Customer Relations | 2 |
| Total Units Required | | 24 |

HEAT PUMP CERTIFICATE

Program Code: 1C31192

The Heat Pump Certificate provides students with a career path for attaining the communication skills, practical knowledge, and technical training necessary for pursuing a career in Heat Pump Technical Servicing. Students completing this certificate will develop an advanced understanding of heat pump systems.

To earn this certificate, complete the required courses as listed with a minimum grade of "C." At least 50% of all major course work must be completed at Cypress College.

| Required courses are listed in suggested sequence: | | Units |
|---|--|--------------|
| AC/R 100 C | Principles of Thermodynamics and Heat Transfer | 3 |
| AC/R 110 C | Air Conditioning I | 3 |
| AC/R 120 C | Piping Practice, Tools and Safety | 2 |
| AC/R 036 C | Refrigerants, Charging and Recovery | 1 |
| AC/R 137 C | Blueprints and Dimension Analysis | 2 |
| AC/R 105 C | Electricity for Air Conditioning and Refrigeration I | 3 |
| AC/R 115 C | Gas Heating and Carbon Monoxide | 2 |
| AC/R 125 C | Boiler and Hydronic Heating | 2 |
| AC/R 135 C | Solar Energy for Heat and Cool | 2 |
| AC/R 145 C | Load Calculations for Heating and Cooling | 2 |
| AC/R 230 C | Heat Pumps | 2 |
| Total Units Required | | 24 |

INDUSTRIAL TECHNOLOGY TRANSFER PROGRAM

AIR CONDITIONING SYSTEMS OPTION

Students should consult a counselor or www.assist.org for lower division major requirements for most California public universities. (See the Standard Definitions section of the catalog for a description of ASSIST.) Students transferring to an independent college/university should consult the catalog of the individual school and a counselor for lower division major requirements.

Air Conditioning and Refrigeration (AC/R)

AC/R 035 C Building Commissioning **2 Units**

Advisory: AC/R 105 C.

Term hours: 27 lecture and 27 laboratory. This course is designed to instruct the student in the verification of new construction, that all the subsystems for HVAC, Plumbing, Electrical, Building Envelopes, Interior Systems (example laboratory units), cogeneration, utility plants, sustainable systems, Lighting, Controls and provide sustainable life cost energy savings.

AC/R 036 C Refrigerants, Charging and Recovery **1 Unit**

Prerequisite: AC/R 100 C.

Term hours: 27 lecture and 27 laboratory. This course examines refrigerant classification, physical and chemical properties, lubricants, proper and safe handling, refrigerant systems evacuation, charging and recovery with classroom lecture, demonstration and laboratory exercises. Students may take an optional EPA refrigerant and R-410A certification exam.

AC/R 050 C HVAC/R Special Projects **.5 to 1 Units**

Prerequisite: AC/R 100 C or AC/R 105 C.

Term hours: 27-54 laboratory depending on units desired. This course is designed for students who have demonstrated interest and competencies for increased knowledge and experience in air conditioning and refrigeration technologies and applications not ordinarily covered in the curriculum. Students will participate in independent study and/or research on selected or assigned projects.

AC/R 055 C Technician Customer Relations 2 Units

Term hours: 27 lecture and 27 laboratory. This course provides guidelines and best practices for providing excellent field service customer relations that will enable front-line technicians and service staff in back-up and support roles to build, maintain, and increase a loyal customer base.

AC/R 100 C Principles of Thermodynamics and Heat Transfer 3 Units

Advisory: AC/R 120 C.

Term hours: 27 lecture and 81 laboratory. This course is a basic study of the theory of thermodynamics and heat transfer as applied to mechanical vapor compression refrigeration cycle and system components. Classes include lectures with practical demonstrations and hands-on experience including laboratory projects demonstrating heat transfer theories and vapor compression mechanical system cycle components and accessories. (CSU)

AC/R 105 C Electricity for Air Conditioning and Refrigeration I 3 Units

Term hours: 27 lecture and 81 laboratory. This course includes the basic electrical theory, concepts and principles as applied to air conditioning and refrigeration. Schematic reading and drawing, with laboratory project applications involving circuit wiring, the measurement of electrical quantities with electrical meters and electrical safety, will be presented. (CSU)

AC/R 106 C Electricity for Air Conditioning and Refrigeration II 3 Units

Prerequisite: AC/R 105 C with a minimum grade of "C".

Term hours: 27 lecture and 81 laboratory. This course is a continuation of Electricity for Air Conditioning and Refrigeration which builds upon the principles learned and applied. Course includes single phase, three phase electric motors and ECM motors, circuit board troubleshooting, overloads, pressure controls, time clocks and autotransformers with a lecture and laboratory practice exercises. (CSU)

AC/R 110 C Air Conditioning I 3 Units

Term hours: 27 lecture and 81 laboratory. This course is an introduction into comfort cooling and air conditioning applications with a study of the behavior of air vapor mixtures as applied to the psychrometric chart and related to the design of duct systems, emphasizing duct sizing, air distribution, fans and sheet metal techniques, as it relates to indoor air quality. (CSU)

AC/R 115 C Gas Heating and Carbon Monoxide 2 Units

Term hours: 27 lecture and 27 laboratory. This course is a basic study of gas heating systems which include the principles of fuel combustion, combustion analysis and forced warmer air heat. Carbon monoxide and the effects of incomplete combustion will be studied and analyzed. (CSU)

AC/R 120 C Piping Practice, Tools and Safety 2 Units

Advisory: AC/R 100 C.

Term hours: 27 lecture and 27 laboratory. This course includes laboratory projects and demonstrations involving design and construction of system piping, including techniques of shaping, forming, soldering, welding and the tools and safe practices required to design and construct refrigerant piping systems. \$36.00 Material Fee - Payable at Registration. (CSU)

AC/R 125 C Boiler and Hydronic Heating 2 Units

Term hours: 27 lecture and 27 laboratory. This course includes lectures and laboratory projects involving the design, assembly, and operation of hot water boilers, hot water piping distribution (hydronic), and associated controls and control valves. Included in the course content is the proper use of the related tools and safety. (CSU)

AC/R 135 C Solar Energy for Heat and Cool 2 Units

Term hours: 27 lecture and 27 laboratory. This course includes lectures and laboratory projects and demonstrations involving design, assembly and operation of solar energy systems. Included in this course content is theory and application of passive solar heating and cooling, solar energy systems using photo-voltaic arrays, thermal heating arrays, and new, cutting edge solar technologies. Also included is a through discussion of the various tools and safe practices associated with solar energy systems. (CSU)

AC/R 137 C Blueprints and Dimension Analysis 2 Units

Formerly AC/R 037 C

Advisory: AC/R 215 C.

Term hours: 27 lecture and 27 laboratory. This course covers the application of engineering calculations and the reading of blueprint plan sets as encountered by the air conditioning and refrigeration field technician, project manager and design engineer. Course includes practical application of numbers to the topics of problem solving, dimension conversion and mathematical verification, proportions and ratios, length measurements with field application and exercises, area calculations, duct and sheet metal calculations, and equivalent units of measurement. (CSU)

AC/R 140 C Plumbing Principles and Practices 4 Units

Term hours: 54 lecture and 54 laboratory. A course designed to instruct the student in the application of plumbing technology as is used in commercial building systems. Students will apply the theories and skills taught in the classroom on laboratory mock-ups simulating industry standards. (CSU)

AC/R 145 C Load Calculations for Heating and Cooling 2 Units

Prerequisite: AC/R 110 C with a minimum grade of "C".

Term hours: 27 lecture and 27 laboratory. This is an advanced air conditioning class in which the student will learn how to calculate the heating and cooling load of a building. The student will also create a computer spreadsheet to calculate the heat and cooling load. This course will also introduce the student to industry standards computer software that will calculate the heating and cooling load. (CSU)

AC/R 205 C Commercial Air Conditioning 3 Units

Prerequisite: AC/R 100 C and AC/R 105 C with minimum grades of "C".

Term hours: 27 lecture and 81 laboratory. This is an advanced course with emphasis on the air conditioning cycle. Pipe sizing, absorption systems, centrifugal & screw chillers, cooling towers, air handlers, and chilled water pumping. (CSU)

AC/R 210 C Commercial Refrigeration 3 Units

Prerequisite: AC/R 100 C and AC/R 105 C with minimum grades of "C".

Term hours: 27 lecture and 81 laboratory. This is an advanced course with emphasis on the refrigeration cycle. Pipe sizing, compressor sizing, h.p. requirements, single and two stage refrigeration systems and other advanced refrigeration systems will be included. (CSU)

AC/R 215 C Codes and Estimating for HVACR 3 Units

Advisory: AC/R 137 C.

Term hours: 27 lecture and 81 laboratory. This course is a lab class in which the student will develop a material and labor cost estimate and prepare construction bids for air conditioning systems. Building and mechanical codes and inspection procedures will be covered. Estimating processes by spreadsheet will be introduced. (CSU)

AC/R 220 C A/C Controls and Energy Management 2 Units

Advisory: AC/R 105 C.

Term hours: 27 lecture and 27 laboratory. A course designed to instruct the students in the application of air conditioning pneumatic and Direct Digital controls as is used in commercial building systems. Students will apply the theories and skills taught in the classroom on laboratory mock-ups simulating industry standards. (CSU)

AC/R 225 C Green A/C and Auditing 2 Units*Advisory: AC/R 100 C and AC/R 105 C.*

Term hours: 27 lecture and 27 laboratory. This course is designed to instruct the student in the design, application and maintenance of highly energy efficient (GREEN) air conditioning systems. Including topics on refrigerants, carbon footprint and efficient systems for commercial applications. (CSU)

AC/R 230 C Heat Pumps 2 Units*Prerequisite: AC/R 100 C and AC/R 105 C with minimum grades of "C".*

Term hours: 27 lecture and 27 laboratory. This course is designed to instruct the student in the application of heat pumps in commercial building systems. Students will apply the theories and skills taught in the classroom on laboratory mock-ups simulating industry standards. (CSU)

AC/R 235 C Air Conditioning Capstone 2 Units*Advisory: Completion of or concurrent enrollment in AC/R 137 C, AC/R 145 C, AC/R 205 C and AC/R 215 C.*

Term hours: 27 lecture and 27 laboratory. This course brings together all of the elements for the design, build and bid aspects of an air conditioning project application. (CSU)

AC/R 240 C Green Refrigeration and Auditing 2 Units*Advisory: AC/R 100 C and AC/R 105 C.*

Term hours: 27 lecture and 27 laboratory. This course is designed to instruct the student in the design, application and maintenance of highly energy efficient (GREEN) refrigeration systems. Including topics related to ammonia and carbon dioxide refrigeration systems for commercial applications. (CSU)

AC/R 260 C Crew Leadership-Field Supervisor  2 Units

Term hours: 36 hours lecture and 18 hours laboratory. Work crew leaders and field supervisors play major roles in every HVAC/R installation and construction project. This course is an overview of team building and the role of supervisor in a field environment. (CSU)

AC/R 265 C Project Management  3 Units*Prerequisite: Completion of or concurrent enrollment in CIS 216 C with minimum grade of "C".*

Term hours: 27 lecture and 27 laboratory. This course is designed to instruct the student in the design, application and maintenance of highly energy efficient (GREEN) refrigeration systems. Including topics related to ammonia and carbon dioxide refrigeration systems for commercial applications. (CSU)

AC/R 298 C Air Conditioning and Refrigeration Seminar .5 to 12 Units*Prerequisite: May be required.**Corequisite: May be required.**Advisory: May be required.*

Term hours: 0-12 lecture and/or 0-36 laboratory. This is a course for students who wish to increase their knowledge of air conditioning and refrigeration. Various topics will be offered. Unit credit may range from 1/2 to 12 units in any given semester. Consult the class schedule to verify credit for a particular semester. May be taken for credit 1-4 times. Pass/No Pass or Pass/No Pass/Letter Grade Option or Standard Letter Grade. Fees may be required - Payable at Registration. (CSU)

Anthropology

Division of Social Sciences

Division Dean — Lisa Gaetje, Interim*Faculty*

Becky Floyd

Craig Goralski

Counselors

Therese Mosqueda-Ponce

Daniel Pelletier

PROGRAM LEARNING OUTCOMES (PLOs)

The courses taught by this department contribute to the General Education and Basic Skills Program Learning Outcomes. Please refer to General Education and Basic Skills Program Learning Outcomes.

ASSOCIATE IN ARTS IN ANTHROPOLOGY FOR TRANSFER DEGREE (AA-T) Program Code: 1A32699

This curriculum is designed to provide an opportunity for the Anthropology major to achieve an Associate in Arts in Anthropology (AA-T in Anthropology) which completes the first and second year requirements for transfer to a four-year public California institution. This degree is designed to provide students with a comprehensive introduction to the four major fields of anthropology in order to give them the background knowledge needed by undergraduate anthropology majors. The course work emphasizes the practical applications of anthropological skills and knowledge in a diversity of careers and the utility of anthropological perspectives as a life-long learning tool for interpreting world events. Students successfully completing the AA-T in Anthropology will acquire a fundamental knowledge base of anthropology, learn basic knowledge and skills in data analysis and research methods, and possess a basic understanding of areas that have an interdisciplinary association to Anthropology. This degree will provide students with an introduction to the field including its scientific foundations and applied areas. While at least a baccalaureate degree is recommended preparation for those seeking professional careers, completion of this degree is excellent general preparation for careers in academic and applied anthropology, museums, contract archaeology, zoos, education, academic counseling, international business, corporations, research, translation, government, journalism and technical writing, non-profit organizations, and many other careers. It gives students a solid basis for many career paths and can be enhanced with multidisciplinary study in related fields. This curriculum specifically prepares the prospective transfer student for upper division course work in Anthropology or a similar major at a California State University (CSU) campus. At the baccalaureate level students can continue an education in various areas of anthropology including biological/physical anthropology, socio-cultural anthropology, archaeology and linguistic anthropology. Graduate study is important in Anthropology. Those holding a Master's or Doctoral degree may find employment in college and university teaching and other educational institutions such as museums and tribal relations, public and private research, ethnography, archaeology, primatology, museum curation, linguistics, forensic anthropology, and related fields. Those without a graduate degree will find limited career opportunity in direct areas of Anthropology. Students should consult a counselor, the Transfer Center and the catalog of the transfer-college or university to plan a specific program of study to meet the college or university's requirements.

Note: Courses that fulfill major requirements for an Associate Degree for Transfer at Cypress College might not be the same as those required for completing the major at all transfer institutions offering a Baccalaureate Degree. The Student Transfer Achievement Reform Act (Senate Bill 1440, now codified in California Education Code sections 66746–66749) guarantees admission to a California State University (CSU) campus for any community college student who completes an “associate degree for transfer,” a newly established variation of the associate degrees traditionally offered at a California community college. Students completing the AA-T are guaranteed admission to the CSU system, but not to a particular campus or major. Students transferring to a CSU campus that does accept the AA-T will be required to complete no more than 60 units after transfer to earn a bachelor’s degree (unless the major is designated “high-unit” major). This degree may not be the best option for students intending to transfer to a particular CSU campus or to a university or college that is not part of the CSU system.

To earn an AA-T in Anthropology students must complete: (1) a minimum of 19–21 semester or 28.5–31.5 quarter units in the Anthropology major with a minimum grade of “C”; (2) California State University General Education Breadth requirements (CSU GE Breadth) or the Intersegmental General Education Transfer Curriculum (CSU IGETC); (3) completion of 60 semester units of CSU transferable course work; and (4) have an overall GPA of 2.0.

| Required Core: 9 units | | Units |
|-------------------------------|---------------------------------------|--------------|
| ANTH 101 C | Biological Anthropology or | 3 |
| ANTH 101HC | Honors Biological Anthropology and | (3) |
| ANTH 102 C | Cultural Anthropology or | 3 |
| ANTH 102HC | Honors Cultural Anthropology and | (3) |
| ANTH 103 C | Introduction to Archaeology | 3 |

| List A — Select 4–5 units minimum from the following (ANTH 101LC plus one other): | | Units |
|--|---|--------------|
| ANTH 101LC | Biological Anthropology Lab and | 1 |
| ANTH 105 C | Introduction to Linguistic Anthropology or | 3 |
| ANTH 106 C | World Prehistory or | (3) |
| ANTH 107 C | Magic, Witchcraft and Religion or | (3) |
| ANTH 121 C | Native North America or | (3) |
| MATH 120 C | Introduction to Probability and Statistics or | (4) |
| PSY 161 C | Probability and Statistics-Social Sciences or | (4) |
| PSY 161HC | Honors Probability and Statistics- Social Sciences or | (4) |
| SOC 161 C | Probability and Statistics-Social Sciences or | (4) |
| SOC 161HC | Honors Probability and Statistics- Social Sciences | (4) |

List B — Select one (3–4 units) from List A courses not already taken. **Units**

| List C — Select 3 units minimum from List A courses not already taken, or from the following: | | Units |
|--|---|--------------|
| ANTH 104 C | Comparative Cultures or | 3 |
| ANTH 210 C | Introduction to Forensic Anthropology or | (3) |
| ANTH 225 C | Cultures of Mesoamerica or | (3) |
| ANTH 231 C | Field Course in Archaeology I | (3) |
| Total Units Required | | 19–21 |

ASSOCIATE IN ARTS DEGREE ANTHROPOLOGY Program Code: 1A18368

The Associate in Arts Degree in Anthropology is designed to provide students with a comprehensive introduction to the four major fields of anthropology in order to give them the background knowledge needed by undergraduate anthropology majors for university transfer and course work, while emphasizing the practical applications of anthropological skills and knowledge in a diversity of careers and the utility of anthropological perspectives as a life-long learning tool for interpreting world events.

To earn an Associate Degree students must complete: (1) all major course requirements with a minimum grade of “C”; (2) California State University General Education Breadth requirements (CSU GE Breadth) or IGETC general education plan; (3) any elective courses to complete a minimum of 60 units; (4) complete all graduation requirements; and (5) have an overall GPA of 2.0. At least 50% of all major course work must be completed at Cypress College. Students pursuing more than one specified departmental major may double count a maximum of 7 units to fulfill major requirements. Courses that fulfill major requirements for an Associate Degree at Cypress College might not be the same as those required for completing the major at a transfer institution offering a Baccalaureate Degree. For information on specific university requirements, please consult with your counselor, or visit the Transfer Center.

| Required Courses | | Units |
|-------------------------|---|--------------|
| ANTH 101 C | Biological Anthropology or | 3 |
| ANTH 101HC | Honors Biological Anthropology | (3) |
| ANTH 101LC | Biological Anthropology Lab | 1 |
| ANTH 102 C | Cultural Anthropology or | 3 |
| ANTH 102HC | Honors Cultural Anthropology | (3) |
| ANTH 106 C | World Prehistory or | 3 |
| ANTH 103 C | Introduction to Archaeology | (3) |
| ANTH 105 C | Introduction to Linguistic Anthropology | 3 |

| Six (6) units or more from the following Anthropology Elective Courses | | Units |
|---|---------------------------------------|--------------|
| ANTH 106 C | World Prehistory or | 3 |
| ANTH 103 C | Introduction to Archaeology | (3) |
| ANTH 104 C | Comparative Cultures | 3 |
| ANTH 107 C | Magic, Witchcraft and Religion | 3 |
| ANTH 121 C | Native North America | 3 |
| ANTH 210 C | Introduction to Forensic Anthropology | 3 |
| ANTH 225 C | Cultures of Mesoamerica | 3 |
| ANTH 231 C | Field Course in Archaeology I | 3 |
| Total Units Required | | 19 |

ANTHROPOLOGY TRANSFER PROGRAM

Students should consult a counselor or www.assist.org for lower division major requirements for most California public universities. (See the Standard Definitions section of the catalog for a description of ASSIST.) Students transferring to an independent college/university should consult the catalog of the individual school and a counselor for lower division major requirements.

Anthropology (ANTH)

ANTH 101 C Biological Anthropology 3 Units

Advisory: Eligibility for ENGL 100 C.

Term hours: 54 lecture. This course introduces the concepts, methods of inquiry, and scientific explanations for biological evolution and their application to the human species. Issues and topics will include, but are not limited to, genetics, evolutionary theory, human variation and biocultural adaptations, comparative primate anatomy and behavior, and the fossil evidence for human evolution. The scientific method serves as foundation of the course. Duplicate credit not granted for ANTH 101HC or ANTH 201 C. (UC Credit Limitation/CSU, AA GE, CSU GE, IGETC, C-ID: ANTH 110)

ANTH 101HC Honors Biological Anthropology 3 Units

Advisory: Eligibility for ENGL 100 C.

Term hours: 54 lecture. This course is an enhanced introduction to the concepts, methods of inquiry, and scientific explanations for biological evolution and their application to the human species. Issues and topics will include, but are not limited to, genetics, evolutionary theory, human variation and biocultural adaptations, comparative primate anatomy and behavior, and the fossil evidence for human evolution. The scientific method serves as foundation of the course. Duplicate Credit not granted for ANTH 101 C or ANTH 201 C. (UC Credit Limitation/CSU, AA GE, CSU GE, IGETC, C-ID: ANTH 110)

ANTH 101LC Biological Anthropology Lab 1 Unit

Prerequisite: Completion of or concurrent enrollment in ANTH 101 C or ANTH 101HC with minimum grades of "C".

Term hours: 54 lecture. This laboratory course is offered as a supplement to Biological Anthropology (ANTH 101 C/101HC) either taken concurrently or in a subsequent term. It provides an introduction to experiential and experimental laboratory research methods used in biological anthropology. Laboratory exercises are designed to introduce students to the scientific method and explore genetics, the forces of evolution, human variation, human osteology, human and non-human primate anatomy and behavior, the primate and hominid/hominin fossil record and other resources to investigate processes that affect human evolution. One field trip to a regional zoo will be required for non-human primate observations. Zoo admissions range \$10.00 - \$45.00. (UC/CSU, AA GE, CSU GE, IGETC)

ANTH 102 C Cultural Anthropology 3 Units

Advisory: Eligibility for ENGL 100 C.

Term hours: 54 lecture. This course explores how anthropologists study and compare human culture. Cultural anthropologists seek to understand the diversity of human experience focusing on a set of central issues: how people around the world make their living (subsistence patterns); how they organize themselves socially, politically and economically; how they communicate; how they relate to each other through marriage, family and kinship ties; what they believe about the world (religion and belief systems); how they express themselves creatively (the arts and expressive culture); how they make distinctions among themselves; how they have shaped and been shaped by the past; and how they navigate culture change and processes of globalization. Ethnographic case studies highlight these similarities and differences, and introduce students to how anthropologists do their work, employ professional anthropological research ethics and apply their perspectives and skills to understand humans around the globe. (UC/CSU, AA GE, CSU GE, IGETC, C-ID: ANTH 120)

ANTH 102HC Honors Cultural Anthropology 3 Units

Advisory: Eligibility for ENGL 100 C.

Term hours: 54 lecture. This course is an enhanced exploration of how anthropologists study and compare human culture. Cultural anthropologists seek to understand the diversity of human experience focusing on a set of central issues: how people around the world make their living (subsistence patterns); how they organize themselves socially, politically and economically; how they communicate; how they relate to each other through marriage, family and kinship ties; what they believe about the world (religion and belief systems); how they express themselves creatively (the arts and expressive culture); how they make distinctions among themselves; how they have shaped and been shaped by the past; and how they navigate culture change and processes of globalization. Ethnographic case studies highlight these similarities and differences, and introduce students to how anthropologists do their work, employ professional anthropological research ethics and apply their perspectives and skills to understand humans around the globe. Duplicate credit not granted for ANTH 102 C. (UC/CSU, AA GE, CSU GE, IGETC, C-ID: ANTH 120)

ANTH 103 C Introduction to Archaeology 3 Units

Advisory: Eligibility for ENGL 100 C.

Term hours: 54 lecture. This course is an introduction to the study of concepts, theories, data and models of anthropological archaeology that contribute to our knowledge of the human past. The course includes a discussion of the nature of scientific inquiry; the history and interdisciplinary nature of archaeological research; dating techniques; methods of survey, excavation, analysis, and interpretation; cultural resource management; professional ethics; and selected cultural sequences. (UC/CSU, AA GE, CSU GE, IGETC, C-ID: ANTH 150)

ANTH 104 C Comparative Cultures 3 Units

Advisory: Eligibility for ENGL 100 C.

Term hours: 54 lecture. This course uses a focused cross-cultural and comparative approach to introduce anthropological concepts such as modes of production, family and kinship, economics, political organization, art and religion. Globalization and culture change will also be explored. A representative selection of culture areas will be featured through ethnography, providing perspective on the variety of human adaptation and how cultural systems are integrated. (UC/CSU, CSU GE, IGETC)

ANTH 105 C Introduction to Linguistic Anthropology 3 Units

Advisory: Eligibility for ENGL 100 C.

Term hours: 54 lecture. This course is an introduction to anthropological linguistics, exploring the nature of language in relation to culture and how language processes develop and change. Students will examine how cultural knowledge is linguistically organized and how language shapes our perception of the world, and how it acts as a guide, both symbolic and practical, to understanding human thoughts and behaviors. An introduction to descriptive linguistics is also provided. (UC/CSU, AA GE, CSU GE, IGETC, C-ID: ANTH 130)

ANTH 106 C Human Prehistory and Ancient Civilizations 3 Units

Advisory: Eligibility for ENGL 100 C.

Term hours: 54 lecture. This course is an introduction to the prehistoric development of civilizations both in the Old World and the New World beginning with early modern humans. Because the prehistoric is the time prior to cultures' writing about themselves, students will examine archaeological methods and theories used to describe the past. Topics will include the spread of modern humans, Mesolithic societies, the origins of food production and the evolution and collapse of various world civilizations. (UC/CSU, AA GE, CSU GE, IGETC)

ANTH 107 C Magic, Witchcraft and Religion 3 Units*Advisory: Eligibility for ENGL 100 C.*

Term hours: 54 lecture. This course is an introduction to the anthropology of religion. It will explore the beliefs and practices of numerous world cultures, particularly, but not exclusively, focusing on non-Western traditional societies, using a cross-cultural approach. Anthropological perspectives on the study of religion, mythology and symbolism will be discussed. Ritual, magic, divination, shamanism, sorcery, altered states of consciousness, healing, witchcraft, syncretism and new religious movements, among other related topics, will be analyzed with respect to the functions they have and how religion as a cultural institution is integrated into society in general and in the life of the individual. (UC/CSU, AA GE, CSU GE, IGETC)

ANTH 121 C Native North America 3 Units*Advisory: Eligibility for ENGL 100 C.*

Term hours: 54 lecture. This course is an anthropological survey of the cultures of Native American societies of North America. Topics include the peopling of the New World, traditional culture, the impacts of culture contact both from Western cultures and native peoples' cultures on one another, and contemporary issues. (UC/CSU, CSU GE, IGETC, CUL DIV)

ANTH 208 C Anthropology of Death 3 Units*Advisory: ENGL 100 C.*

Term hours: 54 lecture. This course is a cross-cultural exploration of the beliefs and practices surrounding death, dying, mourning, and mortuary customs, as well as conceptions of the afterlife, in cultures around the world. An integrated anthropological approach will be taken, including data from archaeology, biological anthropology and cultural anthropology. (UC/CSU - pending, AA GE - pending, CSU GE - pending, IGETC - pending)

ANTH 210 C Introduction to Forensic Anthropology 3 Units*Advisory: Eligibility for ENGL 100 C; prior learning of the skeletal system or human osteology.*

Term hours: 54 lecture. Forensic anthropology is the application of standard, scientific, anthropological methods and techniques to identify human remains and to assist in the detection of a crime or after a mass disaster. This course provides a basic overview of the field of forensic anthropology, human osteology, the techniques used to make estimations of age, sex, ancestry and stature, recovery techniques and the analytic techniques and procedures used in the medico-legal framework. This class includes extensive analysis of anthropological methods, ethics, socio-cultural considerations and civic responsibilities inherent to forensic anthropology. (UC/CSU, AA GE)

ANTH 211 C Applied and Practicing Anthropology 3 Units*Advisory: Eligibility for ENGL 100 C.*

Term hours: 54 lecture. Applied anthropology focuses on the use of anthropological theories and perspectives in real-world contexts of practice or problem-solving. The course will provide students with tools designed to help understand and solve problems arising as a result of culture change, modernization and globalization. The major arenas of study will include development anthropology and the use of technology in field settings, anthropology and healthcare, anthropology and advocacy, such as in social work settings, anthropology and law, organizational and business anthropology, and land and resource management. Careers in applied and practicing anthropology across the subfields will be explored. An applied research project and/or fieldtrips may be required. (proposed: AA GE, CSU GE, IGETC)

ANTH 225 C Ancient Cultures of Mexico and Central America 3 Units*Advisory: Eligibility for ENGL 100 C.*

Term hours: 54 lecture. This course explores the diverse cultures of ancient Mesoamerica from the origins of civilization through the initial period of Spanish contact. Mesoamerica is defined as the culture area extending from the Rio Grande to the north to the Isthmus of Panama to the south. While the contributions of all four fields of anthropology will be explored, this course will primarily approach the cultures of Mesoamerica from archaeological and ethnohistoric perspectives. The subsistence practices, social organization and ideologies of past cultures will be presented and links between these ancient lifeways and aspects of the modern cultures of northern Latin America will be discussed. (UC/CSU, CSU GE, IGETC)

ANTH 231 C Field Course in Archaeology I 3 Units*Advisory: ANTH 103 C.*

Term hours: 18 lecture and 108 laboratory. This course provides practical experience in field archaeology through a combination of lectures and laboratory hours in a fieldwork setting. It is designed to provide an introductory understanding of site survey, archaeological methods, laboratory analysis, local prehistory and museum preparation. (CSU)

ANTH 232 C Field Course in Archaeology II 3 Units*Prerequisite: ANTH 231 C with a minimum grade of "C".**Advisory: ANTH 103 C.*

Term hours: 18 lecture and 108 laboratory. This course provides intermediate level practical experience in field archaeology. Students will be expected to build on the skills introduced in ANTH 231 C through a combination of lectures and laboratory hours in a fieldwork setting. This class provides a more advanced understanding of site survey, archaeological methods, laboratory analysis, local prehistory and museum preparation, with an emphasis on the curation and analysis of specific artifact types. Students are also expected to mentor students in the co-occurring ANTH 231 C in the field by modeling introductory skills in a field setting. Completion of ANTH 232 C is intended to prepare students for entry-level positions in Cultural Resource Management. (CSU)

ANTH 298 C Anthropology Seminar .5 to 12 Units*Prerequisite: May be required.**Corequisite: May be required.**Advisory: May be required.*

Term hours: 0-12 lecture and 0-36 laboratory. This is a lecture/discussion type course developed on a particular limited problem or topic of interest to students. It is designed for able students who wish to increase their knowledge on a particular topic concerning which no other regular class is offered. A paper or group activity may be requested. Credit may range from 1/2 to 12 units. Consult the class schedule for the offerings in a particular semester. May be taken for credit 1-4 times. Pass/No Pass or Pass/No Pass/Letter Grade Option or Standard Letter Grade. Fees may be required-Payable at Registration. (UC Credit Limitation/CSU)

ANTH 299 C Anthropology Independent Study**1 Unit***Prerequisite: Approved Independent Study Learning Contract.*

May be taken for credit 3 times.

Term hours: Varying hours of scheduled conferences per week. Independent study is for able students who wish to extend their knowledge of a particular area through individual research and study. It is thought that topics might develop out of a curiosity stimulated in a regular class. The student would then contact the supervising instructor to develop a contract for his/her particular interest so that they could learn more regarding their special topic. (UC Credit Limitation/CSU)

ANTH 308 C Anthropology of Death for Mortuary Science**3 Units***Prerequisite: Completion of ENGL 100 C or ENGL 100HC with a grade of "C" or better.**Advisory: Completion of ANTH 102 C or 104 C or 107 C.*

Term hours: 54 lecture. This is an upper division intensive writing course intended only for Cypress College's Bachelor of Science in Funeral Service students. (All other students interested in this course should take ANTH 208 C - Anthropology of Death). This course is a cross-cultural exploration of the beliefs and practices surrounding death, dying, mourning, and mortuary customs, as well as conceptions of the afterlife, in cultures around the world. An integrated anthropological approach will be taken, including data from archaeology, biological anthropology and cultural anthropology. Enrollment is limited to those accepted into the Funeral Service Bachelor of Science degree program. Duplicate credit not granted for ANTH 208 C.

Art

Division of Fine Arts

Division Dean — Katy Realista*Faculty*

Edward Giardina

Ian Holmes

Janet Owens

Paul Paiement

Joyce Patti

Molly Schulps

Counselors

Renay Laguana-Ferinac

Renee Ssensalo

PROGRAM LEARNING OUTCOMES (PLOs)

Art Department

- Given art materials, students will be able to show their knowledge of various art processes, theory, and technical skills.
- Given art materials, students will be able to effectively communicate content through the principles and elements of design.
- Given art works and materials, students will be able to critically analyze the principles and elements of design for content and historical importance.
- Students will develop artistic skills to visually articulate and comprehend the interconnection between art and culture.

Course Repeatability Limitations

Effective 2013, most active participatory courses in Art, Dance, Theater, Music, and Kinesiology are no longer repeatable. The courses in the table below are related in content and therefore have been identified in distinct "family" groupings in which students are limited to a maximum of 4 course enrollments per family (withdrawals and substandard grades will be counted towards the 4 enrollment maximum). Note: Exceptions for courses still designated as repeatable are indicated in course descriptions of the college catalog and class schedules with the statement, "May be taken for credit ___ times." If students are majoring in any of these disciplines, they are advised to see their counselor to discuss options.

| | | | |
|-----------------------|-----------------|--|--|
| Art | Ceramics | ART 150 C, 151 C, 152 C, 153 C, 154 C | Students are limited to four (4) semester enrollments — in Active Participatory courses — whether in a single course or in a combination of courses grouped within a family. All enrollments in courses (including enrollments in the same repeatable course) within a family count toward the maximum enrollment limitation of four (4) semester enrollments. This includes evaluative (A, B, C, D, F, P, NP) and non-evaluative (I, IP, RD, and W) grades earned. All letter grades received will be counted in GPA. |
| | Design | ART 120 C, 121 C, 123 C, 140 C, 141 C, 142 C | |
| | Drawing | ART 182 C, 183 C, 184 C, 185 C, 186 C | |
| | Gallery Studies | ART 161 C, 162 C, 163 C | |
| | Illustration | ART 244 C, 246 C | |
| | Jewelry | ART 174 C, 175 C | |
| | Painting | ART 191 C, 193 C, 194 C, 195 C, 196 C | |
| | Printmaking | ART 130 C, 131 C | |
| Art Exceptions | None | | |

**ASSOCIATE IN ARTS IN
ART HISTORY FOR TRANSFER
DEGREE (AA-T)**

Program Code: 1A31986

This curriculum is designed to provide an opportunity for the Art History major to achieve an Associate in Arts Degree in Art History for Transfer (AA-T in Art History) which completes the first and second year requirements for transfer to a four-year public California institution. This degree provides lower division major and general education preparation for students interested in transferring to four-year universities as Art History majors. The study of Art History is an interdisciplinary, critical study of human history through the perspective of visual culture. Students explore the various areas of Art History to build a foundation for future creative, interpretive, analytical work. While at least a baccalaureate degree is recommended preparation for those considering professional careers, completion of this curriculum will demonstrate commitment to the field and provide comprehensive preparation for further academic study through upper-division course work. This curriculum specifically prepares the prospective transfer student for upper division course work in Art History or a similar major at a California State University (CSU) campus. Students should consult a counselor, the Transfer Center and the catalog of the transfer college or university to plan a specific program of study to meet the college or university's requirements.

Note: Courses that fulfill major requirements for an Associate Degree for Transfer at Cypress College might not be the same as those required for completing the major at all transfer institutions offering a Baccalaureate Degree. The Student Transfer Achievement Reform Act (Senate Bill 1440, now codified in California Education Code sections 66746–66749) guarantees admission to a California State University (CSU) campus for any community college student who completes an “associate degree for transfer,” a newly established variation of the associate degrees traditionally offered at a California community college. The AA-T is intended for students who plan to complete a bachelor's degree in a similar major at a CSU campus. Students completing these degrees (AA-T) are guaranteed admission to the CSU system, but not to a particular campus or major. Students transferring to a CSU campus that does accept the AA-T will be required to complete no more than 60 units after transfer to earn a bachelor's degree (unless the major is designated “high-unit” major). This degree may not be the best option for students intending to transfer to a particular CSU campus or to a university or college that is not part of the CSU system. Students should consult with a counselor when planning to complete the degree for more information on university admission and transfer requirements.

To earn an AA-T in Art History students must complete the following requirements: (1) a minimum of 18–20 semester units or 27–30 quarter units in the Art History major with a minimum grade of “C”; (2) California State University General Education Breadth requirements (CSU GE Breadth) or the Intersegmental General Education Transfer Curriculum (CSU IGETC); (3) completion of 60 semester or 90 quarter units of CSU transferable course work; and (4) have an overall GPA of 2.0.

| Required Core: 9 Units | | Units |
|-------------------------------|---------------------------------|--------------|
| ART 111 C | Survey of Art History I | 3 |
| ART 112 C | Survey of Art History II | 3 |
| | or | |
| ART 112HC | Honors Survey of Art History II | (3) |
| ART 182 C | Beginning Drawing | 3 |

| List A | | Units |
|--|----------------------------------|--------------|
| ART 216 C | Latin American Art | 3 |
| List B — select 1 course from the following courses listed: | | |
| ART 120 C | Two-Dimensional Design | 3 |
| ART 121 C | Three-Dimensional Design | 3 |
| ART 185 C | Beginning Life Drawing | 3 |
| ART 140 C | Graphic Design 1 | 3 |
| ART 150 C | Ceramics Handbuilding | 3 |
| PHOT 101 C | Introduction to Photography | 3 |
| List C — select 1 course from the following courses listed or any course from List B not already used | | |
| ART 114 C | Modern Art History | 3 |
| ART 100 C | Fundamentals of Art | (3) |
| ART 110 C | Introduction to Art | (3) |
| ENGL 110 C | Humanities: Ancient and Medieval | (3) |
| ENGL 111 C | Humanities: Renaissance–Present | (3) |
| FREN 101 C | Elementary French I | (5) |
| FREN 102 C | Elementary French II | (5) |
| FREN 203 C | Intermediate French III | (4) |
| FREN 204 C | Intermediate French IV | (4) |
| HIST 110 C | Western Civilizations I | (3) |
| | or | |
| HIST 110HC | Honors West. Civilizations I | (3) |
| HIST 111 C | Western Civilizations II | (3) |
| | or | |
| HIST 111HC | Honors West. Civilizations II | (3) |
| HIST 112 C | World Civilizations I | (3) |
| | or | |
| HIST 112HC | Honors World Civilizations I | (3) |
| HIST 113 C | World Civilizations II | (3) |
| | or | |
| HIST 113HC | Honors World Civilizations II | (3) |
| INDS 101 C | Humanities: Renaissance–Present | (3) |
| INDS 100 C | Humanities: Ancient and Medieval | (3) |
| PHIL 201 C | History of Ancient Philosophy | (3) |
| PHIL 202 C | History of Modern Philosophy | (3) |
| Total Units Required | | 18–20 |

**ASSOCIATE IN ARTS IN
STUDIO ARTS FOR TRANSFER
DEGREE (AA-T)**

Program Code: 1A32097

This curriculum is designed to provide an opportunity for the Studio Arts Degree major to achieve an Associate in Arts in Studio Arts for Transfer (AA-T in Studio Arts) which completes the first and second year requirements for transfer to a four-year public California institution. This degree provides lower division major and general education preparation for students interested in transferring to four-year universities as Studio Arts majors. The study of Studio Arts is an interdisciplinary, critical study of technical development, as well as the foundation for all studio based courses. Students explore the various areas of studio art to build a foundation for future creative, interpretive, analytical work and portfolios. While at least a baccalaureate degree is recommended preparation for those considering professional careers, completion of this curriculum will demonstrate commitment to the field and provide comprehensive preparation for further academic study through upper-division course work. This curriculum specifically prepares the prospective transfer student for upper division course work in Studio Arts or a similar major at a California State University (CSU) campus. Students should consult a counselor, the Transfer Center and the catalog of the college or university to plan a specific program of study to meet the college or university's requirements.

Note: Courses that fulfill major requirements for an Associate Degree for Transfer at Cypress College might not be the same as those required for completing the major at all transfer institutions offering a Baccalaureate Degree. The Student Transfer Achievement Reform Act (Senate Bill 1440, now codified in California Education Code sections 66746–66749) guarantees admission to a California State University (CSU) campus for any community college student who completes an “associate degree for transfer,” a newly established variation of the associate degrees traditionally offered at a California community college. The AA-T is intended for students who plan to complete a bachelor’s degree in a similar major at a CSU campus. Students completing these degrees (AA-T) are guaranteed admission to the CSU system, but not to a particular campus or major. Students transferring to a CSU campus that does accept the AA-T will be required to complete no more than 60 units after transfer to earn a bachelor’s degree (unless the major is designated “high-unit” major). This degree may not be the best option for students intending to transfer to a particular CSU campus or to a university or college that is not part of the CSU system. Students should consult with a counselor when planning to complete the degree for more information on university admission and transfer requirements.

To earn an AA-T in Studio Arts, students must complete the following requirements: (1) a minimum of 24–25 semester units or 36–37.5 quarter units in the Studio Arts major with a minimum grade of “C”; (2) California State University General Education Breadth requirements (CSU GE Breadth) or the Intersegmental General Education Transfer Curriculum (CSU IGETC); (3) completion of 60 semester or 90 quarter units of CSU transferable course work; and (4) have an overall GPA of 2.0.

| Core Courses (12 units) | | Units |
|--------------------------------|---------------------------------|--------------|
| ART 112 C | Survey of Art History II or | 3 |
| ART 112HC | Honors Survey of Art History II | (3) |
| ART 120 C | Two-Dimensional Design | 3 |
| ART 121 C | Three-Dimensional Design | 3 |
| ART 182 C | Beginning Drawing | 3 |

List A: Art History restricted Electives (3)

| Select one course from the following: | | Units |
|--|-------------------------|--------------|
| ART 111 C | Survey of Art History I | 3 |
| ART 114 C | Modern Art History | 3 |

List B: Studio Arts restricted Electives (9)

| Select three courses from the following: | | Units |
|---|---------------------------------------|--------------|
| ART 185 C | Beginning Life Drawing | 3 |
| ART 130 C | Introduction to Printmaking | 3 |
| ART 150 C | Ceramics Handbuilding | 3 |
| ART 151 C | Ceramics Throwing | 3 |
| MAD 100 C | Introduction to Computer Graphics/Mac | 3 |
| PHOT 101 C | Introduction to Photography | 3 |
| ART 123 C | Color Theory | 3 |
| ART 174 C | Jewelry Design and | 3 |
| ART 175 C | Metalsmithing | 3 |
| ART 140 C | Graphic Design 1 | 3 |
| ART 183 C | Intermediate Drawing | 3 |
| Total Units Required | | 24 |

ASSOCIATE IN ARTS DEGREE

GRAPHIC DESIGN

Program Code 1A10448

The primary emphasis is to prepare the student for employment. To earn an Associate Degree students must complete: (1) all major course requirements with a minimum grade of “C”; (2) 25 units of General Education Graduation Requirements; (3) the cultural diversity and reading requirements; (4) any elective courses to complete a minimum of 60 units; and, (5) have a minimum GPA of 2.0. At least 50% of all major course work must be completed at Cypress College.

Courses that fulfill major requirements for an Associate Degree at Cypress College might not be the same as those required for completing the major at a transfer institution offering a Baccalaureate Degree. For information on specific university requirements, please consult with your counselor, or visit the Transfer Center.

| Required courses are listed in suggested sequence: | | Units |
|---|---|--------------|
| *ART 182 C | Beginning Drawing | 3 |
| ART 110 C | Introduction to Art or | 3 |
| ART 100 C | Fundamentals of Art | (3) |
| ART 120 C | Two-Dimensional Design | 3 |
| ART 185 C | Beginning Life Drawing | 3 |
| MAD 140 C | DeskTop Publishing 1/Mac | 3 |
| ART 140 C | Graphic Design 1 | 3 |
| MAD 144 C | Graphic Design 2 | 3 |
| MAD 145 C | Graphic Design 3 | 3 |
| MAD 112 C | Electronic Illustration/Mac or | 3 |
| MAD 113 C | Electronic Illustration/Win | (3) |
| ART 244 C | Illustration | 3 |
| **ART 111 C | Survey of Art History I | 3 |
| **ART 112 C | Survey of Art History II | 3 |
| MAD 100 C | Introduction to Computer Graphics-Mac or | 3 |
| MAD 101 C | Introduction to Computer Graphics-Win | (3) |

Electives

Select a minimum of 9 units from the elective courses listed below

| | Units | |
|------------|-----------------------------|---|
| ART 130 C | Introduction to Printmaking | 3 |
| PHOT 101 C | Introduction to Photography | 3 |
| MKT 103 C | Principles of Advertising | 3 |
| MAD 190 C | Contemporary Art Studio | 3 |
| ART 166 C | Contemporary Art Studio | 3 |

Total Units Required **48**

*A score of 3 or higher on the Advanced Placement (AP) Art (Studio Drawing) exam with portfolio approval, meets this requirement upon petition through Admissions and Records. See a counselor for more information.

**A score of 3 or higher on the Advanced Placement (AP) Art (History) exam meets this requirement upon petition through Admissions and Records. See a counselor for more information.

ASSOCIATE IN ARTS DEGREE

ART

Program Code: 1A03776

This program is designed to prepare the student in the development of conceptual and technical skills required by artists in certain occupations.

To earn an Associate Degree students must complete: (1) all major course requirements with a minimum grade of “C”; (2) 25 units of General Education Graduation Requirements; (3) the cultural diversity and reading requirements; (4) any elective courses to complete a minimum of 60 units; and, (5) have a minimum GPA of 2.0. At least 50% of all major course work must be completed at Cypress College.

Courses that fulfill major requirements for an Associate Degree at Cypress College might not be the same as those required for completing the major at a transfer institution offering a Baccalaureate Degree. For information on specific university requirements, please consult with your counselor, or visit the Transfer Center.

Required Courses are listed in suggested sequence:

| Course # | Title | Units |
|-----------|------------------------------|-------|
| ART 182 C | Beginning Drawing | 3 |
| ART 120 C | Two-Dimensional Design | 3 |
| ART 111 C | Survey of Art History I | 3 |
| ART 112 C | Survey of Art History II | 3 |
| | or | |
| ART 112HC | Honors Survey Art History II | (3) |
| ART 121 C | Three-Dimensional Design | 3 |
| ART 123 C | Color Theory | 3 |

Select at least 15 units from the following:

| Course # | Title | Units |
|-----------------------------|---------------------------------|-----------|
| ART 130 C | Introduction to Printmaking | 3 |
| ART 131 C | Intermediate Printmaking | 3 |
| ART 150 C | Ceramics Handbuilding | 3 |
| ART 151 C | Ceramics Throwing | 3 |
| ART 152 C | Technical/Conceptual Ceramics | 3 |
| ART 153 C | Ceramic Studio Exploration | 3 |
| ART 154 C | Ceramic Aesthetics and Finishes | 3 |
| ART 161 C | Gallery Studies 1 | 3 |
| ART 162 C | Gallery Studies 2 | 3 |
| ART 163 C | Gallery Studies 3 | 3 |
| ART 183 C | Intermediate Drawing | 3 |
| ART 184 C | Advanced Drawing | 3 |
| ART 185 C | Beginning Life Drawing | 3 |
| ART 186 C | Intermediate Life Drawing | 3 |
| ART 191 C | Life Painting | 3 |
| ART 193 C | Portrait Painting | 3 |
| ART 194 C | Beginning Painting | 3 |
| ART 195 C | Intermediate Painting | 3 |
| ART 196 C | Advanced Painting | 3 |
| ART 244 C | Illustration | 3 |
| ART 246 C | Advanced Illustration | 3 |
| Total Units Required | | 33 |

ART TRANSFER PROGRAM

Students should consult a counselor or www.assist.org for lower division major requirements for most California public universities. (See the Standard Definitions section of the catalog for a description of ASSIST.) Students transferring to an independent college/university should consult the catalog of the individual school and a counselor for lower division major requirements.

Art (ART)

ART 100 C Fundamentals of Art

3 Units

Term hours: 54 lecture. This introductory course investigates the visual elements and principles of art through lectures, reading, films and hands-on experience. It also examines, in the same manner, historical styles and themes in art as well as materials and techniques. Pass/No Pass/Letter Grade Option. Cost of museum visit and materials will not exceed \$20.00. (UC/CSU, AA GE, CSU GE, IGETC)

ART 110 C Introduction to Art

3 Units

Advisory: Completion of ENGL 100 C.

Term hours: 54 lecture. This course is designed to expose the student to art from prehistoric times to the present: its purposes, materials, themes, history, and significance. It also acquaints the student with art and artists' roles in present and past societies, and helps the student understand the uses of materials and visual elements (i.e., line, color, etc.) to communicate ideas in architecture, sculpture, painting, ceramics, crafts, filmmaking, printmaking, etc. Major writing assignments are required. Pass/No Pass/Letter Grade Option. Cost of museum visit will not exceed \$15.00. (UC/CSU, AA GE, CSU GE, IGETC, C-ID: ARTH 100)

ART 111 C Survey of Art History I

3 Units

Advisory: Completion of ENGL 100 C.

Term hours: 54 lecture. This course studies the development of ancient and medieval architecture, sculpture and painting in the Western and Eastern cultures. Emphasis is placed on examining how art records and shapes history, how style communicates the ideas of the artist and his culture, and how symbols, techniques, materials and subjects are used and transferred from one culture to another. Major writing assignments are required. Pass/No Pass/Letter Grade Option. Cost of museum visit will not exceed \$15.00. (UC/CSU, AA GE, CSU GE, IGETC, C-ID: ARTH 110)

ART 112 C Survey of Art History II

3 Units

Advisory: Completion of ENGL 100 C.

Term hours: 54 lecture. This course studies the development of architecture, sculpture and painting in the Western world from the Renaissance through the twenty-first century. Emphasis is placed on examining how art records and shapes history, how style communicates the ideas of the artist and his culture, and how symbols, techniques, materials and subjects are used and transferred from one culture to another. Major writing assignments are required. Cost of museum visit will not exceed \$15.00. Duplicate credit not granted for ART 112HC. Pass/No Pass/Letter Grade Option. (UC Credit Limitation/CSU, AA GE, CSU GE, IGETC, C-ID: ARTH 120)

ART 112HC Honors Survey of Art History II

3 Units

Advisory: Completion of ENGL 100 C.

Term hours: 54 lecture. This is an enhanced course that studies the development of architecture, sculpture, and painting of the Western world from the Renaissance through the twenty-first century. Emphasis is placed on examining how art records and shapes history, how style communicates the ideas of the artist and his culture, and how symbols, techniques, materials, and subjects are used and transferred from one culture to another. Cost of museum visit will not exceed \$15.00. Duplicate credit not granted for ART 112 C. (UC Credit Limitation/CSU, AA GE, CSU GE, IGETC, C-ID: ARTH 120)

ART 114 C Modern Art History

3 Units

Advisory: Completion of ENGL 100 C.

Term hours: 54 lecture. This course deals with the nature of twentieth and twenty-first century art and its origins in the late nineteenth century. Emphasis is placed on examining how art reflects history, how style communicates the ideas of the artist and his/her culture and how symbols, techniques, materials and subjects are used and expanded in 20th and 21st century artistic expression. Major written assignments are required. Cost of museum visit will not exceed \$15.00. Pass/No Pass/Letter Grade Option. (UC/CSU, AA GE, CSU GE, IGETC)

ART 120 C Two-Dimensional Design**3 Units**

Term hours: 36 lecture and 72 laboratory. This course provides the foundation for all visual arts, by examining the concepts, terminology, techniques and materials used in two-dimensional design. Materials fees are used for materials provided by the Art Department. \$25.00 Material Fee - Payable at Registration. (UC/CSU, AA GE, CSU GE, C-ID: ARTS 100)

ART 121 C Three-Dimensional Design**3 Units**

Term hours: 36 lecture and 72 laboratory. This course is an introductory course covering the materials, techniques, and tools used to create three-dimensional forms. This course emphasizes the vocabulary of three-dimensional design and its application to problem solving in three-dimensions. \$20.00 fee for materials used in common-Payable at Registration. (UC/CSU, C-ID: ARTS 101)

ART 123 C Color Theory**3 Units**

Term hours: 36 lecture and 72 laboratory. This course focuses on the visual and conceptual interactions of color pertaining to painting, drawing, photography, media arts and design. Utilizes the historical theories of color by previous artists to study distinct color properties and functions. This class investigates color symbolism and composition through isolation and reintegration of the elements of color theory. Combines lecture, demonstration and critique with hands-on exploration in problem solving. \$25.00 Material Fee - Payable at Registration. Materials include paint and collage. (UC/CSU, C-ID: ARTS 270)

ART 130 C Introduction to Printmaking**3 Units**

Term hours: 36 lecture and 72 laboratory. This course will present the artist with concepts and techniques of drawing, design, and color through the use of fine art printing medias such as etching, lithography, and woodcut. \$10.00 Material Fee-Payable at Registration. (UC/CSU)

ART 131 C Intermediate Printmaking**3 Units**

Prerequisite: ART 130 C with a minimum grade of "C".
Term hours: 36 lecture and 72 laboratory. This intermediate course will continue with exploration and technical problem solving in fine art printing medias such as etching, lithography, screen printing and woodcut. (CSU) \$10.00 Materials Fee - Payable at Registration. (UC/CSU)

ART 144 C Cartooning**3 Units**

Term hours: 36 lecture and 72 laboratory. This course is an introduction to basic cartooning techniques which includes sketching, inking, and the development of characters. Projects include gag-line cartooning, political cartooning, and the development of a weekly cartoon strip. In addition, there will be an analysis of the elements of both the humorous and the dramatic in cartoon art. This analysis will include a review of historically significant Sunday funnies and comic book characters, an examination of major trends in comic art from 1895 to the present and fundamentals of storyboard development. May be taken for credit 3 times. (CSU)

ART 149 C Beginning Sculpture**3 Units**

Term hours: 36 lecture and 72 laboratory. Introduction to three-dimensional sculptural principles, techniques, and concepts utilizing a wide range of materials and practices. Various sculpture methods are practiced with attention to creative self-expression and historical context. Combines lecture, demonstrations, and critique with hands-on exploration in problem solving. \$25.00 Material Fee- Payable at registration. (UC/CSU)

ART 150 C Ceramics Handbuilding**3 Units**

Term hours: 36 lecture and 72 laboratory. Basic information about ceramics will be covered. Learning to construct ceramic forms with hand-building techniques will be applied to convey ideas, images, and feelings. Visual vocabulary as it pertains to all of the arts will be stressed. Basic technology of clay, glazes, and firing procedures is included. \$20.00 Material Fee - Payable at Registration. (UC/CSU, AA GE, CSU GE)

ART 151 C Ceramics Throwing**3 Units**

Term hours: 36 lecture and 72 laboratory. Basic information about ceramics will be covered with an emphasis on learning to use the potter's wheel as a tool, students will use it to convey ideas, images, and feelings. Visual vocabulary as it pertains to all of the arts is emphasized. Basic technology of clay, glazes, and firing procedures are included. \$20.00 Material Fee-Payable at Registration. (UC/CSU, AA GE, CSU GE)

ART 152 C Technical and Conceptual Ceramics**3 Units**

Prerequisite: ART 150 C or ART 151 C with minimum grades of "C".
Term hours: 36 lecture and 72 laboratory. This course deals with advanced technical skills in ceramic construction and visual concepts. Identification and application of one's personal aesthetic will be emphasized. Clay, glazes, and firing techniques are integral to this course. \$20.00 Material Fee - Payable at Registration. (UC/CSU)

ART 153 C Ceramic Studio Exploration**3 Units**

Prerequisite: ART 152 C with a minimum grade of "C".
Term hours: 36 lecture and 72 laboratory. Advanced technical and conceptual skills will be covered. Synthesizing the individual development of a personal aesthetic will be used. Application of this aesthetic will be used to create ceramic objects. Further technology of clay, glazes, and firing possibilities is expected. \$20.00 Material Fee - Payable at Registration. (UC/CSU)

ART 154 C Ceramic Aesthetics and Finishes**3 Units**

Prerequisite: ART 153 C with a minimum grade of "C".
Term hours: 36 lecture and 72 laboratory. This class which explores various firing processes, glaze exploration and philosophy is designed for the advanced ceramic student. Developing a personal aesthetic towards the finished product will be emphasized. Experimentation of glazes will be stressed. \$20.00 Material Fee - Payable at Registration. (UC/CSU)

ART 155 C Art Open Laboratory**.5 to 2 Units**

Corequisite: Concurrent enrollment in ART 120 C, ART 130 C, ART 150-154 C, ART 182 C, ART 185 C or ART 244 C.
Term hours: 27-108 laboratory depending on units attempted. This course is designed as an open laboratory. Working time can be anytime the laboratory is open on an individual basis. This open lab with flexible hours and variable units is designed to provide students with space and equipment needed to complete art assignments. Twenty-seven (27) hours are required for each 1/2 unit up to 108 hours for two (2) units. May be taken for credit 4 times. Pass/No Pass. (CSU)

ART 161 C Gallery Studies 1**3 Units**

Formerly ART 122 C
Term hours: 32-36 lecture and 64-72 laboratory. In this introductory course in Gallery Studies students will be introduced to installation practices required to work in gallery and museum environments. Course will introduce Art handling, conservation, visitor relations, installation, construction and maintenance. (CSU)

ART 162 C Gallery Studies 2**3 Units**

Prerequisite: ART 161 C with a minimum grade of "C".
Term hours: 36 lecture and 72 laboratory. In this intermediate course in Gallery Studies students will learn to organize and market exhibitions in gallery and museum environments. Course topics include: Curatorial methods and ethics, exhibition design and management, promotion, community relations, and development of related exhibition programming. (CSU)

ART 163 C Gallery Studies 3**3 Units**

Prerequisite: ART 162 C with a minimum grade of "C".
Term hours: 36 lecture and 72 laboratory. In this advanced course students will learn to develop their career as a working artist and present their work for exhibition. Course topics include: portfolio development, marketing, networking, grants, and continued education, internships, and residencies. (CSU)

ART 166 C Contemporary Art Studio**3 Units**

Term hours: 36 lecture and 72 laboratory. This course introduces students to the practices of contemporary art, including current approaches to drawing and painting, sculpture, installation art, performance art, video, sound, and digital technologies. Students use a variety of traditional and digital processes to create works of art. This course is designed for Art majors. (UC/CSU)

ART 174 C Jewelry Design**3 Units**

Term hours: 36 lecture and 72 laboratory. This is a course covering the design and construction of jewelry and small fabricated metal pieces. Emphasis will be placed on fabrication and direct casting techniques and their potential. \$35.00 fee for materials used in common-Payable at Registration. (CSU)

ART 175 C Metalsmithing**3 Units**

Prerequisite: ART 174 C.

Term hours: 36 lecture and 72 laboratory. The emphasis of this course will be placed on the development of advanced design skills, lost wax casting and stone setting techniques. \$35.00 fee for materials used in common-Payable at Registration. (CSU)

ART 182 C Beginning Drawing**3 Units**

Term hours: 36 lecture and 72 laboratory. This course is an introductory class in the fundamentals of drawing. The student will be exploring traditional and experimental methods in drawing. There is strong emphasis on foundation skills such as form, value, composition and perspective. Perceptual skills and self expression will also be stressed. The student will work from nature, man made objects and his or her own imagination. Non objective and abstract considerations will be examined in representational and experimental drawing. A variety of media will be introduced, such as graphite, charcoal, conte, pen and ink. Advanced students will be exposed to more color and mixed media. (UC/CSU, AA GE, CSU GE, C-ID: ARTS 110)

ART 183 C Intermediate Drawing**3 Units**

Prerequisite: ART 182 C with a minimum grade of "C".

Term hours: 36 lecture and 72 laboratory. This course is a continued study of drawing techniques and media. As a creative process, emphasis is placed upon individual experimentation as well as continued skills development and conceptual application pertaining to drawing. (UC/CSU, C-ID: ARTS 205)

ART 184 C Advanced Drawing**3 Units**

Prerequisite: ART 183 C.

Term hours: 36 lecture and 72 laboratory. This course constitutes a study of advanced drawing issues stressing experimentation, traditional and contemporary drawing composition and methods. Emphasis is upon a body of work demonstrating individual conceptualism and material exploration. (UC/CSU)

ART 185 C Beginning Life Drawing**3 Units**

Term hours: 36 lecture and 72 laboratory. Beginning Life Drawing is an introduction to the representational and expressive drawing of the human figure. It is a foundation for figure painting. The course provides an opportunity for exploration of various methods, approaches, and media in figure drawing. (UC/CSU, AA GE, C-ID: ARTS 200)

ART 186 C Intermediate Life Drawing**3 Units**

Prerequisite: ART 185 C with a minimum grade of "C".

Term hours: 36 lecture and 72 laboratory. The course is an intermediate course in drawing the human figure. The course emphasizes the refinement of basic skills, exercises and anatomy. Experimentation of different media and encouraged growth and personal vision are encouraged at this level. Recommended for all art majors. (UC/CSU)

ART 187 C Advanced Life Drawing**3 Units**

Prerequisite: ART 186 C with a minimum grade of "C".

Term hours: 36 lecture and 72 lecture. This is an advanced course in drawing the human figure. The emphasis of this course is a focused review of previous drawing exercises and the refinement of techniques. Advanced studio problems will be addressed, with historical and contemporary examples. Two hours lecture and four hours of studio per week. Recommended for art majors. (UC/CSU)

ART 191 C Life Painting**3 Units**

Prerequisite: ART 185 C or ART 194 C with minimum grades of "C".

Term hours: 36 lecture and 72 laboratory. Life Painting is an introduction to painting the human figure as a means to a more penetrating perception of visual phenomena and as a means of creative expression. Paintings will progress from a limited palette to full color with the emphasis on light, color, composition and form. The course provides an opportunity for examination of historical and contemporary examples of figure painting and for exploration of various methods, approaches and media. This course satisfies the requirements for units in lower division Life Painting for transfer. (UC/CSU)

ART 193 C Portrait Painting**3 Units**

Prerequisite: ART 191 C with a minimum grade of "C".

Term hours: 36 lecture and 72 laboratory. This is an advanced course in Life Painting. The emphasis will be developing the portrait through schematic studies and observational methods using models. Paintings will progress from limited palette to full color with emphasis on light, color, facial expression and form. Study of Historical and Interpretive styles in figurative work will be investigated. (UC/CSU)

ART 194 C Beginning Painting**3 Units**

Formerly ART 189 C

Term hours: 36 lecture and 72 laboratory. The purpose of this course is to approach painting as a creative and problem solving process. Emphasis will be placed on the acquisition of technical/formal skills and the development of a personal artistic vision. This course will include a variety of media and the fundamentals of composition, color theory, and craftsmanship as applied to painting and the fine arts. (UC/CSU, AA GE, CSU GE, C-ID: ARTS 210)

ART 195 C Intermediate Painting**3 Units**

Prerequisite: ART 194 C.

Term hours: 36 lecture and 72 laboratory. This course is a continued study of painting techniques and media. As a creative process, emphasis is placed upon individual experimentation as well as continued skills development and conceptual application pertaining to painting. (UC/CSU)

ART 196 C Advanced Painting**3 Units**

Prerequisite: ART 195 C.

Term hours: 36 lecture and 72 laboratory. This course constitutes a study of advanced painting problems stressing experimentation, traditional and contemporary painting composition and methods. Emphasis is upon a body of work demonstrating individual conceptualism and material exploration. (UC/CSU)

ART 216 C Latin American Art**3 Units**

Advisory: ENGL 100 C.

Term hours: 54 lecture. This course is a survey of arts and architecture of Mexico, Central America, and South America from 1200 BC to the late 20th century. Pass/No Pass/Letter Grade Option. Cost of museum visit will not exceed \$15.00. (UC/CSU, AA GE, CSU GE, IGECT)

ART 244 C Illustration**3 Units***Advisory: ART 182 C.*

Term hours: 36 lecture and 72 laboratory. This is an introductory course in the art of illustration. Primary emphasis is on the design and execution of illustrations for various uses in a variety of media. Course content includes designing to communicate a message, composition, style, development of preliminary drawings, preparation of drawings for printed reproduction, and experiments in the use of various media. The business of Illustration is also introduced in this class. \$20.00 Material Fee-Payable at Registration. (CSU)

ART 246 C Advanced Illustration**3 Units***Prerequisite: ART 244 C.*

Term hours: 36 lecture and 72 laboratory. This advanced level course in illustration presents the student with the opportunity to create an elevated and accelerated level of problem solving within the creation of finished illustrations, from thumbnail sketches to final art. Emphasis in this course is critical thinking skills, conceptual skills, addressing aesthetic intent for the illustration for printed media, such as books, newspapers, magazines as well as illustration for the web and electronic entertainment, theme park and motion picture industries. Projects are designed to prepare the student for the professional skills necessary in creating an industry appropriate portfolio of work and for transfer to a 4 year institution. Materials Fee \$20.00 - Payable at Registration. (CSU)

ART 298 C Art Seminar**.5 to 12 Units***Prerequisite: May be required.**Corequisite: May be required.**Advisory: May be required.*

Term hours: 0-216 lecture and/or 0-864 laboratory depending on units attempted. Various classes may be offered which are designed to meet the interests and needs of the student and faculty. May be taken for credit 1-4 times. Pass/No Pass or Pass/No Pass/Letter Grade Option or Standard Letter Grade. Fees may be required - Payable at Registration or Bookstore. (UC Credit Limitation/CSU)

ART 299 C Independent Study**.5 to 2 Units***Prerequisite: Approved Independent Study Learning Contract.*

Term hours: 18-72 conference/contract. This is a course that is designed for the student to pursue an increased knowledge of a particular art discipline. Unit credit may range from 1/2 to 2 units in any given semester; units earned will be based on 18 hours for each 1/2 unit. May be taken for credit 4 times. (UC Credit Limitation) (CSU)

Asian Studies

TRANSFER PROGRAM

Students should consult a counselor or www.assist.org for lower division major requirements for most California public universities. (See the Standard Definitions section of the catalog for a description of ASSIST.) Students transferring to an independent college/university should consult the catalog of the individual school and a counselor for lower division major requirements.

Astronomy

Division of Science/Engineering/Mathematics

Division Dean — Richard Fee*Faculty*

Ron Armale

Michael Frey

Counselor

Deidre Porter

PROGRAM LEARNING OUTCOMES (PLOs)

The courses taught by this department contribute to the General Education and Basic Skills Program Learning Outcomes. Please refer to General Education and Basic Skills Program Learning Outcomes.

Astronomy (ASTR)

ASTR 116 C Introduction to Astronomy**3 Units**

Term hours: 54 lecture. This course is an introduction to the ideas, concepts, and theories of astronomy. Topics include the night sky, history of astronomy, the solar system, extra solar planets, stars, the interstellar medium, galaxies, cosmology, and extraterrestrial life in the universe. On-campus observation sessions may be held. Duplicate credit not granted for ASTR 116HC. Pass/No Pass/Letter Grade Option. (UC Credit Limitation/CSU, AA GE, CSU GE, IGETC)

ASTR 116HC Honors Introduction to Astronomy**3 Units**

Term hours: 54 lecture. This course is an enhanced introduction to the concepts and theories of astronomy. Topics include the night sky, history of astronomy, the solar system, the sun, moon, planets, extra solar planets, stars, the interstellar medium, black holes, galaxies, cosmology, and life in the universe. Telescope observation sessions will be held on campus. Duplicate credit not granted for ASTR 116 C. (UC Credit Limitation/CSU, AA GE, CSU GE, IGETC)

ASTR 117 C Astronomy Lab**1 Unit***Prerequisite: Completion of or concurrent enrollment in ASTR 116 C or ASTR 116HC with a minimum grade of "C".*

Term hours: 54 laboratory. This course comprises an introduction to techniques of Astronomical measurement and analysis of Astronomical data. Emphasis will be on understanding how scientific knowledge is constructed, i.e. answering the question: how do we know what we know about the universe? Students will perform hands-on measurements, observations and exercises in data analysis relating to the solar system, stars, galaxies, large-scale structure of the universe, and cosmology. On campus telescopic observing may be done by students in the Astronomy Laboratory. Duplicate credit not granted for ASTR 117HC. (UC Credit Limitation/CSU, AA GE, CSU GE, IGETC)

ASTR 117HC Honors Astronomy Lab**1 Unit***Prerequisite: Completion of or concurrent enrollment in ASTR 116 C or ASTR 116HC with minimum grades of "C".*

Term hours: 54 laboratory. This enhanced course comprises an introduction to Astronomical measurement and analysis of Astronomical data. Emphasis will be on how scientific knowledge is constructed, i.e. answering the question: how do we know what we know about the universe? Students will perform hands-on measurements, observations and exercises in data analysis relating to the solar system, stars, galaxies, large-scale structure of the universe, and cosmology. Students will learn how to use a telescope, which may be computer controlled and take digital images. Duplicate credit not granted for ASTR 117 C. (UC Credit Limitation/CSU, AA GE, CSU GE, IGETC)

Automotive Collision Repair

Division of Career Technical Education

Division Dean — Kathleen Reiland, Interim

Faculty

Daniel Snook
Larry Ramos

Counselor

Jane Jepson

PROGRAM LEARNING OUTCOMES (PLOs)

Auto Collision Repair

Upon completion of the Automotive Collision Repair courses students will be able to develop the following skills required by the National Automotive Technology Education Foundation (NATEF) to enhance their employment opportunities and advance their career goals:

- Measure and diagnose structural damage using tram gauges and electronic measuring systems.
- Determine the extent and direction of damage; plan and document the methods and sequence of repairs.
- Remove and replace damaged sections of steel and aluminum body structures.
- Clean and prepare metal to be welded, assure good metal fit-up, clamp and tack weld as required.
- Perform the following welds: continuous, plug, butt weld with and without backing and fillet etc.
- Inspect, remove, store and replace body panels and components that may interfere with or be damaged during repair.
- Straighten contours of damaged panels to a suitable condition for body filling or metal finishing using power tools, hand tools and weld-on pulling attachments.
- Restore corrosion protection throughout all repair areas.
- Demonstrate hammer and dolly techniques including hot and cold shrinking of panel areas to proper contour.
- Mix and apply body filler and sand to correct contour.
- Inspect, adjust, repair or replace window regulators, run channels, glass, power mechanisms, and related controls.
- Perform visual and destructive tests on each type of weld.
- Identify types of plastics; rigid, semi-rigid or flexible and determine repairability.
- Clean, inspect and repair reusable fasteners and identify one-time use fastener.

ASSOCIATE IN SCIENCE DEGREE AUTOMOTIVE COLLISION REPAIR

Program Code: 1S07832

The following program is designed to prepare students for employment as automotive collision technicians and in numerous other related areas of the automotive and transportation industry. Training is given in both theory and practical skills. Directed practical work is given in all areas of automotive collision repair under simulated on-the-job conditions. The program suggested will provide the student the opportunity to acquire the knowledge and skills demanded of the modern automotive collision technician.

To earn an Associate Degree students must complete: (1) all major course requirements with a minimum grade of “C”; (2) 25 units of General Education Graduation Requirements; (3) the cultural diversity and reading requirements; (4) any elective courses to complete a minimum of 60 units; and, (5) have a minimum GPA of 2.0. At least 50% of all major course work must be completed at Cypress College.

Courses that fulfill major requirements for an Associate Degree at Cypress College might not be the same as those required for completing the major at a transfer institution offering a Baccalaureate Degree. For information on specific university requirements, please consult with your counselor, or visit the Transfer Center.

Required Courses are listed in suggested sequence:

| Course # | Title | Units |
|-----------------------------|---|-----------|
| ACR 001 C | Auto Collision Repair Tech I | 6 |
| ACR 002 C | Auto Collision Repair Tech II | 6 |
| ACR 003 C | Auto Collision Repair Tech III | 6 |
| ACR 004 C | Auto Collision Repair Tech IV | 6 |
| ACR 007 C | Refinishing Technician I | 6 |
| ACR 008 C | Refinishing Technician II | 6 |
| ACR 012 C | Collision Damage Appraisal | 3 |
| ACR 030 C | Electrical Systems and Component Repair | 4 |
| ACR 040 C | Structural Alignment Repair | 4 |
| Total Units Required | | 47 |

AUTOMOTIVE COLLISION REPAIR CERTIFICATE

Program Code: 1C21110

Primary emphasis is to prepare the student for occupational competency. To earn a certificate, students must complete the required courses as listed with a minimum grade of “C.” At least 50% of all course work must be completed at Cypress College.

Required courses are listed in suggested sequence:

| Course # | Title | Units |
|--|---|--------------|
| ACR 001 C | Auto Collision Repair Tech I | 6 |
| ACR 002 C | Auto Collision Repair Tech II | 6 |
| ACR 003 C | Auto Collision Repair Tech III | 6 |
| ACR 004 C | Auto Collision Repair Tech IV | 6 |
| ACR 007 C | Refinishing Technician I | 6 |
| ACR 008 C | Refinishing Technician II | 6 |
| ACR 012 C | Collision Damage Appraisal | 3 |
| ACR 030 C | Electrical Systems and Component Repair | 4 |
| ACR 040 C | Structural Alignment Repair | 4 |
| Select a minimum of 3–4 units from the elective courses listed below | | 3–4 |
| Total Units Required | | 50–51 |

| Electives | | |
|------------------|--|-----|
| ACR 013 C | Computerized Automotive Damage Appraisal | 3 |
| ACR 020 C | Auto Detail/Car Care-Beginning | 3 |
| ACR 050 C | ACR/Special Projects | 2–3 |
| ACR 060 C | Collision Repair Management | 3 |
| ACR 070 C | Automotive Color Matching | 3 |
| AT 101 C | Survey of the Automobile | 3 |
| AT 105 C | Automotive Electrical I | 4 |
| MATH 010 C | Basic Mathematics | 4 |
| MGT 261 C | Small Business Management | 3 |
| MKT 208 C | Principles of Selling | 3 |
| COMM 050 C | Effective Communication | 3 |

AUTOMOTIVE DAMAGE APPRAISAL CERTIFICATE **Program Code: 1C12970**

The following program is designed to prepare students for employment as automotive damage appraisers. Training is given in both theory and practical application. Directed practical work is given in all areas of automotive damage appraisal.

To earn a certificate, students must complete the required courses as listed with a minimum grade of "C." At least 50% of all course work must be completed at Cypress College.

Required courses are listed in numeric sequence:

| Course # | Title | Units |
|-----------------------------|--|--------------|
| ACR 001 C | Auto Collision Repair Technician I | 6 |
| ACR 007 C | Refinishing Technician I | 6 |
| ACR 012 C | Collision Damage Appraisal | 3 |
| ACR 013 C | Computerized Automotive Damage Appraisal | 3 |
| Total Units Required | | 18 |

AUTOMOTIVE PAINT AND REFINISHING CERTIFICATE **Program Code: 1C07833**

This program is designed to prepare students with the skills necessary to enter the Auto Paint and Refinishing industry. Training is given in both theory and practical skills. Directed practical work is given under simulated on-the-job conditions.

To earn a certificate, students must complete the required courses as listed with a minimum grade of "C." At least 50% of all course work must be completed at Cypress College.

Required courses are listed in suggested sequence:

| Course # | Title | Units |
|---|--------------------------------|--------------|
| ACR 001 C | Auto Collision Repair Tech I | 6 |
| ACR 007 C | Refinishing Technician I | 6 |
| ACR 008 C | Refinishing Technician II | 6 |
| ACR 012 C | Collision Damage Appraisal | 3 |
| ACR 020 C | Auto Detail/Car Care-Beginning | 3 |
| ACR 070 C | Automotive Color Matching | 3 |
| Select a minimum of 6 units from the elective course list | | 6 |
| Total Units Required | | 33 |

| Electives | | |
|------------------|-----------------------------|-----|
| ACR 021 C | Advanced Auto Detailing | 3 |
| ACR 050 C | ACR/Special Projects | 2–3 |
| ACR 060 C | Collision Repair Management | 3 |
| AT 101 C | Survey of the Automobile | 3 |
| MKT 208 C | Principles of Selling | 3 |

AUTOMOTIVE SALES AND SERVICE CERTIFICATE **Program Code: 1C15688**

This program is designed to prepare students for customer service and sales positions in the automotive industry. It provides students with a basic knowledge of automobile operations, general maintenance requirements, and damage appraisal procedures along with marketing and management principles. The certificate will enable students to work in a variety of non-technical areas in an automobile dealership, repair shop, or insurance company as a service representative, salesperson, or estimator.

To earn a certificate, students must complete the required courses as listed with a minimum grade of "C." At least 50% of all course work must be completed at Cypress College.

Required courses are listed in suggested sequence:

| Course # | Title | Units |
|-----------------------------|---------------------------------------|--------------|
| AT 101 C | Survey of the Automobile | 3 |
| or | | |
| AT 110 C | Introduction to Automotive Technology | (4) |
| ACR 012 C | Collision Damage Appraisal | 3 |
| MKT 222 C | Principles of Marketing | 3 |
| MKT 208 C | Principles of Selling | 3 |
| MGT 266 C | Human Relations in Business | 3 |
| Total Units Required | | 15–16 |

INSURANCE CO/AUTO COLLISION REPAIR INDUSTRY MANAGEMENT CERTIFICATE **Program Code: 1C12982**

This program is designed to prepare students for employment as insurance company appraisers and managers of automotive collision repair facilities. It is also designed to give the students knowledge in the auto collision repair process and to develop management skills necessary for success in their chosen profession.

To earn a certificate, students must complete the required courses as listed with a minimum grade of "C." At least 50% of all course work must be completed at Cypress College.

Required courses are listed below:

| Course # | Title | Units |
|-----------------------------|-----------------------------|--------------|
| ACR 007 C | Refinishing Technician I | 6 |
| ACR 060 C | Collision Repair Management | 3 |
| AT 101 C | Survey of the Automobile | 3 |
| MGT 151 C | Business Mathematics | 3 |
| MGT 055 C | Business English | 3 |
| or | | |
| MGT 111 C | Business Communications | (3) |
| Total Units Required | | 18 |

COLLISION REPAIR AUTOMOTIVE SALES AND SERVICE CERTIFICATE Program Code: 1C31348

This program is designed to prepare students for customer service and sales positions in the automotive industry. It provides students with a basic knowledge of automobile operations, general maintenance requirements, damage appraisal procedures along with marketing and management principles. The certificate will enable students to work in a variety of non-technical areas in an automobile dealership, repair shop, or insurance company as a service representative, salesperson, or estimator.

To earn a certificate, students must complete the required courses as listed with a minimum grade of "C" or higher. At least 50% of all course work must be completed at Cypress College.

| Required courses are listed in suggested sequence: | | Units |
|---|---------------------------------------|--------------|
| ACR 012 C | Collision Damage Appraisal | 3 |
| AT 110 C | Introduction to Automotive Technology | 4 |
| MKT 094 C | Buyer Behavior | .5 |
| MKT 097 C | Customer Relations | .5 |
| MKT 208 C | Principles of Selling | 3 |
| MKT 222 C | Principles of Marketing | 3 |
| MGT 266 C | Human Relations in Business | 3 |
| Total Units Required | | 17 |

COLLISION REPAIR BODY TECHNICIAN CERTIFICATE Program Code: 1C31491

This course covers principles of auto construction, nomenclature, removal of panels and basic body repair. Introduction to Automotive Technology including powertrains, suspension and brakes will provide a basic understanding of the automobile repair process.

To earn this certificate students must complete the required courses as listed with a minimum grade of "C," or higher. At least 50% of all course work must be completed at Cypress College.

| Required courses are listed in suggested sequence: | | Units |
|---|--------------------------------|--------------|
| AT 101 C | Survey of the Automobile | 3 |
| ACR 001 C | Auto Collision Repair Tech I | 6 |
| ACR 002 C | Auto Collision Repair Tech II | 6 |
| ACR 003 C | Auto Collision Repair Tech III | 6 |
| ACR 050 C | ACR/Special Projects | 2-3 |
| Total Units Required | | 23-24 |

COLLISION REPAIR TECHNICIAN ASSISTANT CERTIFICATE Program Code: 1C31492

The following certificate will prepare students for employment as an entry level collision body repair assistant. The courses provided will give students a fundamental understanding of engines, power trains, brakes and suspension. Topics include tools of the trade and their proper usage, sheet metal welding, door and panel replacement and alignment. Front sheet metal repairs and alignment.

To earn a certificate, students must complete the required courses as listed with a minimum grade of "C" or higher. At least 50% of all course work must be completed at Cypress College.

| Required courses are listed in suggested sequence: | | Units |
|---|-------------------------------|--------------|
| AT 101 C | Survey of the Automobile | 3 |
| ACR 001 C | Auto Collision Repair Tech I | 6 |
| ACR 050 C | ACR/Special Projects | 2-3 |
| ACR 002 C | Auto Collision Repair Tech II | 6 |
| Total Units Required | | 17-18 |

AUTOMOTIVE COLLISION CENTER DAMAGE APPRAISER CERTIFICATE Program Code: 1C31350

The following program is designed to prepare students for employment as collision center damage appraisers. Training is given in both theory and practical application. Directed practical work is given in all areas of automotive damage appraisal. Additional training is incorporated to teach the basic selling skills needed to obtain employment in a modern collision facility.

To earn a certificate, students must complete the required courses as listed with a minimum grade of "C." At least 50% of all course work must be completed at Cypress College.

| Required courses are listed in suggested sequence: | | Units |
|---|--|--------------|
| AT 101 C | Survey of the Automobile | 3 |
| ACR 012 C | Collision Damage Appraisal | 3 |
| ACR 013 C | Computerized Automotive Damage Appraisal | 3 |
| MKT 208 C | Principles of Selling | 3 |
| MGT 266 C | Human Relations in Business | 3 |
| MGT 151 C | Business Mathematics | 3 |
| Total Units Required | | 18 |

AUTO COLLISION REPAIR CENTER MANAGEMENT CERTIFICATE Program Code: 1C31351

Combining Collision repair principles, managerial skills with business practices, this certificate program provides students with the necessary knowledge to effectively manage a modern collision repair facility. Students will gain a superior understanding of all collision repair facility functions. An emphasis is placed on developing the skill set to manage employees and a base knowledge of small business management.

To earn a certificate, students must complete the required courses as listed with a minimum grade of "C." At least 50% of all course work must be completed at Cypress College.

| Required courses are listed in suggested sequence: | | Units |
|---|--|--------------|
| ACR 007 C | Refinishing Technician I | 6 |
| ACR 001 C | Auto Collision Repair Tech I | 6 |
| AT 101 C | Survey of the Automobile | 3 |
| MGT 261 C | Small Business Management | 3 |
| MGT 262 C | Principles of Management | 3 |
| MGT 266 C | Human Relations in Business | 3 |
| ACR 060 C | Collision Repair Management | 3 |
| ACR 012 C | Collision Damage Appraisal | 3 |
| ACR 013 C | Computerized Automotive Damage Appraisal | 3 |
| Total Units Required | | 33 |

AUTOMOTIVE COLLISION CENTER OFFICE MANAGEMENT CERTIFICATE

Program Code: 1C31349

This program is designed to prepare students for employment as office managers in a modern collision repair facility. Instruction is designed to give the students a general knowledge of the auto collision repair process. An emphasis is placed on developing the skill set to manage office employees and handle small business administration including human resource management.

To earn a certificate, students must complete the required courses as listed with a minimum grade of "C" or higher. At least 50% of all course work must be completed at Cypress College.

| Required courses are listed in suggested sequence: | | Units |
|--|--|-----------|
| AT 101 C | Survey of the Automobile | 3 |
| ACR 013 C | Computerized Automotive Damage Appraisal | 3 |
| ACR 060 C | Collision Repair Management | 3 |
| CIS 075 C | Business Skills Development | 3 |
| MGT 266 C | Human Relations in Business | 3 |
| MGT 268 C | Human Resources Management | 3 |
| Total Units Required | | 18 |

COLLISION REPAIR CENTER PARTS MANAGER CERTIFICATE

Program Code: 1C31347

This curriculum is designed to prepare the student for employment in the field of collision center parts management. The program incorporates managing skills and techniques with basic collision center functions and operations with an emphasis on human relations in business.

To earn a certificate, students must complete the required courses as listed with a minimum grade of "C" or higher. At least 50% of all course work must be completed at Cypress College.

| Required courses are listed in suggested sequence: | | Units |
|--|--|-----------|
| ACR 012 C | Collision Damage Appraisal | 3 |
| ACR 013 C | Computerized Automotive Damage Appraisal | 3 |
| AT 110 C | Introduction to Automotive Technology | 4 |
| MGT 266 C | Human Relations in Business | 3 |
| ACR 060 C | Collision Repair Management | 3 |
| Total Units Required | | 16 |

DETAIL TECHNICIAN CERTIFICATE

Program Code: 1C31343

This certificate will provide students with the knowledge necessary to enter the automotive detail trade with an emphasis on existing surface conditions, paint problems and their remedies.

To earn a certificate, students must complete the required courses as listed with a minimum grade of "C" or higher. At least 50% of all course work must be completed at Cypress College.

| Required courses are listed in suggested sequence: | | Units |
|--|--------------------------------|-----------|
| ACR 007 C | Refinishing Technician I | 6 |
| ACR 008 C | Refinishing Technician II | 6 |
| AT 101 C | Survey of the Automobile | 3 |
| ACR 020 C | Auto Detail/Car Care-Beginning | 3 |
| ACR 021 C | Advanced Auto Detailing | 3 |
| Total Units Required | | 21 |

AUTO COLLISION FACILITY PRODUCTION MANAGER CERTIFICATE

Program Code: 1C31352

The Collision Facility Production Manager Program provides students with a career path for attaining the communication skills, practical knowledge and managerial insight necessary for pursuing a career as a collision facility production manager. Students completing this certificate will develop an understanding of the daily operations of a collision center and the management skills necessary to enhance operational work flow.

To earn a certificate, students must complete the required courses as listed with a minimum grade of "C." At least 50% of all course work must be completed at Cypress College.

| Required courses are listed in suggested sequence: | | Units |
|--|--------------------------------|-----------|
| ACR 007 C | Refinishing Technician I | 6 |
| ACR 001 C | Auto Collision Repair Tech I | 6 |
| ACR 020 C | Auto Detail/Car Care-Beginning | 3 |
| ACR 060 C | Collision Repair Management | 3 |
| MGT 262 C | Principles of Management | 3 |
| Total Units Required | | 21 |

COLLISION REPAIR I-CAR GOLD CERTIFICATE

Program Code: 1C31346

The following program is designed to facilitate the student in acquiring the necessary knowledge and documentation to gain I-CAR training points when entering the automotive collision repair industry.

To earn a certificate, students must complete the required courses as listed with a minimum grade of "C" or higher. At least 50% of all course work must be completed at Cypress College.

| Required courses are listed in suggested sequence: | | Units |
|--|---|-----------|
| ACR 001 C | Auto Collision Repair Tech I | 6 |
| ACR 020 C | Auto Detail/Car Care-Beginning | 3 |
| ACR 021 C | Advanced Auto Detailing | 3 |
| ACR 070 C | Automotive Color Matching | 3 |
| ACR 030 C | Electrical Systems and Component Repair | 4 |
| ACR 040 C | Structural Alignment Repair | 4 |
| Total Units Required | | 23 |

COLLISION REPAIR MECHANICAL TECHNICIAN CERTIFICATE

Program Code: 1C31345

This program is designed to prepare students for employment in the field of collision repair with an emphasis on mechanical systems, electrical subsystems and supplemental restraint systems (SRS). Topics include bumper energy absorbing systems, automotive air conditioning, electrical test equipment, diagrams and schematics.

To earn a certificate, students must complete the required courses as listed with a minimum grade of "C" or higher. At least 50% of all course work must be completed at Cypress College.

| Required courses are listed in suggested sequence: | | Units |
|--|---|--------------|
| ACR 001 C | Auto Collision Repair Tech I | 6 |
| ACR 030 C | Electrical Systems and Component Repair | 4 |
| AT 105 C | Automotive Electrical I | 4 |
| AT 115 C | Automotive Air Conditioning | 4 |
| ACR 050 C | ACR/Special Projects | 2-3 |
| Total Units Required | | 20-21 |

COLLISION REPAIR PAINT APPLICATION SPECIALIST CERTIFICATE Program Code: 1C31344

This program is designed to prepare students for occupational competency in the automotive refinishing trade with an emphasis on color and application theory, matching solid, metallic and pearlescent colors. Topics include procedures, mixing equipment, surface preparation and topcoat application as well as general knowledge of the inner workings of the modern automobile.

To earn a certificate, students must complete the required courses as listed with a minimum grade of “C” or higher. At least 50% of all course work must be completed at Cypress College.

| Required courses are listed in suggested sequence: | | Units |
|--|--------------------------------|--------------|
| ACR 007 C | Refinishing Technician I | 6 |
| ACR 020 C | Auto Detail/Car Care-Beginning | 4 |
| ACR 021 C | Advanced Auto Detailing | 3 |
| ACR 050 C | ACR/Special Projects | 2–3 |
| Total Units Required | | 14–15 |

ADVANCED COLLISION REPAIR PAINT TECHNICIAN CERTIFICATE Program Code: 1C31341

This certificate will provide students with the knowledge necessary to enter the automotive refinishing trade with an emphasis on management, staffing, organizing and controlling workflow. Topics include surface conditions and their remedies; substrate application and final topcoats; spot painting and blending techniques; clean up details; surface anomalies, their repairs; and car care.

To earn a certificate, students must complete the required courses as listed with a minimum grade of “C” or higher. At least 50% of all course work must be completed at Cypress College.

| Required courses are listed in suggested sequence: | | Units |
|--|--------------------------------|-----------|
| ACR 007 C | Refinishing Technician I | 6 |
| ACR 008 C | Refinishing Technician II | 6 |
| ACR 070 C | Automotive Color Matching | 3 |
| ACR 020 C | Auto Detail/Car Care-Beginning | 3 |
| MGT 262 C | Principles of Management | 3 |
| Total Units Required | | 21 |

ADVANCED COLLISION REPAIR — STRUCTURAL TECHNICIAN CERTIFICATE Program Code: 1C31332

Advanced Collision Repair — Structural Technician. This certificate will prepare the student for occupational competency in the field of structural alignment, with an emphasis on brakes and suspension. Training is given in both theory and practical application. Topics include structural restoration, gauge, universal and dedicated measuring systems. Wheel alignment, balance techniques, power steering, disc and drum brake systems are included.

To earn a certificate, students must complete the required courses as listed with a minimum grade of “C” or higher. At least 50% of all course work must be completed at Cypress College.

| Required courses are listed in suggested sequence: | | Units |
|--|--------------------------------|--------------|
| ACR 040 C | Structural Alignment Repair | 4 |
| AT 130 C | Auto Chassis and Brake Systems | 12 |
| ACR 050 C | ACR/Special Projects | 2–3 |
| Total Units Required | | 18–19 |

Automotive Collision Repair (ACR)

ACR 001 C Auto Collision Repair Tech I 6 Units
 Term hours: 54 lecture and 162 laboratory. This course covers principles and fundamentals of automotive collision repair with emphasis on tools of the trade and their proper use. Sheetmetal straightening and welding is covered in depth. \$20.00 Material Fee-Payable at Registration.

ACR 002 C Auto Collision Repair Tech II 6 Units
Prerequisite: ACR 001 C with a minimum grade of “C”.
 Term hours: 54 lecture and 162 laboratory. This course covers principles and fundamentals of automotive collision repair with emphasis on tools of the trade, their proper use, and metal working techniques, including auto body sheet metal welding. \$20.00 Material Fee-Payable at Registration.

ACR 003 C Auto Collision Repair Tech III 6 Units
Prerequisite: ACR 002 C with a minimum grade of “C”.
 Term hours: 54 lecture and 162 laboratory. This course will cover major body repairs with welded panel replacement, panel alignment, upholstery removal and replacement. Glass removal and replacement, advanced metal work, including straightening of frames. \$20.00 Material Fee - Payable at Registration.

ACR 004 C Auto Collision Repair Tech IV 6 Units
Prerequisite: ACR 003 C with a minimum grade of “C”.
 Term hours: 54 lecture and 162 laboratory. This course will cover major body repairs with welded panel replacement, panel alignment, upholstery removal and replacement. Glass removal and replacement, advanced metal work, including straightening of frames. \$20.00 Material Fee - Payable at Registration.

ACR 007 C Refinishing Technician I 6 Units
 Formerly ACR 011 C
 Term hours: 90 lecture and 54 laboratory. This is the first introductory course to the automotive refinishing industry. Refinishing techniques with water base materials and urethane topcoat, equipment, procedures and techniques necessary to properly prepare and refinish the modern automobile. \$20.00 Material Fee - Payable at Registration.

ACR 008 C Refinishing Technician II 6 Units
Prerequisite: ACR 007 C with a minimum grade of “C”.
 Term hours: 90 lecture and 54 laboratory. Students will learn the use of basic auto refinishing water base materials, equipment, procedures and techniques necessary to properly prepare and refinish the modern automobile and related body parts. \$20.00 Material Fee - Payable at Registration.

ACR 009 C Refinishing Technician III 6 Units
Prerequisite: ACR 008 C with a minimum grade of “C”.
 Term hours: 90 lecture and 54 laboratory. Students will learn the use of advanced custom painting materials and techniques. Bumper Plastic Identification, plastic bumper paint repair preparation. Advanced painting techniques include tri stage repair procedures and proper color matching of base coat and mid coat. \$20.00 Material Fee - Payable at Registration.

ACR 012 C Collision Damage Appraisal 3 Units
 Term hours: 54 lecture. This course is designed to prepare students to enter the field of collision damage appraisal. Students will learn how to write repair estimates on damaged vehicles. The class will cover frame straightening, glass, paint and the use of various manuals.

ACR 013 C Computerized Automotive Damage Appraisal 3 Units

Prerequisite: ACR 012 C or equivalent, or minimum of one year estimating experience.

Term hours: 54 lecture. This course is designed for students who have had previous estimating training or some experience in automotive damage appraisal. Students will learn computer-based estimating software used in the collision repair industry. The course will give the student an opportunity to develop skills in computer-assisted estimate writing.

ACR 020 C Auto Detail/Car Care - Beginning 3 Units

Term hours: 36 lecture and 54 laboratory. This is an introductory automotive detailing and car care course. Detailing chemicals, processes, tools and equipment are covered in the class. Topics include the theory, diagnosis of paint conditions, and communication with the customer. Laboratory activities will emphasize skill competency in paint condition identification, washing, waxing, polishing and interior care.

ACR 021 C Advanced Auto Detailing 3 Units

Term hours: 36 lecture and 54 laboratory. This is an advanced course in automotive detailing and car care. Topics include: starting a detailing business, location determination, customer service, and advanced detailing techniques. Laboratory activities include receipt and delivery of customer vehicles, use of chemicals, and advanced detailing.

ACR 030 C Electrical Systems and Component Repair 4 Units

Prerequisite: Completion of or concurrent enrollment in ACR 002 C, ACR 003 C, or ACR 004 C; or employment in the industry.

Term hours: 72 lecture and 36 laboratory. This course will include advanced techniques in Auto Collision Repair. Topics included are: collision related electrical repairs, supplemental restraint systems (SRS), sheet mold compound (SMC), interior and exterior plastic repairs, plastic welding, bumper energy absorbing systems, air conditioning, sun roofs, aluminum repair and welding. Students are given practical applications for diagnosis, repair and servicing on both laboratory and live projects. \$20.00 Material Fee - Payable at Registration.

ACR 040 C Structural Alignment Repair 4 Units

Prerequisite: Completion of or concurrent enrollment in ACR 002 C, ACR 003 C, or ACR 004 C; or employment in the industry.

Term hours: 54 lecture and 54 laboratory. This course will emphasize the diagnosis and restructuring of the unitized automobile, light truck frame and body, use of manuals, structural restoration, centerline gauge use, dedicated measurement systems, sectioning techniques, corrosion protection, relationship of suspension and structural components.

ACR 050 C ACR/Special Projects 2 to 3 Units

Term hours: 18 lecture and 48-108 laboratory depending on units attempted. This course is designed to offer students a supervised independent program to continue and broaden their studies in automotive collision repairs. May be taken for credit 4 times.

ACR 055 C Automotive Collision Work Experience - Vocational 1 to 4 Units

Prerequisite: Must be enrolled in seven units, including work experience. Concurrent enrollment in Automotive Collision Program.

Term hours: 18 lecture and additional requirements depending on units attempted. The course requires a minimum of five hours employment in an automotive collision related occupation per week. Refer to class schedule for an explanation of unit credit. May be taken for credit 4 times.

ACR 060 C Collision Repair Management 3 Units

Term hours: 54 lecture. This course is designed for those interested in pursuing a management track in the collision repair industry. Areas covered include: vehicle check in, vehicle movement/tracking, financial statement analysis, production management, insurance practices with collision repair facilities, Bureau of Automotive Repair rules, quality control methods, equipment purchase/lease decisions, shop layout and design, managing multiple stores, and new car dealership collision repair centers.

ACR 070 C Automotive Color Matching 3 Units

Term hours: 54 lecture. This course is an introduction to the concepts and techniques of matching color applied to automobiles. The course covers color, light, and vision theory, spraygun application techniques and extensive use of solid, metallic, and pearl color match exercises. The class will be using automotive paint mixing systems. The student will be required to provide certain safety and respiratory protection equipment.

ACR 298 C Automotive Collision Repair Seminar .5 to 12 Units

Prerequisite: May be required.

Corequisite: May be required.

Advisory: May be required.

Term hours: 0-216 lecture and/or 0-1080 laboratory depending on units attempted. This is a course for students who wish to increase their knowledge of automotive collision repair. Various topics will be offered. Unit credit may range from 1/2 to 12 units in any given semester. Consult the class schedule to verify credit for a particular semester. May be taken for credit 1-4 times. Pass/No Pass or Pass/No Pass/Letter Grade Option or Standard Letter Grade. Fees may be required-Payable at Registration. (CSU)

Automotive Technology

Division of Career Technical Education

Division Dean — Kathleen Reiland, Interim

Faculty

John Alexander
Russell Bacarella
Michael Beard
Luciano Orozco
Paul Kelley
Michael Klyde

Toyota T-TEN Coordinator

Michael Klyde

Counselor

Jane Jepson

PROGRAM LEARNING OUTCOMES (PLOs)

Automotive Technology

Students who complete the Automotive Technology field of study will be able to develop the following skills required by the NATEF to enhance their employment opportunities and advance their career goals.

- Diagnose brake system, ABS systems, power booster systems, and suspension components; perform alignment; steering component diagnosis and repairs
- Utilize scan-tools, scopes DVOM's and other test equipment in trouble-shooting engine and transmission derivability problems

- Diagnose fuel system problems; service emission controls; diagnose fuel injection and Powertrain Control Module problems
- Diagnose electrical system problems; use test meters; overhaul electrical components.
- Diagnose and repair manual transmission systems, drivelines, differentials and 4-wheel drive/all wheel drive systems.
- Diagnosis and repair automatic transmission/transaxle systems, torque converters.
- Diagnose and repair heating and air conditioning systems including automated systems.
- Learn the structure and functions of an internal combustion engine; perform engine overhaul processes and diagnosis of mechanical engine components.
- Develop mathematical skills to use in analytical problem solving.
- Function as a shop service manager, shop foreman, or supervisor; learn safety management.
- Operate a Computer Customer Records System; perform service manager functions.
- Develop effective communication skills in dealing with customers in a simulated automotive business structure.

**ASSOCIATE IN SCIENCE DEGREE
AUTOMOTIVE
TECHNOLOGY**

Program Code: 1S03771

The following program is designed to prepare students for employment as automotive technicians and in numerous other related areas of the automotive and transportation industry. Training is given in both theory and practical skills. Directed practical work is given in all areas of automotive maintenance and repair under simulated on-the-job conditions. The sequence in which courses are taken may be modified to meet individual needs.

To earn an Associate Degree students must complete: (1) all major course requirements with a minimum grade of "C"; (2) 25 units of General Education Graduation Requirements; (3) any elective courses to complete a minimum of 60 units; and, (4) have a minimum GPA of 2.0. At least 50% of all major course work must be completed at Cypress College.

Courses that fulfill major requirements for an Associate Degree at Cypress College might not be the same as those required for completing the major at a transfer institution offering a Baccalaureate Degree. For information on specific university requirements, please consult with your counselor, or visit the Transfer Center.

**Required courses are listed in suggested sequence:
Select 4 of the following 5 core Automotive Technology
12 unit courses from the following:**

| Course # | Title | Units |
|-----------------------------|-----------------------------------|-----------|
| AT 120 C | Auto Engine Repair/Machining | 12 |
| AT 130 C | Auto Chassis and Brake Systems | 12 |
| AT 140 C | Auto Drivetrains/Transmissions | 12 |
| AT 150 C | Auto Performance and Driveability | 12 |
| AT 200 C | Electronic/Electrical Diagnostics | 12 |
| Total Units Required | | 48 |

Suggested electives — 25 units of general education course work with advisement from counselor.

**AUTOMOTIVE TECHNOLOGY
CERTIFICATE**

Program Code: 1C21109

This program is designed to prepare students for employment as automotive technicians. Training is given in both theory and practical skills. Directed practical work is given in all areas of the automotive maintenance and repair under simulated on-the-job conditions. The program will provide the student the opportunity to acquire the knowledge and skills demanded of the modern automotive technician. The sequence in which courses are taken may be modified to meet individual needs. Primary emphasis is to prepare the student for occupational competency in automotive technology.

To earn a certificate, students must complete the required courses as listed with a minimum grade of "C." At least 50% of all course work must be completed at Cypress College.

Required courses are listed in suggested sequence. The student must take AT 105 C Automotive Electrical I and then choose four of the five listed 12 unit courses:

| Course # | Title | Units |
|----------|-------------------------|-------|
| AT 105 C | Automotive Electrical I | 4 |

Plus choose four of the five listed 12 unit courses

| | | |
|----------|-----------------------------------|----|
| AT 120 C | Auto Engine Repair/Machining | 12 |
| AT 130 C | Auto Chassis and Brake Systems | 12 |
| AT 140 C | Auto Drivetrains/Transmissions | 12 |
| AT 150 C | Auto Performance and Driveability | 12 |

| | | |
|--|-----------------------------------|------|
| AT 200 C | Electronic/Electrical Diagnostics | (12) |
| Select a minimum of 3–4 units from the elective courses listed below | | 3 |

Electives

| | | |
|-----------|--|-------|
| AT 050 C | Auto Tech Special Projects | .5–3 |
| AT 101 C | Survey of the Automobile | 3 |
| AT 102 C | Automotive History | 3 |
| AT 110 C | Introduction to Automotive Technology | 4 |
| AT 115 C | Automotive Air Conditioning | 4 |
| AT 170 C | Clean Air Car Level 1 and 2 | 4 |
| AT 171 C | Advanced Clean Air Car Course | 2 |
| AT 280 C | Introduction to Alternative Fuels | 4 |
| AT 281 C | Introduction to Electric/Hybrid Vehicles | 4 |
| AT 209 C | Toyota Portfolio TPORT | 1 |
| AT 220 C | Lower Engine Blueprinting | 2 |
| AT 221 C | Upper Engine Blueprinting | 2 |
| AT 250 C | Advanced Performance/Driveability | 4 |
| AT 298 C | Automotive Service Seminar | .5–12 |
| MGT 266 C | Human Relations in Business | 3 |

Total Units Required 55–56

BRAKE AND ALIGNMENT SPECIALIST CERTIFICATE Program Code: 1C12972

This program is designed to prepare students for employment as automotive brake and alignment technicians. Training is given in theory and practical skills. Directed practical work is given in areas of automotive maintenance and repair under simulated on-the-job conditions. Particular emphasis is placed on those competencies required of brake, suspension, and alignment technicians. The program will provide the student the opportunity to acquire the knowledge and skills demanded of the modern automotive brake, suspension, and alignment technician. The sequence in which courses are taken may be modified to meet individual needs.

To earn a certificate, students must complete the required courses as listed with a minimum grade of "C." At least 50% of all course work must be completed at Cypress College.

Required courses are listed in suggested sequence:

| Course # | Title | Units |
|-----------------------------|--------------------------------|--------------|
| AT 130 C | Auto Chassis and Brake Systems | 12 |
| AT 105 C | Automotive Electrical I | 4 |
| Total Units Required | | 16 |

EMISSION CONTROL SPECIALIST CERTIFICATE Program Code: 1C12973

This program is designed to prepare students for employment as an automotive emission control specialist. Training is given in theory and practical skills. Directed practical work is given in areas of automotive maintenance and repair under simulated on-the-job conditions. Particular emphasis is placed on those competencies required of emission control technicians. The program will provide the student the opportunity to acquire the knowledge and skills demanded of the modern automotive emission control specialist. The sequence in which courses are taken may be modified to meet individual needs.

To earn a certificate, students must complete the required courses as listed with a minimum grade of "C." At least 50% of all course work must be completed at Cypress College.

Required courses are listed in suggested sequence:

| Course # | Title | Units |
|-----------------------------|-----------------------------------|--------------|
| AT 050 C | Auto Tech Special Projects | 3 |
| AT 105 C | Automotive Electrical I | 4 |
| AT 170 C | Clean Air Car Level 1 and 2 | 4 |
| AT 171 C | Advanced Clean Air Car Course | 2 |
| AT 250 C | Advanced Performance/Driveability | 4 |
| Total Units Required | | 17 |

ENGINE SPECIALIST CERTIFICATE Program Code: 1C12974

This program is designed to prepare students for employment as an automotive engine repair specialist. Training is given in theory and practical skills. Directed practical work is given in all areas of automotive maintenance and repair under simulated on-the-job conditions. Particular emphasis is placed on those competencies required of engine repair technicians and machinists. The program will provide the student the opportunity to acquire the knowledge and skills demanded of the modern automotive engine specialist. The sequence in which courses are taken may be modified to meet individual needs.

To earn a certificate, students must complete the required courses as listed with a minimum grade of "C." At least 50% of all course work must be completed at Cypress College.

Required courses are listed in suggested sequence:

| Course # | Title | Units |
|-----------------------------|------------------------------|--------------|
| AT 120 C | Auto Engine Repair/Machining | 12 |
| AT 105 C | Automotive Electrical I | 4 |
| Total Units Required | | 16 |

AUTOMOTIVE TECHNOLOGY - MAINTENANCE TECHNICIAN CERTIFICATE Program Code: 1C30326

This program is designed to prepare students for employment as automotive maintenance technicians in dealerships and independent repair shops. Training is given in theory and practical skills. Directed practical work is given in all areas of automotive maintenance and repair under simulated on-the-job conditions. Particular emphasis is placed on those competencies required of maintenance technicians. The program will provide the student the opportunity to acquire the knowledge and skills demanded of the modern maintenance technician. The sequence in which courses are taken may be modified to meet individual needs.

To earn a certificate, complete the required courses as listed with a minimum grade of "C." At least 50% of all course work must be completed at Cypress College.

Required courses are listed in suggested sequence:

| Course # | Title | Units |
|-----------------------------|---------------------------------------|--------------|
| AT 110 C | Introduction to Automotive Technology | 4 |
| AT 105 C | Automotive Electrical I | 4 |
| AT 111 C | Automotive Quick Service | 6 |
| AT 130 C | Auto Chassis and Brake Systems | 12 |
| AT 150 C | Auto Performance and Driveability | 12 |
| Total Units Required | | 38 |

**PERFORMANCE AND DRIVEABILITY
CERTIFICATE**

Program Code: 1C12975

This program is designed to prepare students for employment as an automotive performance and driveability specialist. Training is given in theory and practical skills. Directed practical work is given in areas of automotive maintenance and repair under simulated on-the-job conditions. Particular emphasis is placed on those competencies required of performance and driveability technicians. The program will provide the student the opportunity to acquire the knowledge and skills demanded of the modern automotive performance and driveability specialist. The sequence in which courses are taken may be modified to meet individual needs.

To earn a certificate, students must complete the required courses as listed with a minimum grade of "C." At least 50% of all course work must be completed at Cypress College.

Required courses are listed in suggested sequence:

| Course # | Title | Units |
|-----------------------------|-----------------------------------|-----------|
| AT 150 C | Auto Performance and Driveability | 12 |
| AT 105 C | Automotive Electrical I | 4 |
| Total Units Required | | 16 |

**AUTOMOTIVE SALES AND SERVICE
CERTIFICATE**

Program Code: 1C15688

This program is designed to prepare students for customer service and sales positions in the automotive industry. It provides students with a basic knowledge of automobile operations, general maintenance requirements, and damage appraisal procedures along with marketing and management principles. The certificate will enable students to work in a variety of non-technical areas in an automobile dealership, repair shop, or insurance company as a service representative, salesperson, or estimator.

To earn a certificate, students must complete the required courses as listed with a minimum grade of "C." At least 50% of all course work must be completed at Cypress College.

Required courses are listed in suggested sequence:

| Course # | Title | Units |
|-----------------------------|---------------------------------------|--------------|
| AT 101 C | Survey of the Automobile | 3 |
| | or | |
| AT 110 C | Introduction to Automotive Technology | (4) |
| ACR 012 C | Collision Damage Appraisal | 3 |
| MKT 222 C | Principles of Marketing | 3 |
| MKT 208 C | Principles of Selling | 3 |
| MGT 266 C | Human Relations in Business | 3 |
| Total Units Required | | 15–16 |

**AUTOMOTIVE TECHNOLOGY-
TOYOTA SPECIALIST
CERTIFICATE**

Program Code: 1C16598

This program is designed to prepare students for employment as automotive technicians in Toyota dealerships. Training is given in theory and practical skills. Directed practical work is given in all areas of automotive maintenance and repair under simulated on-the-job conditions. Particular emphasis is placed on those competencies required of Toyota technicians. The program will provide the student the opportunity to acquire the knowledge and skills demanded of the modern Toyota technician. The sequence in which courses are taken may be modified to meet individual needs.

To earn a certificate, students must complete the required courses as listed with a minimum grade of "C." At least 50% of all course work must be completed at Cypress College.

Required courses are listed in suggested sequence:

| Course # | Title | Units |
|-----------------------------|--|-----------|
| AT 109 C | Introduction to Toyota Automotive Technology | 4 |
| AT 105 C | Automotive Electrical I | 4 |
| | and | |
| AT 106 C | Automotive Electrical II | 4 |
| | and | |
| AT 107 C | Automotive Electrical III | 4 |
| | or | |
| AT 200 C | Electronic and Electrical Diagnostics | (12) |
| AT 130 C | Auto Chassis and Brake Systems | 12 |
| AT 115 C | Automotive Air Conditioning | 4 |
| AT 150 C | Auto Performance and Driveability | 12 |
| AT 121 C | Auto Engine Mechanical Concept | 6 |
| AT 140 C | Auto Drivetrains/Transmissions | 12 |
| Total Units Required | | 62 |

**TRANSMISSION SPECIALIST
CERTIFICATE**

Program Code: 1C12976

This program is designed to prepare students for employment as automotive transmission and power train specialist. Training is given in theory and practical skills. Directed practical work is given in areas of automotive maintenance and repair under simulated on-the-job conditions. Particular emphasis is placed on those competencies required of transmission and power train technicians. The program will provide the student the opportunity to acquire the knowledge and skills demanded of the modern automotive transmission and power train specialist. The sequence in which courses are taken may be modified to meet individual needs.

To earn a certificate, students must complete the required courses as listed with a minimum grade of "C." At least 50% of all course work must be completed at Cypress College.

Required courses are listed in suggested sequence:

| Course # | Title | Units |
|-----------------------------|--------------------------------|-----------|
| AT 140 C | Auto Drivetrains/Transmissions | 12 |
| AT 105 C | Automotive Electrical I | 4 |
| Total Units Required | | 16 |

AUTOMOTIVE TECHNOLOGY - ELECTRICAL DIAGNOSTIC SPECIALIST CERTIFICATE Program Code: 1C30325

This program is designed to prepare students for employment as an automotive electrical system diagnostic specialist. Course work includes theory and operation of electrical systems, the use of test instruments, and skill competency in electrical system diagnosis and repair. The program will provide the student the opportunity to acquire the knowledge and skills demanded of the modern automotive electrical system specialist. The sequence in which the courses are taken may be modified to meet individual needs.

To earn a certificate, students must complete the required courses as listed with a minimum grade of "C." At least 50% of all course work must be completed at Cypress College.

Required courses are listed in suggested sequence:

| Course # | Title | Units |
|-----------------------------|-----------------------------------|-----------|
| AT 200 C | Electronic/Electrical Diagnostics | 12 |
| AT 105 C | Automotive Electrical I | 4 |
| Total Units Required | | 16 |

Automotive Technology (AT)

AT 050 C Auto Tech Special Projects .5 to 3 Units

Prerequisite: Completion of or concurrent enrollment in AT 120 C or AT 130 C or AT 140 C or AT 150 C or AT 200 C with minimum grades of "C".

Term hours: 27 lecture and 162 laboratory TBA. This course will include supervised independent lab work on lab units and "live" vehicles. It is designed to allow the student to gain more practical experience repairing components and servicing automotive systems. Only approved project work will be allowed. May be taken for credit 4 times. \$30.00 Material Fee - Payable at Registration.

AT 100 C Technician Safety 1 Unit

Term hours: 18 lecture and 54 laboratory. This course covers the concepts and practices of a safe industrial work environment, including the use of tools and equipment, handling materials, rigging, fire prevention, power tools, accident investigation, personal protective equipment, hearing safety and the correct use of body mechanics will be covered. Pass/No Pass/Letter Grade Option. (CSU)

AT 101 C Survey of the Automobile 3 Units

Term hours: 54 lecture. This course provides basic knowledge of the automobile, including engines, power trains, suspension and brakes, electrical and fuel systems. Other areas of instruction will be in the discussion of services typically required to maintain modern automobiles and the use of tools and equipment normally used in the care of the automobile. (CSU)

AT 102 C Automotive History 3 Units

Term hours: 54 lecture. This course details the growth of the automotive industry in the U.S. from the late 1890's through the global business climate of today. Topics include biographical sketches of industry pioneers, geographical why's and where's of the industry, the roots of automotive design, and an in depth review of major engineering achievements. The course includes visits to historical automotive collections at a cost not to exceed \$40.00. (CSU)

AT 104 C Automotive Technology Repair Laboratory 2 Units

Prerequisite: AT 120 C or AT 130 C or AT 140 C or AT 150 C or AT 200 C all with minimum grades of "B".

Term hours: 108 laboratory. This course provides the opportunity for students to gain experience working on customer vehicles in a simulated repair environment. (CSU)

AT 105 C Automotive Electrical I 4 Units

Term hours: 54 lecture and 54 laboratory. This course introduces the concepts of electrical systems and electronic control of the automobile. Areas covered will include basic electrical concepts, batteries, starting systems, charging systems, and body electrical diagnosis. Course instruction will consist of lecture, demonstration, web based learning with student application in the use of test equipment on simulator boards and "on-car" diagnosis with electrical wiring diagrams, charts, and schematics. \$25.00 Material Fee-Payable at Registration. (CSU)

AT 106 C Automotive Electrical II 4 Units

Prerequisite: AT 105 C with a minimum grade of "B".

Term hours: 54 lecture and 54 laboratory. This course covers the concepts of body electrical systems and electronic control of the automobile. Areas covered will include vehicle body electrical system diagnosis, batteries, charging systems, and computer control of electronic systems. Course instruction will consist of lecture, demonstration, web based learning with student application in the use of test equipment on simulator boards and "on-car" diagnosis with electrical wiring diagrams, charts, and schematics. \$25.00 Material Fee - Payable at Registration. (CSU)

AT 107 C Automotive Electrical III 4 Units

Prerequisite: Completion of or concurrent enrollment in AT 106 C.

Term hours: 54 lecture and 54 laboratory. This course covers the concepts of advanced diagnostic principles of power train and body electrical systems as they relate to modern vehicle network systems including CAN, Powernet, and other manufacturer's network systems. Course instruction will consist of lecture, demonstration, web based learning with student application in the use of test equipment on simulator boards and "on-car" diagnosis with electrical wiring diagrams, charts, and schematics. \$25.00 Materials Fee - Payable at Registration. (CSU)

AT 109 C Introduction to Toyota Automotive Technology 4 Units

Term hours: 54 lecture and 54 laboratory. This course introduces the student to the concepts of automotive technology required for the Toyota Technician Training Education Network (Toyota T-TEN). \$25.00 Material Fee - Payable at Registration. (CSU)

AT 110 C Introduction to Automotive Technology 4 Units

Term hours: 54 lecture and 54 laboratory. This course provides essential knowledge of the automobile. Also included will be instruction in the use of tools, equipment and processes normally used in automotive service and repair. Emphasis will be on the operating principles, nomenclature of car care, inspection, preventive maintenance, and minor repair procedures. (CSU)

AT 111 C Automotive Quick Service 6 Units

Prerequisite: AT 110 C with a minimum grade of "C".

Term hours: 81 lecture and 81 laboratory. This course covers the essential content and skill practice for a technician to perform quick service skills including, shop safety, correct use of required tools, service information use, repair order write up/documentation, vehicle inspection, oil change, fluid flush and other quick service maintenance work. \$25 Material Fee - Payable at Registration. (CSU)

AT 112 C Toyota Electrical Systems  **12 Units**

Prerequisite: Completion of or concurrent enrollment in AT 109 C or AT 110 C with minimum grades of “C”.

Term hours: 162 lecture and 162 laboratory. This course emphasizes operating principles, design and repair procedures of automotive electrical/electronic systems. In addition, lighting systems, power windows, power door locks, under dash components, charging systems, starters, batteries, and computerized vehicle networks systems will be covered. Modern test equipment such as scan tools and oscilloscopes will be used. Skill competency development will be simulated under shop conditions on OBD II and newer vehicles. \$10.00 Materials Fee - Payable at Registration. (CSU)

AT 115 C Automotive Air Conditioning **4 Units**

Prerequisite: Completion of or concurrent enrollment in AT 105 C with a minimum grade of “C”.

Term hours: 54 lecture and 54 laboratory. This course emphasizes the acquisition of the practical skills needed to both understand principles of refrigeration and perform system diagnosis and repair. Demonstrated lecture, shop lab simulators and “live” vehicles will be used to learn service diagnosis, repair and installation of air conditioning systems including automatic temperature control. Safety and environmental concerns along with CFC recovery, recycling, retrofitting, and R-134A will be covered. \$25 Material Fee - Payable at Registration. (CSU)

AT 120 C Auto Engine Repair/Machining **12 Units**

Prerequisite: AT 105 C and AT 109 C or AT 110 C with minimum grades of “C”.

Term hours: 162 lecture and 162 laboratory. This course covers the acquisition of practical skills needed for accurate internal combustion engine diagnosis and repair and all phases of engine rebuilding machine work. Demonstrated lecture, simulated problem diagnosis, and practical application on “live” vehicles will be used. Individualized instruction on Automotive rebuilding tools and machinery is an integral part of this course. Engine theory, design, repair, practical and theoretical high performance modifications are part of the course. Preparation for ASE certification test A1 will be covered. \$30 Material Fee-Payable at Registration. (CSU)

AT 121 C Auto Engine Mechanical Concept **6 Units**

Prerequisite: AT 105 C and AT 106 C and AT 107 C and AT 109 C and AT 130 C all with minimum grades of “C”.

Term hours: 81 lecture and 81 laboratory. This course introduces engine designs and concepts used in current automotive applications by Toyota Motor Sales. Extensive lab experience will be provided. Preparation for ASE A1 will be covered. \$30.00 Material Fee - Payable at Registration. (CSU)

AT 130 C Auto Chassis and Brake Systems **12 Units**

Prerequisite: AT 105 C and AT 110 C with minimum grades of “C”.

Term hours: 162 lecture and 162 laboratory. This course emphasizes the design, operating principles, service, repair and diagnosis of chassis and brake systems used on current production vehicles. Major topics of study will be wheel alignment procedures, tire and wheel balance, suspension and steering, system repair, hydraulics, and brake system service and repair. Application will be applied under simulated repair shop procedures using “live” vehicles. Preparation for ASE (A4 and A5) certification will be covered. \$30.00 Material Fee-Payable at Registration. (CSU)

AT 140 C Auto Drivetrains/Transmissions **12 Units**

Prerequisite: AT 105 C and AT 110 C with minimum grades of “C”.

Term hours: 162 lecture and 162 laboratory. This course will include operation principles, design, repair, rebuild and service procedures for manual transmissions, automatic transmissions, clutch assemblies, drive lines, final drive axles and trans-axle units. Demonstrated lectures and shop laboratory work on drivetrain components will be covered with emphasis on procedures to industry standards. Practical application will be under simulated shop conditions on “live” and “lab” vehicles. Preparation of ASE certification will be covered. \$30 Material Fee-Payable at Registration. (CSU)

AT 141 C T-TEN Drivetrain and Transmissions  **6 Units**

Prerequisite: AT 109 C and AT 112 C with minimum grades of “C”.

Term hours: 81 lecture and 81 laboratory. This course will include operation principles, design, repair and service procedures for manual transmissions, automatic transmissions, clutch assemblies, drive lines, final drive axles and trans-axles units. Demonstrated lectures and shop laboratory work on drive train components will be covered with emphasis on procedures to industry standards. Practical application will be under simulated shop conditions on “live” and “lab” vehicles. Preparation for ASE certification will be covered. (CSU)

AT 150 C Auto Performance/Driveability **12 Units**

Prerequisite: AT 105 C and AT 110 C with minimum grades of “C”.

Term hours: 162 lecture and 162 laboratory. This course will include operating principles, design, and repair procedures of the computerized engine management system and the application of related diagnostic tools and equipment. In addition, alternators, starters, batteries, ignition systems, emission control systems, 5 gas analysis, and scan tool use will be covered. Skill competency development will be under simulated shop conditions on “live” vehicles. Preparation for ASE certification test A8 will be covered. \$30.00 Material Fee-Payable at Registration. (CSU)

AT 170 C Clean Air Car Level 1 and 2 **4 Units**

Advisory: AT 105 C.

Term hours: 54 lecture and 54 laboratory. This course prepares students for the State of California Smog Check license for level 1 and 2 applicants. Course includes safety, BAR rules and regulations, engine performance, and emission control devices. Modern diagnostic equipment including a BAR 5 gas analyzer, low pressure EVAP tester, and scan tools will be covered as applicable to California’s emissions inspection program. \$15.00 Material Fee - Payable at Registration. (CSU)

AT 171 C Advanced Clean Air Car Course **2 Units**

Term hours: 36 lecture. This course covers operating procedures, diagnostic strategies, and repair procedures for loaded mode emissions testing. Course emphasizes baseline techniques, five gas analysis and lab scope use. Course meets California BAR Smog Check licensing requirements. (CSU)

AT 195 C Automotive Service Advisor **4 Units**

Advisory: AT 110 C.

Term hours: 54 lecture and 54 laboratory. This is a course in the concepts and application of the Service Advisor’s job duties primarily as they apply to job skills required in the service department of new vehicle dealerships. Course instruction will include lecture, role playing, repair order writing, interactive computer based assignments, use of dealer management software, site visits and demonstration of knowledge in a simulated work environment. (CSU)

AT 200 C Electronic and Electrical Diagnostics **12 Units**

Prerequisite: Completion of or concurrent enrollment in AT 109 C and AT 110 C with minimum grades of “C”.

Term hours: 162 lecture and 162 laboratory. This course emphasizes operating principles, design and repair procedures of automotive electrical/electronic systems. In addition, lighting systems, power windows, power door locks, under dash components, charging systems, starters, batteries, and computerized vehicle networks systems will be covered. Modern test equipment such as scan tools and oscilloscopes will be used. Skill competency development will be simulated under shop conditions on OBD II and newer vehicles. \$30 Material Fee-Payable at Registration. (CSU)

AT 209 C Toyota Portfolio TPORT 1 Unit

Prerequisite: AT 109 C or consent of Toyota T-TEN Coordinator.

Term hours: 18 lecture. This course monitors the progress of T-TEN students through the program. This course will also prepare the student for placement in the dealership internship. This course must be taken every semester the student is in the T-TEN program. (CSU)

AT 211 C Toyota Professional Series I 4 Units

Advisory: AT 105 C. Automotive work experience is recommended for entry into this course. Content is geared towards working automotive technician.

Term hours: 54 lecture and 54 laboratory. This course is designed to familiarize the technician with a basic understanding in three of the Toyota training course; Basic Electrical (623), Body Electrical (653), Engine Controls (852) and Hybrid Vehicles. Diagnosis and Troubleshooting are covered. \$30.00 Material Fee-Payable at Registration. (CSU)

AT 212 C Toyota Professional Series II 4 Units

Advisory: Work experience in the automotive service industry is recommended. This course is designed for the working automotive technician.

Term hours: 54 lecture and 54 laboratory. This course is designed to familiarize the technician with a basic understanding of Toyota Suspension Systems (453), Toyota Brake Systems (553), Toyota Air Conditioning (752), Toyota Automatic Transmissions (274), Toyota Manual Transmissions (302). Diagnosis and Troubleshooting are covered. \$30.00 Material Fee-Payable at Registration. (CSU)

AT 213 C Toyota Portfolio II TPORT (II) 1 Unit

Term hours: 18 lecture. This course monitors the progress of T-TEN students through the program. This course focuses on their second year in the program with an emphasis on successful internship completion. This course must be taken in both the Fall and Spring semester the student is in year two of the T-TEN program. May be taken for credit 3 times. (CSU)

AT 215 C ASE Test Prep - Heating and A/C .5 Units

Term hours: 9 lecture. This is a review course and is designed to help prepare students to take and pass the ASE (National Institute for Automotive Service Excellence) heating and air conditioning certification test. This course will review the various task lists which detail the knowledge that a technician must have to pass the ASE heating and air conditioning certification test. Demonstrated lecture will include instruction concerning theory, operation, diagnosis, and repair of automotive climate control systems.

AT 220 C Lower Engine Blueprinting 2 Units

Prerequisite: AT 121 C or completion of or concurrent enrollment in AT 120 C with minimum grades of "C".

Term hours: 36 lecture. The course emphasizes the design, operation, and modification of modern engines. Students will learn how to use formulas, and software to design and modify the lower engine assembly. Students will also learn how to use precision tools to measurements in accordance with blueprint specifications. \$30.00 Material Fee - Payable at Registration. (CSU)

AT 221 C Upper Engine Blueprinting 2 Units

Prerequisite: AT 120 C or AT 121 C with a minimum grade of "C".

Term hours: 36 lecture. This course emphasizes the design, operation, and modification of modern engines. Students will learn how to use formulas, and software to design and modify the upper engine assembly. Students will also learn how to modify and prepare cylinder heads, intake systems and exhaust systems to optimize engine performance. \$30.00 Material Fee - Payable at Registration. (CSU)

AT 225 C ASE Test Prep - Engine Repair .5 Units

Term hours: 9 lecture. This is a review course and is designed to help prepare students to take and pass the ASE (National Institute for Automotive Service Excellence) engine repair certification test. This course will review the various task lists which detail the knowledge that a technician must have to pass the ASE engine repair certification test. Demonstrated lecture will include instruction concerning theory, operation, diagnosis, and repair of the automotive engine. (CSU)

AT 230 C Advanced Alignment and Chassis 4 Units

Prerequisite: AT 130 C with a minimum grade of "C".

Term hours: 54 lecture and 54 laboratory. This course covers advanced alignment concepts. Custom suspension theory and service is explored with practical laboratory experience included. \$30.00 Material Fee - Payable at Registration. (CSU)

AT 235 C ASE Test Prep - Brakes .5 Units

Term hours: 9 lecture. This is a review course and is designed to help prepare students to take and pass the ASE (National Institute for Automotive Service Excellence) brake certification test. This course will review the various task lists which detail the knowledge that a technician must have to pass the ASE brake certification test. Demonstrated lecture will include instruction concerning theory, operation, diagnosis, and repair of the automotive brake systems. (CSU)

AT 236 C ASE Test Prep - Steering and Suspension .5 Units

Term hours: 9 lecture. This is a review course and is designed to help prepare students to take and pass the ASE (National Institute for Automotive Service Excellence) steering and suspensions certification tests. This course will review the various task lists which detail the knowledge that a technician must have to pass the ASE steering and suspension certification test. Demonstrated lecture will include instruction concerning theory, operation, diagnosis, and repair of the automotive steering and suspension systems. (CSU)

AT 245 C ASE Test Prep - Manual Transmission .5 Units

Term hours: 9 lecture. This is a review course and is designed to help prepare students to take and pass the ASE (National Institute for Automotive Service Excellence) manual transmission and drive-train certification tests. This course will review the various task lists which detail the knowledge that a technician must have to pass the ASE manual transmission certification test. Demonstrated lecture will include instruction concerning theory, operation, diagnosis, and repair of manual transmission and drive-train systems. (CSU)

AT 246 C ASE Test Prep - Automatic Transmission .5 Units

Term hours: 9 lecture. This is a review course and is designed to help prepare students to take and pass the ASE (National Institute for Automotive Service Excellence) automatic transmission certification test. This course will review the various task lists which detail the knowledge that a technician must have to pass the ASE automatic transmission certification test. Demonstrated lecture will include instruction concerning theory, operation, diagnosis, and repair of automatic transmission. (CSU)

AT 250 C Advanced Performance and Driveability 4 Units

Prerequisite: Completion of or concurrent enrollment in AT 105 C and AT 110 C with minimum grades of "C".

Term hours: 72 lecture and 36 laboratory. The course includes advanced principles, design and repair procedures of automotive electrical, ignition and computerized engine management systems, including emission controls. Demonstrated lectures and laboratory work using modern testing equipment, oscilloscopes, dynamometer and other diagnostic equipment are included. Practical application under simulated repair shop conditions on "live" vehicles is an integral part of the course. (CSU)

AT 255 C ASE Test Prep - Engine Performance .5 Units

Term hours: 9 lecture. This is a review course and is designed to help prepare students to take and pass the ASE (National Institute for Automotive Service Excellence) engine performance certification test. This course will review the various task lists which detail the knowledge that a technician must have to pass the ASE engine performance certification test. Demonstrated lecture will include instruction concerning theory, operation, diagnosis, and repair of automotive engine. (CSU)

AT 256 C ASE Test Prep - Advanced Engine Performance .5 Units

Term hours: 9 lecture. This is a review course and is designed to help prepare students to take and pass the ASE (National Institute for Automotive Service Excellence) advanced engine performance certification test. This course will review the various task lists which detail the knowledge that a technician must have to pass the ASE advanced engine performance certification test. Demonstrated lecture will include instruction concerning theory, operation, diagnosis, and repair of automotive engine control systems. (CSU)

AT 265 C ASE Test Prep - Electrical .5 Units

Term hours: 9 lecture. This is a review course and is designed to help prepare students to take and pass the ASE (National Institute for Automotive Service Excellence) electrical certification test. This course will review the various task lists which detail the knowledge that a technician must have to pass the ASE electrical certification test. Demonstrated lecture will include instruction concerning theory, operation, diagnosis, and repair of automotive electrical systems. (CSU)

AT 280 C Introduction to Alternative Fuels 4 Units

Formerly AT 180 C

Term hours: 54 lecture and 54 laboratory. This is an introductory course in alternative fuels as used in the transportation industry. Various gaseous fuels and vehicle propulsion systems will be discussed. Topics include the theory, design, operation, conversion, light diagnosis, and light repair will be discussed as applicable by the automotive industry. Laboratory activities will emphasize skill competency in vehicle preparation, system maintenance and the diagnosis and repair of alternative fuel vehicles. (CSU)

AT 281 C Introduction to Electric/Hybrid Vehicles 4 Units

Formerly AT 181 C

Prerequisite: AT 105 C and AT 110 C with minimum grades of "B".

Term hours: 54 lecture and 54 laboratory. This is an introductory course in electric (EV) and electric/hybrid vehicles as used in the transportation industry. Topics include the theory, design, operation, maintenance, and repair of batteries, motors, controllers, chargers, and regenerative braking systems. Technician safety is also covered. (CSU)

AT 282 C Hybrid Vehicle Maintenance 4 Units

Prerequisite: Completion of or concurrent enrollment in AT 281 C.

Term hours: 54 lecture and 54 laboratory. This course covers hybrid and plug-in hybrid vehicle theory of operation, charging, batteries, maintenance process and procedures as specified by vehicle manufacturers. The course will be taught using lecture, collaborative work groups and lab. (CSU)

AT 295 C Automotive Internship 1 to 4 Units

Term hours: 18 lecture and 240 laboratory depending on units attempted. This course is designed to give the student credit for work experience at a related occupational worksite, while being concurrently enrolled in a vocational major. For each unit of credit, a minimum of 75 total hours of worksite hours for paid internships (minimum 60 hours for unpaid internships). The internship allows students to apply knowledge gained in college courses to an actual work setting, sample career choices and improve job-readiness skills. Supplemental reading and course assignments required. May be taken for credit 1-4 times. Open Entry/Open Exit. Pass/No Pass or Pass/No Pass/Letter Grade Option or Standard Letter Grade. (CSU)

AT 298 C Automotive Service Seminar .5 to 12 Units

Prerequisite: May be required.

Corequisite: May be required.

Advisory: May be required.

Term hours: 0-216 lecture and/or 0-648 laboratory depending on units attempted. This is a course for students who wish to increase their knowledge of automotive repair. Various topics will be offered. Unit credit may range from 1/2 to 12 units in any given semester. Consult the class schedule to verify credit for a particular semester. May be taken for credit 1-4 times. Pass/No Pass or Pass/No Pass/Letter Grade Option or Standard Letter Grade. Fee may be required-Payable at Registration. (CSU)

Aviation and Travel Careers

Division of Career Technical Education

Division Dean — Kathleen Reiland, Interim

Faculty

Kathleen Reiland

Capt. Edilberto Valdez

Counselor

Jane Jepson

PROGRAM LEARNING OUTCOMES (PLOs)

Aviation and Travel Careers

Students who receive a certificate from the Cypress College Aviation and Travel Careers Program

- Will have acquired the specified set of skills required for aviation/travel employment opportunities
- Will have achieved the necessary competencies to enter the aviation, cruise, travel, tourism fields
- Will be aware of additional educational and career opportunities within the aviation and travel industries

ARTICULATION AGREEMENTS ARE IN EXISTENCE FOR TRANSFER PROGRAMS TO THE FOLLOWING UNIVERSITIES:

Arizona State University

California State University, Los Angeles

San Jose State University

Southern Illinois University

Students should consult a counselor or www.assist.org for lower division major requirements for most California public universities. (See the Standard Definitions section of the catalog for a description of ASSIST.) Students transferring to an independent college/university should consult the catalog of the individual school and a counselor for lower division major requirements.

Air Force Reserve Officers Training Corps (AFROTC)

Through arrangements with the University of Southern California (USC) and Loyola Marymount University (LMU), three-, and four-year Air Force Reserve Officers Training Corps (AFROTC) programs are available to all qualified students at Cypress College. For additional information, visit www.afrotc.com.

Academic units earned in this program are counted as elective units toward fulfillment of graduation requirements. Successful completion of the AFROTC programs leads to a commission as an officer in the United States Air Force. Those students who qualify and desire to enter Air Force pilot training will be given flight instruction in either the two- or four-year program. Competitive scholarships are available to qualified students. All scholarship students receive tuition, laboratory and book fees, and \$350–\$500 a month. For additional information, contact the Department of Aerospace Studies (AFROTC) at Loyola Marymount at (310) 338-2770, or UCLA at (310) 825-1742 (www.afrotc.ucla.edu), or USC at (213) 740-2670.

**CERTIFICATED PILOTS —
CREDIT BY EXAMINATION**

The Commercial Pilot program at Cypress College is intended to prepare a student for employment in the aviation industry. Although the college offers only ground instruction and ground trainer instruction, it is recognized that flight training and pilot certificates are also required for employment.

In order to complete qualifications for employment, the student arranges for, and secures, the flight training necessary for the needed pilot certificates and ratings. Cypress College and the North Orange County Community College District assume no responsibility or liability for the flight training so obtained.

Pilot certificates and ratings issued to the student by the Federal Aviation Administration will be used as evidence and certification of competency. A maximum of 12 units will be granted via Credit by Examination.

**AVIATION AND TRAVEL CAREERS
TRANSFER PROGRAMS**

Students should consult a counselor or www.assist.org for lower division major requirements for most California public universities. (See the Standard Definitions section of the catalog for a description of ASSIST.) Students transferring to an independent college/university should consult the catalog of the individual school and a counselor for lower division major requirements.

AVIATION AND TRAVEL CAREERS PROGRAM

The Aviation and Travel Careers Program provides students with a career path for attaining the communication skills, practical knowledge, and technical training necessary to work in the aviation and travel industries.

Associate in Science Degrees:

- Airline Customer Services
- Aviation Management
- Commercial Pilot
- Flight Attendant
- Travel/Tourism
- UAV/UAS

Certificates:

- Advanced Airline Customer Services
- Advanced Flight Attendant
- Advanced Travel/Tourism
- Aviation I — Private Pilot
- Aviation II — Instrument Pilot
- Aviation III — Commercial Pilot
- Aviation IV — Advanced Pilot
- Aviation Management
- Basic Airline Customer Services
- Basic Airport Operations
- Basic Cruise Line Sales and Operations
- Basic Flight Attendant
- Basic Tourism and Conference Management
- Basic Travel/Tourism
- Homeland Transportation Security Certificate
- UAV/UAS Basic
- UAV/UAS Advanced

Career and Degree Path Program Options:**Airline Customer Services Career/Degree Path:**

- A.S. Degree Airline Customer Services
(Adv. Certificate + GE = 60 units)
- Advanced Airline Customer Services Certificate (35 units)
- Basic Airline Customer Services Certificate (15 units)

Aviation Management Career/Degree Path:

- A.S. Degree Aviation Management
(Adv. Certificate + GE = 60 units)
- Aviation Management Certificate (35 units)

Commercial Pilot Career/Degree Path:

- A.S. Degree Commercial Pilot
(Aviation IV - Advanced Pilot + GE = 61 units)
- Aviation I — Private Pilot (17-18 units)
- Aviation II — Instrument Pilot (24-26 units)
- Aviation III — Commercial Pilot (31-34 units)
- Aviation IV — Advanced Pilot (35 units)

Flight Attendant Career/Degree Path:

- A.S. Degree Flight Attendant (Adv. Certificate + GE = 60 units)
- Advanced Flight Attendant Certificate (35 units)
- Basic Flight Attendant Certificate (15 units)

Travel/Tourism Career/Degree Path:

- A.S. Degree Travel/Tourism (Adv. Certificate + GE = 60 units)
- Advanced Travel/Tourism Certificate (35 units)
- Basic Travel/Tourism Certificate (15 units)

Ancillary Certificates: Most of the courses required for the ancillary certificates may be applied to one or more of the above degrees.

- Basic Cruise Line Sales and Operations (15 units)
- Basic Tourism and Conference Management (15 units)
- Homeland Transportation Security Certificate (15 units)

Students are encouraged to meet with a counselor early in their program studies to optimize their schedules and to reduce the time it takes to complete a program. Students may dual major.

ASSOCIATE IN SCIENCE DEGREE AIRLINE CUSTOMER SERVICES Program Code: 1S14040

The Airline Customer Services Program provides students with a career path for attaining the communication skills, practical knowledge, and technical training necessary for pursuing a career as a reservations agent, gate agent, ticket agent, or customer services manager. Students completing this degree will develop an advanced understanding of the airline industry and the safety, security, and service requirements necessary to work in customer services for a major airline.

To earn an Associate Degree students must complete: (1) all major course requirements with a minimum grade of “C”; (2) 25 units of General Education Graduation Requirements; (3) the cultural diversity and reading requirements; (4) any elective courses to complete a minimum of 60 units; and, (5) have a minimum GPA of 2.0. At least 50% of all major course work must be completed at Cypress College. Courses that fulfill major requirements for an Associate Degree at Cypress College might not be the same as those required for completing the major at a transfer institution offering a Baccalaureate Degree. For information on specific university requirements, please consult with your counselor, or visit the Transfer Center.

| Required courses are listed in numeric sequence: | | Units |
|---|--------------------------------|--------------|
| ATC 101 C | Introduction to Travel Careers | 3 |
| ATC 102 C | Career Communication/Portfolio | 3 |
| ATC 174 C | Destinations: Americas/Europe | 3 |
| ATC 175 C | Destinations: Africa/Pacific | 3 |
| ATC 182 C | Cultural Tourism | 3 |
| | or | |
| ATC 256 C | Crew Resource Management | (3) |
| ATC 183 C | Customer Care: Airline/Travel | 3 |
| | or | |
| ATC 274 C | Passenger Services and Safety | (3) |
| ATC 192 C | Airline Reservations: SABRE | 3 |
| ATC 270 C | Airline Operations | 3 |

| Electives: To complete all major course requirements, students must complete 11 elective units from the list below (if not already taken as a required course) for a total of 35 units. | | Units |
|--|----------------------------------|--------------|
| ATC 112 C | Homeland Security | 3 |
| ATC 116 C | Aviation/Transportation Security | 3 |
| ATC 118 C | Disaster Preparedness/Response | 3 |
| ATC 132 C | Private Pilot | 4 |
| ATC 182 C | Cultural Tourism | 3 |
| ATC 183 C | Customer Care: Airline/Travel | 3 |
| ATC 196 C | Flight Simulator Private Pilot | 1 |
| ATC 256 C | Crew Resource Management | 3 |
| ATC 274 C | Passenger Services and Safety | 3 |
| ATC 278 C | Public Relations | 3 |
| ATC 295 C | Aviation/Travel Internship | 3 |
| ATC 298 C | Aviation/Travel Seminar | 0.5–12 |
| ATC 299 C | Independent Study | 0.5–2 |
| Total Units Required | | 35 |

ADVANCED AIRLINE CUSTOMER SERVICES CERTIFICATE Program Code: 1C21124

The Airline Customer Services Program provides students with a career path for attaining the communication skills, practical knowledge, and technical training necessary for pursuing a career as a reservations agent, gate agent, ticket agent, or customer services manager. Students completing this certificate will develop an advanced understanding of the airline industry and the safety, security, and service requirements necessary to work in customer services for a major airline.

To earn this certificate, complete the required courses as listed with a minimum grade of “C.” At least 50% of all major course work must be completed at Cypress College.

| Required courses are listed in numeric sequence: | | Units |
|---|--------------------------------|--------------|
| ATC 101 C | Introduction to Travel Careers | 3 |
| ATC 102 C | Career Communication/Portfolio | 3 |
| ATC 174 C | Destinations: Americas/Europe | 3 |
| ATC 175 C | Destinations: Africa/Pacific | 3 |
| ATC 182 C | Cultural Tourism | 3 |
| | or | |
| ATC 256 C | Crew Resource Management | (3) |
| ATC 183 C | Customer Care: Airline/Travel | 3 |
| | or | |
| ATC 274 C | Passenger Services and Safety | (3) |
| ATC 192 C | Airline Reservations: SABRE | 3 |
| ATC 270 C | Airline Operations | 3 |

| Electives: To complete all major course requirements, students must complete 11 elective units from the list below (if not already taken as a required course) for a total of 35 units. | | Units |
|--|----------------------------------|--------------|
| ATC 112 C | Homeland Security | 3 |
| ATC 116 C | Aviation/Transportation Security | 3 |
| ATC 118 C | Disaster Preparedness/Response | 3 |
| ATC 132 C | Private Pilot | 4 |
| ATC 182 C | Cultural Tourism | 3 |
| ATC 183 C | Customer Care: Airline/Travel | 3 |
| ATC 196 C | Flight Simulator Private Pilot | 1 |
| ATC 256 C | Crew Resource Management | 3 |
| ATC 274 C | Passenger Services and Safety | 3 |
| ATC 278 C | Public Relations | 3 |
| ATC 295 C | Aviation/Travel Internship | 3 |
| ATC 298 C | Aviation/Travel Seminar | 0.5–12 |
| ATC 299 C | Independent Study | 0.5–2 |
| Total Units Required | | 35 |

BASIC AIRLINE CUSTOMER SERVICES CERTIFICATE

Program Code: 1C14403

The Airline Customer Services Program provides students with a career path for attaining the communication skills, practical knowledge, and technical training necessary for pursuing a career as a reservations agent, gate agent, ticket agent, or customer services manager. Students completing this degree will develop a basic understanding of the airline industry and the safety, security, and service requirements necessary to work in customer services for a major airline.

To earn this certificate, complete the required courses as listed with a minimum grade of "C." At least 50% of all major course work must be completed at Cypress College.

| Required courses are listed in numeric sequence: | | Units |
|--|--------------------------------|-----------|
| ATC 101 C | Introduction to Travel Careers | 3 |
| ATC 102 C | Career Communication/Portfolio | 3 |
| ATC 174 C | Destinations: Americas/Europe | 3 |
| | or | |
| ATC 175 C | Destinations: Africa/Pacific | (3) |
| ATC 192 C | Airline Reservations: SABRE | 3 |
| ATC 270 C | Airline Operations | 3 |
| Total Units Required | | 15 |

ASSOCIATE IN SCIENCE DEGREE

AVIATION MANAGEMENT

Program Code: 1S03772

The Aviation Management Program provides students with a career path for attaining the foundational skills, practical knowledge, and technical training for pursuing a career in aviation management. Students completing this degree will develop advanced understanding of the safety, security, service, and regulatory requirements necessary to work in aviation management.

To earn an Associate Degree students must complete all graduation requirements to include: (1) all major course requirements with a minimum grade of "C" or better; (2) 25 units of General Education Graduation Requirements; (3) the cultural diversity and reading requirements; (4) any elective courses to complete a minimum of 60 units; and, (5) have a minimum GPA of 2.0. At least 50% of all major course work must be completed at Cypress College. Courses that fulfill major requirements for an Associate Degree at Cypress College might not be the same as those required for completing the major at a transfer institution offering a Baccalaureate Degree. For information on specific university requirements, please consult with your counselor, or visit the Transfer Center.

| Required courses are listed in suggested sequence: | | Units |
|--|----------------------------------|-------|
| ATC 102 C | Career Communication/Portfolio | 3 |
| ATC 104 C | Air Transportation | 3 |
| | or | |
| ATC 270 C | Airline Operations | (3) |
| ATC 112 C | Homeland Security | 3 |
| ATC 116 C | Aviation/Transportation Security | 3 |
| | or | |
| ATC 256 C | Crew Resource Management | (3) |
| ATC 118 C | Disaster Preparedness/Response | 3 |
| | or | |
| ATC 274 C | Passenger Services and Safety | (3) |
| ATC 132 C | Private Pilot | 4 |
| | or | |
| ATC 271 C | Airport Operations | (3) |
| ATC 182 C | Cultural Tourism | 3 |
| | or | |
| ATC 183 C | Customer Care: Airline/Travel | (3) |
| ATC 212 C | Airline/Aviation Management | 3 |

Electives: To complete all major course requirements, students must complete 11 elective units from the list below (if not already taken as a required course) for a total of 35 units.

| | Units | |
|-----------------------------|----------------------------------|-----------|
| ATC 100 C | Introduction to Aviation | 3 |
| ATC 116 C | Aviation/Transportation Security | 3 |
| ATC 123 C | Travel Sales and Tour Operations | 3 |
| ATC 126 C | Travel Management | 3 |
| ATC 132 C | Private Pilot | 4 |
| ATC 136 C | Air Navigation | 3 |
| ATC 140 C | Meteorology | 3 |
| ATC 180 C | Tourism/Conference Management | 3 |
| ATC 192 C | Airline Reservations: SABRE | 3 |
| ATC 196 C | Flight Simulator Private Pilot | 1 |
| ATC 240 C | Commercial Pilot Seminar | 3 |
| ATC 256 C | Crew Resource Management | 3 |
| ATC 274 C | Passenger Services and Safety | 3 |
| ATC 278 C | Public Relations | 3 |
| ATC 295 C | Aviation/Travel Internship | 3 |
| ATC 298 C | Aviation/Travel Seminar | .5–12 |
| ATC 299 C | Independent Study | 0.5–2 |
| Total Units Required | | 35 |

AVIATION MANAGEMENT

CERTIFICATE

Program Code: 1C31187

The Aviation Management Program provides students with a career path for attaining the foundational skills, practical knowledge, and technical training necessary for pursuing a career in aviation management. Students completing this certificate will develop an advanced understanding of the safety, security, service and regulatory requirements necessary to work in aviation management.

To earn this certificate, complete the required courses with a minimum grade of "C." At least 50% of all course work must be completed at Cypress College.

| Required courses are listed in suggested sequence: | | Units |
|--|----------------------------------|-------|
| ATC 102 C | Career Communication/Portfolio | 3 |
| ATC 104 C | Air Transportation | 3 |
| | or | |
| ATC 270 C | Airline Operations | (3) |
| ATC 112 C | Homeland Security | 3 |
| ATC 116 C | Aviation/Transportation Security | 3 |
| | or | |
| ATC 256 C | Crew Resource Management | (3) |
| ATC 118 C | Disaster Preparedness/Response | 3 |
| | or | |
| ATC 274 C | Passenger Services and Safety | (3) |
| ATC 132 C | Private Pilot | 4 |
| | or | |
| ATC 271 C | Airport Operations | (3) |
| ATC 182 C | Cultural Tourism | 3 |
| | or | |
| ATC 183 C | Customer Care: Airline/Travel | (3) |
| ATC 212 C | Airline/Aviation Management | 3 |

Electives: To complete all major course requirements, students must complete 10–11 elective units from the list below (if not already taken as a required course) for a total of 35 units.

| | Units |
|-----------------------------|-----------|
| ATC 100 C | 3 |
| ATC 116 C | 3 |
| ATC 123 C | 3 |
| ATC 126 C | 3 |
| ATC 132 C | 4 |
| ATC 136 C | 3 |
| ATC 140 C | 3 |
| ATC 180 C | 3 |
| ATC 192 C | 3 |
| ATC 196 C | 1 |
| ATC 240 C | 3 |
| ATC 256 C | 3 |
| ATC 274 C | 3 |
| ATC 278 C | 3 |
| ATC 295 C | 3 |
| ATC 298 C | 0.5–12 |
| ATC 299 C | 0.5–2 |
| Total Units Required | 35 |

**ASSOCIATE IN SCIENCE DEGREE
COMMERCIAL PILOT Program Code: 1S03773**

This curriculum is designed to prepare students to fly commercial, executive, and/or light aircraft as a pilot or instructor. To earn an Associate Degree students must complete: (1) all major course requirements with a minimum grade of “C”; (2) 25 units of General Education Graduation Requirements; (3) the cultural diversity and reading requirements; (4) any elective courses to complete a minimum of 60 units; and, (5) have a minimum GPA of 2.0. At least 50% of all major course work must be completed at Cypress College. Courses that fulfill major requirements for an Associate Degree at Cypress College might not be the same as those required for completing the major at a transfer institution offering a Baccalaureate Degree. For information on specific university requirements, please consult with your counselor, or visit the Transfer Center.

Required courses are listed in suggested sequence:

| | Units |
|-----------|-------|
| ATC 102 C | 3 |
| ATC 104 C | 3 |
| or | |
| ATC 270 C | (3) |
| ATC 132 C | 4 |
| ATC 136 C | 3 |
| ATC 140 C | 3 |
| ATC 144 C | 3 |
| ATC 196 C | 1 |
| or | |
| ATC 190 C | (2) |
| ATC 197 C | 1 |
| or | |
| ATC 194 C | (2) |
| ATC 198 C | 1 |
| or | |
| ATC 195 C | (2) |
| ATC 232 C | 3 |
| ATC 240 C | 3 |
| ATC 256 C | 3 |

Electives: To complete all major course requirements, students must complete 1–4 elective units from the list below (if not already taken as a required course) for a total of 35 units.

| | Units |
|-----------------------------|-----------|
| ATC 152 C | 3 |
| ATC 189 C | 0.5 |
| ATC 190 C | 2 |
| ATC 193 C | 1–5 |
| ATC 194 C | 2 |
| ATC 195 C | 2 |
| ATC 197 C | 1 |
| ATC 198 C | 1 |
| ATC 199 C | 1 |
| ATC 212 C | 3 |
| ATC 244 C | 3 |
| ATC 250 C | 0.5 |
| ATC 255 C | 0.5 |
| ATC 295 C | 3 |
| ATC 298 C | 0.5–12 |
| ATC 299 C | 0.5–2 |
| Total Units Required | 35 |

**AVIATION I — PRIVATE PILOT
CERTIFICATE Program Code: 1C22916**

This certificate provides students who have begun flying with the basic background and knowledge to gain entry-level employment in the Aviation Industry in areas such as line service and fueling.

To earn a certificate, complete the required courses with a minimum grade of “C.” At least 50% of all course work must be completed at Cypress College.

Required courses are listed in suggested sequence:

| | Units |
|-----------------------------|--------------|
| ATC 102 C | 3 |
| ATC 104 C | 3 |
| or | |
| ATC 270 C | (3) |
| ATC 132 C | 4 |
| ATC 140 C | 3 |
| ATC 144 C | 3 |
| ATC 196 C | 1 |
| or | |
| ATC 190 C | (2) |
| Total Units Required | 17–18 |

AVIATION II — INSTRUMENT PILOT CERTIFICATE **Program Code: 1C22917**

This certificate provides students with the necessary background to gain employment in the aviation industry requiring knowledge of weather, navigation and instrument flight such as flight scheduling and general aviation dispatching.

To earn a certificate, complete the required courses with a minimum grade of “C.” At least 50% of all course work must be completed at Cypress College.

| Required courses are listed in suggested sequence: | | Units |
|---|-----------------------------------|--------------|
| ATC 102 C | Career Communication/Portfolio | 3 |
| ATC 104 C | Air Transportation | 3 |
| | or | |
| ATC 270 C | Airline Operations | (3) |
| ATC 132 C | Private Pilot | 4 |
| ATC 136 C | Air Navigation | 3 |
| ATC 140 C | Meteorology | 3 |
| ATC 144 C | Aircraft and Engines | 3 |
| ATC 196 C | Flight Simulator Private Pilot | 1 |
| | or | |
| ATC 190 C | Flight Training — Private Pilot | (2) |
| ATC 197 C | Flight Simulator Instrument | 1 |
| | or | |
| ATC 194 C | Flight Training Instrument Rating | (2) |
| ATC 232 C | Instrument Rating | 3 |
| | Total Units Required | 24–26 |

AVIATION III — COMMERCIAL PILOT CERTIFICATE **Program Code: 1C22918**

This certificate prepares students for entry into the commercial pilot profession. To earn a certificate, complete the required courses with a minimum grade of “C.” At least 50% of all course work must be completed at Cypress College.

| Required courses are listed in suggested sequence: | | Units |
|---|-----------------------------------|--------------|
| ATC 102 C | Career Communication/Portfolio | 3 |
| ATC 104 C | Air Transportation | 3 |
| | or | |
| ATC 270 C | Airline Operations | (3) |
| ATC 132 C | Private Pilot | 4 |
| ATC 136 C | Air Navigation | 3 |
| ATC 140 C | Meteorology | 3 |
| ATC 144 C | Aircraft and Engines | 3 |
| ATC 196 C | Flight Simulator Private Pilot | 1 |
| | or | |
| ATC 190 C | Flight Training — Private Pilot | (2) |
| ATC 197 C | Flight Simulator Instrument | 1 |
| | or | |
| ATC 194 C | Flight Training Instrument Rating | (2) |
| ATC 198 C | Flight Simulator Commercial | 1 |
| | or | |
| ATC 195 C | Flight Training Commercial Pilot | (2) |
| ATC 232 C | Instrument Rating | 3 |
| ATC 240 C | Commercial Pilot Seminar | 3 |
| ATC 256 C | Crew Resource Management | 3 |
| | Total Units Required | 31–34 |

AVIATION IV — ADVANCED PILOT CERTIFICATE **Program Code: 1C22919**

This certificate prepares students for entry into the aviation/air transportation industry as a professional pilot.

To qualify for this certificate, students must have completed all of the required courses listed below and four (4) units from the list of electives.

To earn a certificate, complete the required courses with a minimum grade of “C.” At least 50% of all course work must be completed at Cypress College.

| Required courses are listed in suggested sequence: | | Units |
|---|-----------------------------------|--------------|
| ATC 102 C | Career Communication/Portfolio | 3 |
| ATC 104 C | Air Transportation | 3 |
| | or | |
| ATC 270 C | Airline Operations | (3) |
| ATC 132 C | Private Pilot | 4 |
| ATC 136 C | Air Navigation | 3 |
| ATC 140 C | Meteorology | 3 |
| ATC 144 C | Aircraft and Engines | 3 |
| ATC 196 C | Flight Simulator Private Pilot | 1 |
| | or | |
| ATC 190 C | Flight Training — Private Pilot | (2) |
| ATC 197 C | Flight Simulator Instrument | 1 |
| | or | |
| ATC 194 C | Flight Training Instrument Rating | (2) |
| ATC 198 C | Flight Simulator Commercial | 1 |
| | or | |
| ATC 195 C | Flight Training Commercial Pilot | (2) |
| ATC 232 C | Instrument Rating | 3 |
| ATC 240 C | Commercial Pilot Seminar | 3 |
| ATC 256 C | Crew Resource Management | 3 |

Electives: To complete all major course requirements, students must complete 1 to 4 elective units from the list below (if not already taken as a required course) for a total of 35 units.

| | Units | |
|-----------|---------------------------------------|-----------|
| ATC 152 C | Glider Pilot | 3 |
| ATC 189 C | Flight Training Device — Introduction | 0.5 |
| ATC 190 C | Flight Training — Private Pilot | 2 |
| ATC 193 C | Flight Training — Flight Instructor | 1–5 |
| ATC 194 C | Flight Training Instrument Rating | 2 |
| ATC 195 C | Flight Training Commercial Pilot | 2 |
| ATC 196 C | Flight Simulator Private Pilot | 1 |
| ATC 197 C | Flight Simulator Instrument | 1 |
| ATC 198 C | Flight Simulator Commercial | 1 |
| ATC 199 C | Flight Simulator Instructor | 1 |
| ATC 212 C | Airline/Aviation Management | 3 |
| ATC 244 C | Aviation Instructor | 3 |
| ATC 250 C | Turbine Simulator Observation | 0.5 |
| ATC 255 C | Turbine Simulator Orientation | 0.5 |
| ATC 295 C | Aviation/Travel Internship | 3 |
| ATC 298 C | Aviation/Travel Seminar | 0.5–12 |
| ATC 299 C | Independent Study | 0.5–2 |
| | Total Units Required | 35 |

ASSOCIATE IN SCIENCE DEGREE

UAV/UAS

Program Code: 1A35448

This program prepares students to meet the Federal Aviation Administration requirements to operate lightweight and heavier Unmanned Aircraft Vehicles (UAVs) in commercial operations, utilizing Unmanned Aircraft Systems (UAS). To earn an Associate Degree students must complete: (1) all major course requirements with a minimum grade of “C”; (2) 25 units of General Education Graduation Requirements; (3) the cultural diversity and reading requirements; (4) any elective courses to complete a minimum of 60 units; and, (5) have a minimum GPA of 2.0. At least 50% of all major course work must be completed at Cypress College. Courses that fulfill major requirements for an Associate Degree at Cypress College might not be the same as those required for completing the major at a transfer institution offering a Baccalaureate Degree. For information on specific university requirements, please consult with your counselor, or visit the Transfer Center.

| Required courses are listed in numeric sequence: | | Units |
|---|--------------------------------|--------------|
| ATC 102 C | Career Communication/Portfolio | 3 |
| ATC 132 C | Private Pilot | 4 |
| ATC 136 C | Air Navigation | 3 |
| ATC 140 C | Meteorology | 3 |
| ATC 144 C | Aircraft and Engines | 3 |
| ATC 160 C | UAV/UAS Basic | 3 |
| ATC 161 C | UAV/UAS Basic Simulator | 1 |
| ATC 162 C | UAV/UAS Basic Flight | 2 |
| ATC 197 C | Flight Simulator Instrument | 1 |
| ATC 232 C | Instrument Rating | 3 |
| ATC 256 C | Crew Resource Management | 3 |
| ATC 260 C | UAV/UAS Advanced | 3 |
| ATC 261 C | UAV/UAS Advanced Simulator | 1 |
| ATC 262 C | UAV/UAS Advanced Flight | 2 |
| Total Units | | 35 |

UAV/UAS BASIC CERTIFICATE

Program Code: 1C35422

This certificate prepares students to meet the Federal Aviation Administration requirements to operate lightweight Unmanned Aircraft Vehicles (UAVs) in commercial operations, utilizing Unmanned Aircraft Systems (UAS). To earn this certificate, complete the required courses as listed with a minimum grade of “C.” At least 50% of all major course work must be completed at Cypress College.

| Required courses are listed in numeric sequence: | | Units |
|---|--------------------------------|--------------|
| ATC 102 C | Career Communication/Portfolio | 3 |
| ATC 132 C | Private Pilot | 4 |
| ATC 136 C | Air Navigation | 3 |
| ATC 160 C | UAV/UAS Basic | 3 |
| ATC 161 C | UAV/UAS Basic Simulator | 1 |
| ATC 162 C | UAV/UAS Basic Flight | 2 |
| Total Units | | 16 |

UAV/UAS ADVANCED CERTIFICATE

Program Code: 1C35423

This certificate prepares students to meet the Federal Aviation Administration requirements to operate lightweight and heavier Unmanned Aircraft Vehicles (UAVs) in commercial operations, utilizing Unmanned Aircraft Systems (UAS). To earn this certificate, complete the required courses as listed with a minimum grade of “C.” At least 50% of all major course work must be completed at Cypress College.

| Required courses are listed in numeric sequence: | | Units |
|---|--------------------------------|--------------|
| ATC 102 C | Career Communication/Portfolio | 3 |
| ATC 132 C | Private Pilot | 4 |
| ATC 136 C | Air Navigation | 3 |
| ATC 140 C | Meteorology | 3 |
| ATC 144 C | Aircraft and Engines | 3 |
| ATC 160 C | UAV/UAS Basic | 3 |
| ATC 161 C | UAV/UAS Basic Simulator | 1 |
| ATC 162 C | UAV/UAS Basic Flight | 2 |
| ATC 197 C | Flight Simulator Instrument | 1 |
| ATC 232 C | Instrument Rating | 3 |
| ATC 256 C | Crew Resource Management | 3 |
| ATC 260 C | UAV/UAS Advanced | 3 |
| ATC 261 C | UAV/UAS Advanced Simulator | 1 |
| ATC 262 C | UAV/UAS Advanced Flight | 2 |
| Total Units | | 35 |

ASSOCIATE IN SCIENCE DEGREE

FLIGHT ATTENDANT

Program Code: 1S03814

The Flight Attendant Program provides students with a career path for attaining the communication skills, practical knowledge, and technical training necessary for pursuing a career as a flight attendant. Students completing this degree will develop an advanced understanding of the airline industry and the customer safety, security, and service requirements necessary to work as a flight attendant for a major airline.

To earn an Associate Degree students must complete: (1) all major course requirements with a minimum grade of “C”; (2) 25 units of General Education Graduation Requirements; (3) the cultural diversity and reading requirements; (4) any elective courses to complete a minimum of 60 units; and, (5) have a minimum GPA of 2.0. At least 50% of all major course work must be completed at Cypress College. Courses that fulfill major requirements for an Associate Degree at Cypress College might not be the same as those required for completing the major at a transfer institution offering a Baccalaureate Degree. For information on specific university requirements, please consult with your counselor, or visit the Transfer Center.

| Required courses are listed in suggested sequence: | | Units |
|---|--------------------------------|--------------|
| ATC 101 C | Introduction to Travel Careers | 3 |
| ATC 102 C | Career Communication/Portfolio | 3 |
| ATC 174 C | Destinations: Americas/Europe | 3 |
| ATC 175 C | Destinations: Africa/Pacific | 3 |
| ATC 182 C | Cultural Tourism | 3 |
| ATC 183 C | Customer Care: Airline/Travel | 3 |
| ATC 256 C | Crew Resource Management | 3 |
| ATC 270 C | Airline Operations | 3 |
| ATC 274 C | Passenger Services and Safety | 3 |

Electives: To complete all major course requirements, students must complete 8 elective units from the list below for a total of 35 units.

| | Units | |
|-----------------------------|----------------------------------|-----------|
| ATC 100 C | Introduction to Aviation | 3 |
| ATC 112 C | Homeland Security | 3 |
| ATC 116 C | Aviation/Transportation Security | 3 |
| ATC 118 C | Disaster Preparedness/Response | 3 |
| ATC 132 C | Private Pilot | 4 |
| ATC 196 C | Flight Simulator Private Pilot | 1 |
| ATC 278 C | Public Relations | 3 |
| ATC 295 C | Aviation/Travel Internship | 3 |
| ATC 298 C | Aviation/Travel Seminar | 0.5–12 |
| ATC 299 C | Independent Study | 0.5–2 |
| PE 170 C | Self Defense | 0.5–1 |
| PE 235 C | First Aid, CPR and Emergencies | 3 |
| Total Units Required | | 35 |

ADVANCED FLIGHT ATTENDANT CERTIFICATE **Program Code: 1C21126**

The Flight Attendant Program provides students with a career path for attaining the communication skills, practical knowledge, and technical training necessary for pursuing a career as a flight attendant. Students completing this certificate will develop an advanced understanding of the airline industry and the customer safety, security, and service requirements necessary to work as a flight attendant for a major airline.

To earn this certificate, complete the required courses as listed with a minimum grade of “C.” At least 50% of all major course work must be completed at Cypress College.

| Required courses are listed in suggested sequence: | Units | |
|--|--------------------------------|---|
| ATC 101 C | Introduction to Travel Careers | 3 |
| ATC 102 C | Career Communication/Portfolio | 3 |
| ATC 174 C | Destinations: Americas/Europe | 3 |
| ATC 175 C | Destinations: Africa/Pacific | 3 |
| ATC 182 C | Cultural Tourism | 3 |
| ATC 183 C | Customer Care: Airline/Travel | 3 |
| ATC 256 C | Crew Resource Management | 3 |
| ATC 270 C | Airline Operations | 3 |
| ATC 274 C | Passenger Services and Safety | 3 |

Electives: To complete all major course requirements, students must complete 8 elective units from the list below for a total of 35 units.

| | Units | |
|-----------------------------|----------------------------------|-----------|
| ATC 100 C | Introduction to Aviation | 3 |
| ATC 112 C | Homeland Security | 3 |
| ATC 116 C | Aviation/Transportation Security | 3 |
| ATC 118 C | Disaster Preparedness/Response | 3 |
| ATC 132 C | Private Pilot | 4 |
| ATC 196 C | Flight Simulator Private Pilot | 1 |
| ATC 278 C | Public Relations | 3 |
| ATC 295 C | Aviation/Travel Internship | 3 |
| ATC 298 C | Aviation/Travel Seminar | 0.5–12 |
| ATC 299 C | Independent Study | 0.5–2 |
| PE 170 C | Self Defense | 0.5–1 |
| PE 235 C | First Aid, CPR and Emergencies | 3 |
| Total Units Required | | 35 |

BASIC AIRPORT OPERATIONS CERTIFICATE **Program Code: 1C33734**

The Airport Operations Program provides students with a career path for attaining the foundational skills, practical knowledge, and technical training necessary for pursuing a career as an operations, baggage, or cargo agent, or as an airport operations employee. Students completing this certificate will develop a basic understanding of the airline industry and the safety, security, and service requirements necessary to work in ground operations at an airport. To earn this certificate, complete the required courses as listed with a minimum grade of “C.” At least 50% of all major course work must be completed at Cypress College.

| Required courses are listed in numeric sequence: | Units | |
|--|----------------------------------|-----------|
| ATC 102 C | Career Communication/Portfolio | 3 |
| ATC 112 C | Homeland Security | 3 |
| | or | |
| ATC 116 C | Aviation/Transportation Security | (3) |
| ATC 212 C | Airline/Aviation Management | 3 |
| ATC 270 C | Airline Operations | 3 |
| ATC 271 C | Airport Operations | 3 |
| Total Units Required | | 15 |

BASIC FLIGHT ATTENDANT CERTIFICATE **Program Code: 1C14404**

The Flight Attendant Program provides students with a career path for attaining the communication skills, practical knowledge, and technical training necessary for pursuing a career as a flight attendant. Students completing this certificate will develop a basic understanding of the airline industry and the customer safety, security, and service requirements necessary to work as a flight attendant for a major airline.

To earn this certificate, complete the required courses as listed with a minimum grade of “C.” At least 50% of all major course work must be completed at Cypress College.

| Required courses are listed in numeric sequence: | Units | |
|--|--------------------------------|-----------|
| ATC 101 C | Introduction to Travel Careers | 3 |
| ATC 102 C | Career Communication/Portfolio | 3 |
| ATC 174 C | Destinations: Americas/Europe | 3 |
| | or | |
| ATC 175 C | Destinations: Africa/Pacific | (3) |
| ATC 183 C | Customer Care: Airline/Travel | 3 |
| | or | |
| ATC 274 C | Passenger Services and Safety | (3) |
| ATC 270 C | Airline Operations | 3 |
| Total Units Required | | 15 |

ASSOCIATE IN SCIENCE DEGREE

TRAVEL/TOURISM

Program Code: 1S07859

The Travel and Tourism Program provides students with a career path for attaining the communication skills, practical knowledge, and technical training necessary for pursuing a career as a travel agent, tour guide, or corporate travel consultant. Students completing this degree will develop an advanced understanding of the travel industry and the sales, security, and service requirements necessary to work in the travel industry.

To earn an Associate Degree students must complete: (1) all major course requirements with a minimum grade of “C”; (2) 25 units of General Education Graduation Requirements; (3) the cultural diversity and reading requirements; (4) any elective courses to complete a minimum of 60 units; and, (5) have a minimum GPA of 2.0. At least 50% of all major course work must be completed at Cypress College. Courses that fulfill major requirements for an Associate Degree at Cypress College might not be the same as those required for completing the major at a transfer institution offering a Baccalaureate Degree. For information on specific university requirements, please consult with your counselor, or visit the Transfer Center.

| Required courses are listed in suggested sequence: | | Units |
|---|----------------------------------|--------------|
| ATC 101 C | Introduction to Travel Careers | 3 |
| ATC 102 C | Career Communication/Portfolio | 3 |
| ATC 123 C | Travel Sales and Tour Operations | 3 |
| ATC 126 C | Travel Management | 3 |
| | or | |
| ATC 212 C | Airline/Aviation Management | (3) |
| ATC 174 C | Destinations: Americas/Europe | 3 |
| ATC 175 C | Destinations: Africa/Pacific | 3 |
| ATC 182 C | Cultural Tourism | 3 |
| ATC 192 C | Airline Reservations: SABRE | 3 |
| ATC 223 C | Cruise Line Sales and Operations | 3 |

Electives: To complete all major course requirements, students must complete 8 elective units from the list below for a total of 35 units.

| | Units |
|-----------|------------------------------------|
| ATC 112 C | Homeland Security 3 |
| ATC 116 C | Aviation/Transportation Security 3 |
| ATC 180 C | Tourism/Conference Management 3 |
| ATC 183 C | Customer Care: Airline/Travel 3 |
| ATC 278 C | Public Relations 3 |
| ATC 295 C | Aviation/Travel Internship 3 |
| ATC 298 C | Aviation/Travel Seminar 0.5–12 |
| ATC 299 C | Independent Study 0.5–2 |
| | Total Units Required 35 |

ADVANCED TRAVEL/TOURISM

CERTIFICATE

Program Code: 1C21123

The Travel and Tourism Program provides students with a career path for attaining the communication skills, practical knowledge, and technical training necessary for pursuing a career as a travel agent, tour guide, or corporate travel consultant. Students completing this certificate will develop an advanced understanding of the travel industry and the sales, security, and service requirements necessary to work in the travel industry.

To earn this certificate, complete the required courses as listed with a minimum grade of “C.” At least 50% of all major course work must be completed at Cypress College.

| Required courses are listed in suggested sequence: | | Units |
|---|----------------------------------|--------------|
| ATC 101 C | Introduction to Travel Careers | 3 |
| ATC 102 C | Career Communication/Portfolio | 3 |
| ATC 123 C | Travel Sales and Tour Operations | 3 |
| ATC 126 C | Travel Management | 3 |
| | or | |
| ATC 212 C | Airline/Aviation Management | (3) |
| ATC 174 C | Destinations: Americas/Europe | 3 |
| ATC 175 C | Destinations: Africa/Pacific | 3 |
| ATC 182 C | Cultural Tourism | 3 |
| ATC 192 C | Airline Reservations: SABRE | 3 |
| ATC 223 C | Cruise Line Sales and Operations | 3 |

Electives: To complete all major course requirements, students must complete 8 elective units from the list below for a total of 35 units.

| | Units |
|-----------|------------------------------------|
| ATC 112 C | Homeland Security 3 |
| ATC 116 C | Aviation/Transportation Security 3 |
| ATC 180 C | Tourism/Conference Management 3 |
| ATC 183 C | Customer Care: Airline/Travel 3 |
| ATC 278 C | Public Relations 3 |
| ATC 295 C | Aviation/Travel Internship 3 |
| ATC 298 C | Aviation/Travel Seminar 0.5–12 |
| ATC 299 C | Independent Study 0.5–2 |
| | Total Units Required 35 |

BASIC TRAVEL/TOURISM

CERTIFICATE

Program Code: 1C14405

The Travel and Tourism Program provides students with a career path for attaining the communication skills, practical knowledge, and technical training necessary for pursuing a career as a travel agent, tour guide, or corporate travel consultant. Students completing this certificate will develop a basic understanding of the travel industry and the sales, security, and service requirements necessary to work in the travel industry.

To earn a Travel/Tourism Certificate, students must complete the required courses with a minimum grade of “C.” At least 50% of all course work must be completed at Cypress College.

| Required courses are listed in suggested sequence: | | Units |
|---|----------------------------------|--------------|
| Course # | Title | |
| ATC 101 C | Introduction to Travel Careers | 3 |
| ATC 102 C | Career Communication/Portfolio | 3 |
| ATC 123 C | Travel Sales and Tour Operations | 3 |
| ATC 174 C | Destinations: Americas/Europe | 3 |
| | or | |
| ATC 175 C | Destinations: Africa/Pacific | (3) |
| ATC 192 C | Airline Reservations: SABRE | 3 |
| | Total Units Required | 15 |

BASIC CRUISE LINE SALES AND OPERATIONS CERTIFICATE

Program Code: 1C30458

The Basic Cruise Line Sales and Operations Certificate provides students with a career path for attaining the communication skills, practical knowledge, and technical training necessary for pursuing a career in cruise line sales and operations. Students completing this certificate will develop a basic understanding of the cruise line operations and the sales, security, and service requirements necessary to work in the cruise industry.

To earn this certificate, complete the required courses as listed with a minimum grade of "C." At least 50% of all major course work must be completed at Cypress College.

Required courses are listed in numeric sequence:

| Course # | Title | Units |
|-----------------------------|-------------------------------------|-----------|
| ATC 101 C | Introduction to Travel Careers | 3 |
| ATC 102 C | Career Communication/Portfolio | 3 |
| ATC 123 C | Travel Sales and Tour Operations | 3 |
| ATC 174 C | Destinations: Americas/Europe or | 3 |
| ATC 175 C | Destinations: Africa/Pacific | (3) |
| ATC 223 C | Cruise Line Sales and Operations | 3 |
| Total Units Required | | 15 |

BASIC TOURISM AND CONFERENCE MANAGEMENT CERTIFICATE

Program Code: 1C17168

The Basic Tourism and Conference Management Certificate prepares students to work as professional meeting and event coordinators. The basic certificate will prepare the students for entry-level employment in the industry as an apprentice meeting and event coordinator.

To earn a certificate, students must complete the required courses with a minimum grade of "C." At least 50% of all course work must be completed at Cypress College.

Required courses are listed in suggested sequence:

| Course # | Title | Units |
|-----------------------------|-------------------------------------|-----------|
| ATC 101 C | Introduction to Travel Careers | 3 |
| ATC 102 C | Career Communication/Portfolio | 3 |
| ATC 123 C | Travel Sales and Tour Operations | 3 |
| ATC 180 C | Tourism/Conference Management | 3 |
| ATC 174 C | Destinations: Americas/Europe or | 3 |
| ATC 175 C | Destinations: Africa/Pacific | (3) |
| Total Units Required | | 15 |

HOMELAND TRANSPORTATION SECURITY CERTIFICATE

Program Code: 1C17169

The Homeland Transportation Security Certificate provides technical skills and in-depth knowledge relating to the homeland security, administration of justice, organizational protection, and safety with an emphasis on the travel and transportation industries.

To earn a certificate, students must complete the required courses with a minimum grade of "C." At least 50% of all course work must be completed at Cypress College.

Required courses are listed in suggested sequence:

| Course # | Title | Units |
|-----------------------------|--|-----------|
| AJ 110 C | Introduction to Criminal Justice or | 3 |
| AJ 120 C | Concepts of Criminal Law | (3) |
| ATC 102 C | Career Communication/Portfolio | 3 |
| ATC 112 C | Homeland Security | 3 |
| ATC 116 C | Aviation/Transportation Security or | 3 |
| ATC 256 C | Crew Resource Management | (3) |
| ATC 118 C | Disaster Preparedness/Response | 3 |
| ATC 274 C | Passenger Services and Safety | 3 |
| Total Units Required | | 18 |

Aviation and Travel Careers (ATC)

ATC 050 C Special Projects **2 Units**

Corequisite: Students must be enrolled in another Aviation and Travel Careers course.

Term hours: 18 lecture and 54 laboratory TBA. This course provides students with opportunities to practice aviation and travel related principles and procedures in practical situations and simulations to develop increased skills. May be taken for credit 2 times.

ATC 100 C Introduction to Aviation **3 Units**

Formerly AVIA 100 C

Term hours: 54 lecture. This course is a general introductory course covering the development of aviation and its importance in the economy. Special emphasis is placed on the history of aviation, the airlines and general aviation. (CSU)

ATC 101 C Introduction to Travel Careers **3 Units**

Advisory: Eligibility for ENGL 060 C or equivalent.

Term hours: 54 lecture. This course introduces students to career opportunities in the aviation and travel industries. Students will learn how to research and apply for jobs. The fundamentals of traveling will also be reviewed such as passport, visa, security, travel health and insurance. Students will prepare a personalized career project. (CSU)

ATC 102 C Career Communication - Portfolio **3 Units**

Term hours: 54 lecture. Students will develop their business communication skills in the development of a career portfolio, including a resume, cover letter, letters of recommendations, and work samples consistent with professional business conventions. Students will learn online application strategies, employment test-taking tips, and behavioral-based interviewing skills. (CSU)

ATC 103 C Aviation/Travel Open Lab 5 to 3 Units

Corequisite: Students must be enrolled in another ATC course.

Term hours: 24 to 162 laboratory depending on units attempted. This open entry, open exit course with flexible hours and variable units provides students enrolled in an Aviation & Travel Careers course with the equipment and resources to allow self-paced instruction and/or practice in core competencies. Twenty-four (24) hours are required for each one-half unit. May be taken for credit 4 times. Open Entry/Open Exit. \$5.00 Material Fee-Payable at Registration. (CSU)

ATC 104 C Air Transportation 3 Units

Formerly AVIA 104 C

Term hours: 54 lecture. This course presents the development and current status of aviation and the air transportation industry, including aircraft types, airport facilities, State and Federal regulations, security issues, economic challenges, career opportunities, and services of United States air carriers and the organization and function of the FAA, NTSB, IATA and ICAO. (CSU)

ATC 112 C Homeland Security 3 Units

Term hours: 54 lecture. This course is an introductory study of domestic and international threats of terrorism. It examines the concepts, definitions, and contemporary issues of modern terrorism. The course includes law enforcement issues for first-responders relating to terrorism, particularly with regard to Homeland Protection and counter terrorists measures. (CSU)

ATC 116 C Aviation/Transportation Security 3 Units

Term hours: 54 lecture. This course is an introductory study of domestic and international airport and transportation security issues. It includes the Patriot Act and changing laws relating to airport and transportation security. The course will present and analyze the current status of aviation law pertaining to terrorism, air rage, search and seizure protections and impending changes to the nation's transportation industry. (CSU)

ATC 118 C Disaster Preparedness/Response 3 Units

Term hours: 54 lecture. This course provides students with an awareness of natural and man-made incidents which result in catastrophic loss. Disaster scenarios will be examined from the perspective of preparedness, response and clean-up. Federal, state and local response preparedness programs will be a focus, including FEMA. Students will take part in simulated incidents, including safety and security for large-scale events. State and national incident command systems, S.E.M.S. and N.I.M.S., will be taught so as to familiarize the student to police and fire responses. (CSU)

ATC 123 C Travel Sales and Tour Operations 3 Units

Term hours: 54 lecture. Students will learn the essentials of travel sales and tour operations, including the latest trends, itinerary planning, and the technologies available to travel/tourism consultants in the leisure, recreational, and corporate travel markets. (CSU)

ATC 126 C Travel Management 3 Units

Term hours: 54 lecture. This course is a study of management practices in the airline and travel/tourism industries, including ARC requirements, location and staffing, sales reports and agency accounting. Travel markets, product lines, marketing techniques, advertising, and promotions are explored. Techniques for personal and telephone selling and guidelines for handling job stress, sales, and client crises are included. Students will learn supervisory and leadership strategies. (CSU)

ATC 132 C Private Pilot 4 Units

Formerly AVIA 132 C

Term hours: 54 lecture and 54 laboratory. This course provides students with an introduction to basic principles of aviation, meteorology, navigation, radio communication and Federal Aviation Regulations to qualify the student for the FAA Knowledge Examination for the Private Pilot Certificate and meets the FAA requirements for ground training. Pass/No Pass/Letter Grade Option. (CSU)

ATC 136 C Air Navigation 3 Units

Formerly AVIA 136 C

Prerequisite: Completion of or concurrent enrollment in ATC 132 C.

Term hours: 54 lecture. This course is a study of pilotage, dead reckoning, and radio navigation techniques; solution and application of navigation problems. This course meets partial fulfillment of the requirements of the FAA for ground training. (CSU)

ATC 140 C Meteorology 3 Units

Formerly AVIA 140 C

Prerequisite: Completion of or concurrent enrollment in ATC 132 C.

Term hours: 54 lecture. This is a course of study of weather recognition, icing, fog, fronts, clouds, weather maps and symbols, forecasting pressure patterns, wind systems, temperature-humidity-dew point relationships, precipitation, with emphasis on the practical application of this knowledge to safe flying practices. The services and assistance available from the U.S. Weather Bureau will be highlighted. The course meets the Meteorology requirements of the FAA for ground training. (CSU)

ATC 144 C Aircraft and Engines 3 Units

Formerly AVIA 144 C

Prerequisite: Completion of or concurrent enrollment in ATC 132 C.

Term hours: 54 lecture. This course is a study of the theory of flight, aircraft design, construction, operation limitations, repair and maintenance, maintenance records and aircraft accessories. Engine study includes principles of internal combustion engines, engine design and construction, fuel, lubrication and cooling systems, propellers, trouble shooting and preventive maintenance. This course meets partial fulfillment of the requirements of the FAA for ground training. (CSU)

ATC 152 C Glider Pilot 3 Units

Formerly AVIA 152 C

Term hours: 54 lecture. This is an introductory course in glider flying including the theory of flight, weather, Federal Aviation Regulations, as well as principles and techniques of cross country and competition flying. It prepares students for the FAA Private Pilot - Glider knowledge examination. (CSU)

ATC 160 C UAV/UAS Basic 3 Units

Term hours: 54 lecture. Prepares students to meet the Federal Aviation Administration requirements for certification to operate Unmanned Aircraft Vehicles (UAVs) under 55 pounds in commercial operations. Emphasizes the safety, legal, and ethical requirements of operation in the public, civil, commercial and military settings. Includes core technologies including optics, sensors, power plants, control systems and communication technologies. (CSU)

ATC 161 C UAV/UAS Basic Simulator 1 Unit

Advisory: Concurrent enrollment in or completion of ATC 160 C, UAV/UAS Basic.

Term hours: 18 lecture and 18 laboratory. Hands-on flight simulation activities to develop, practice, and optimize essential Unmanned Aircraft Systems pilot flight skills. Flight time in the approved ground trainers may be applied toward requirements for both attaining and maintaining flight ratings. (CSU)

ATC 162 C UAV/UAS Basic Flight 2 Units

Advisory: Completion of or concurrent enrollment in ATC 160 C and ATC 161 C.

Term hours: 18 lecture and 54 laboratory. Flight time in the approved UAV/UAS aircraft may be applied toward requirements for both attaining and maintaining flight ratings. (CSU)

ATC 174 C Destinations: Americas/Europe 3 Units

Term hours: 54 lecture. This course introduces students to world geography from a travel and tourism perspective. Students will learn about domestic and international travel considerations including itineraries, currencies, travel documents, customs, language, health requirements, and time considerations for locations throughout the Americas and Europe. (CSU)

ATC 175 C Destinations: Africa/Pacific 3 Units

Term hours: 54 lecture. This course continues the study of world geography from a travel and tourism perspective. Students will examine international travel considerations including itineraries, currencies, travel documents, customs, language, health requirements, and time considerations for the following locations: Africa, the Middle East, Asia, and the Pacific Islands. (CSU)

ATC 180 C Tourism/Conference Management 3 Units

Term hours: 54 lecture. This course is an introductory study of meeting, convention, and event planning. It introduces students to industry terminology, types of events and venues, needs assessments, program and budget development, and project coordination. (CSU)

ATC 182 C Cultural Tourism 3 Units

Advisory: Eligibility for ENGL 060 C or the equivalent writing skills.

Term hours: 54 lecture. This course examines the implications of cultural tourism in the United States. The course will consider the struggle of people to preserve their cultural identity relative to the role of the U.S. tourism industry in protecting cultural heritage, resources, and sites. The course promotes multicultural awareness, hospitality, and sensitivity as a means of recognizing others and minimizing the exploitation of their culture. The course explores the complexities and challenges of U.S. policy making and preservation in cultural tourism development. (CSU, CUL DIV)

ATC 183 C Customer Care: Airline/Travel 3 Units

Term hours: 54 lecture. This course examines the priority of customer service and satisfaction in the competitive airline industry. Topics include the safety regulations and service standards of the Federal Aviation Administration, the Department of Transportation, and airlines themselves. Students will study these standards in relation to current performance, public opinion, and service ideology. Students will also investigate how airlines differentiate their service to be competitive in a particular market niche. (CSU)

ATC 189 C Flight Training Device - Introduction .5 Units

Formerly AVIA 189 C

Term Hours: 27 laboratory. Students will receive a hands-on introduction to a PC-based Flight Training Device and become familiar with the fundamentals of flight, flight terminology, flight controls, and instrument interpretations. Pass/No Pass/Letter Grade Option. (CSU)

ATC 190 C Flight Training-Private Pilot 2 Units

Prerequisite: Students must provide substantiation of an FAA Private Pilot Certificate or concurrent enrollment in an approved flight training program working toward an FAA Private Pilot Certificate, and completion of or concurrent enrollment in at least 3 units of ATC (132 or above) with a "C" or higher grade.

Term hours: Hours as required by the FAA. Students who have earned, or are enrolled in an approved flight school and will earn, the FAA Private Pilot Certificate may be granted college credit consistent with the Credit by Examination requirements published in the catalog. Pass/No Pass/Letter Grade Option (CSU)

ATC 191 C Airline Reservations: APOLLO 3 Units

Term hours: 36 lecture and 54 laboratory. This course is an introduction to APOLLO, the computer reservations system used by United Airlines and one of the two major systems used by travel consultants. Students will learn how to build PNR's (passenger name records), quote fares, and calculate prices through hands-on applications on computers. \$4.00 Material Fee-Payable at Registration. (Credit by Examination) (CSU)

ATC 192 C Airline Reservations: SABRE 3 Units

Term hours: 36 lecture and 54 laboratory. This course is an introduction to SABRE, the computer reservations system used by American Airlines and one of the two major systems used by travel consultants. Students will learn how to build PNR's (passenger name records), quote fares, and calculate prices through hands-on applications on computers. \$4.00 Material Fee-Payable at Registration. (CSU)

ATC 193 C Flight Training-Flight Instructor 1 to 5 Units

Prerequisite: Students must provide substantiation of an FAA Flight Instructor Rating, or concurrent enrollment in an approved flight training program working toward an FAA Flight Instructor Rating, and completion of or concurrent enrollment in at least 3 units of ATC (132 or above) with a "C" or higher grade.

Term hours: hours as required by FAA. Students who have earned, or are enrolled in an approved flight school and will earn, an FAA Instructor Rating, may be granted college credit as follows: One unit of credit may be granted for each of the following Flight Instructor Certificates or Ratings: Airplane Single Engine, Airplane Multi-engine, Rotorcraft, Glider and Instrument. Credit may be granted by meeting the above prerequisites and the Credit by Examination procedures as published in this catalog. Credit may be given up to 4 times for a maximum of 5 units. Pass/No Pass/Letter Grade Option. (CSU)

ATC 194 C Flight Training Instrument Rating 2 Units

Prerequisite: Students must provide substantiation of an FAA Instrument Rating, or concurrent enrollment in an approved flight training program working toward an FAA Instrument Rating, and completion of or concurrent enrollment in at least 3 units of ATC (132 or above) with a "C" or higher grade.

Term hours: Hours as required by FAA. Students who have earned, or are enrolled in an approved flight school and will earn, an FAA Instrument Rating on their Pilot Certificate may be granted college credit by meeting the above prerequisites and the Credit by Examination requirements as published in the current Cypress Catalog. Pass/No Pass/Letter Grade Option. (CSU) FAA Pilot Certificate with Instrument Rating and completion of at least 3 units of ATC (132 or above) with a "C" or higher grade.

ATC 195 C Flight Training Commercial Pilot 2 Units

Prerequisite: Students must provide substantiation of an FAA Commercial Pilot Certificate, or concurrent enrollment in an approved flight training program working toward an FAA Commercial Pilot Certificate, and completion of or concurrent enrollment in at least 3 units of ATC (132 or above) with a "C" or higher grade.

Term hours: hours as required by FAA. Students who have earned, or are enrolled in an approved flight school and will earn, an FAA Commercial Pilot Certificate may be granted college credit by meeting the above prerequisites and the Credit by Examination requirements as published in the current Cypress Catalog. Pass/No Pass/Letter Grade Option. (CSU)

ATC 196 C Flight Simulator Private Pilot 1 Unit

Formerly AVIA 196 C

Advisory: Completion of or concurrent enrollment in ATC 132 C or completion of FAA Private Pilot Certificate, or taking flight lessons at a local flight school.

Term Hours: 18 lecture and 18 laboratory. Students will participate in hands-on flight simulation activities to develop, practice, and optimize essential private pilot flight skills. Flight time in the approved ground trainers may be applied toward requirements for both attaining and maintaining flight ratings. (CSU)

- ATC 197 C Flight Simulator Instrument** **1 Unit**
Formerly AVIA 197 C
Advisory: Concurrent enrollment in or completion of ATC 132 C, or completion of FAA Private Pilot Certificate, or taking flight lessons at a local flight school.
Term hours: 18 lecture and 18 laboratory. Students will participate in hands-on flight simulation activities to develop, practice, and optimize essential instrument related flight skills. Flight time in the approved ground trainers may be applied toward requirements for both attaining and maintaining flight ratings. Pass/No Pass/Letter Grade Option. (CSU)
- ATC 198 C Flight Simulator Commercial** **1 Unit**
Advisory: Completion of or concurrent enrollment in ATC 132 C or completion of FAA Private Pilot Certificate and ATC 196 C and ATC 197 C.
Term hours: 18 lecture and 18 laboratory. Students will participate in hands-on flight simulation activities to develop, practice, and optimize essential commercial flight skills. Flight time in the approved ground trainers may be applied toward requirements for both attaining and maintaining flight ratings. Pass/No Pass/Letter Grade Option. (CSU)
- ATC 199 C Flight Simulator Instructor** **1 Unit**
Advisory: Completion of or concurrent enrollment in ATC 132 C or completion of FAA Private Pilot Certificate and ATC 196 C, ATC 197 C, and 198 C or the equivalent.
Term hours: 18 lecture and 18 laboratory. Students will participate in hands-on flight simulation activities to develop, practice, and optimize essential instructor flight skills. Flight time in the approved ground trainers may be applied toward requirements for both attaining and maintaining flight ratings. Pass/No Pass/Letter Grade Option. (CSU)
- ATC 210 C Cabin Safety Simulation** **.5 Units**
Advisory: Completion of or concurrent enrollment in ATC 270 C or ATC 274 C.
Term hours: 9 lecture. Students will participate in an aircraft emergency evacuation in a cabin simulator at the Long Beach Airport. A required 6-hour preparatory class will be held on campus and the remaining 3 hours will be delivered at the airport. Students will be provided a certificate upon successful completion. Facility Use Fee of \$100 required. Payable at Registration. Fee subject to change by facility. (CSU)
- ATC 212 C Airline/Aviation Management** **3 Units**
Formerly AVIA 112 C
Term Hours: 54 lecture. Students will study the application of management principles to the airlines and general aviation. Major areas of study include planning, organization, regulations, manpower management, facilities, marketing, administration, safety, security, and supervision strategies. (CSU)
- ATC 220 C Advanced Air Navigation** **2 Units**
Formerly AVIA 220 C
Prerequisite: Completion of or concurrent enrollment in ATC 136 C.
Term Hours: 36 lecture. This is a course stressing advanced navigation methods and principles including radio and electronic navigation aids, glass cockpit, and flight management systems. (CSU)
- ATC 223 C Cruise Line Sales and Operations** **3 Units**
Term hours: 54 lecture. This course provides students with a practical, working knowledge of the cruise industry, including its operation, terminology, associations, and resources. Students will learn how to differentiate, price, market, and sell cruises. Pass/No Pass/Letter Grade Option. (CSU)

- ATC 232 C Instrument Rating** **3 Units**
Formerly AVIA 232 C
Prerequisite: Completion of or concurrent enrollment in ATC 132 C with a minimum grade of "C".
Term Hours: 54 lecture. This course is designed to prepare or requalify the student in instrument flight procedures and techniques, including air traffic control, publications and regulations. This course reviews aeronautical ground training required to pass the FAA Instrument Pilot, Instrument Flight Instructor and Instrument Ground Instructor Knowledge Examinations. Flight time in a Flight Training Device is available by concurrent enrollment in ATC 196 C. Credit by Examination procedures as published in this catalog. (CSU)
- ATC 236 C Aerodynamics** **3 Units**
Formerly AVIA 236 C
Advisory: Concurrent enrollment in, or completion of, ATC 132 C or completion of FAA Private Pilot Certificate.
Term Hours: 54 lecture. Students will learn the basic principles of aerodynamics, including airfoil shapes and characteristics, viscous effects, propellers, and aircraft performance viewed in terms of the basic laws of physics, aircraft limitations and Federal Aviation Regulations. Emphasis will be on physical aspects of flight time. (CSU)
- ATC 240 C Commercial Pilot Seminar** **3 Units**
Formerly AVIA 240 C
Prerequisite: ATC 136 C, ATC 140 C, Pilot Certificate.
Term Hours: 54 lecture. This course is a review of current Federal Aviation Regulations and Government Publications for the active pilot, aircraft loading and weight and balance; review of the aeronautical knowledge required to pass the FAA Commercial Pilot knowledge examination. This course meets partial fulfillment of the FAA requirements for ground training, ATC 240 C may count toward the Aviation Major requirements the first time only. (Flight Training Device flight time is available by concurrent enrollment in ATC 196 C or ATC 197 C.) Pass/No Pass/Letter Grade Option. (CSU)
- ATC 244 C Aviation Instructor** **3 Units**
Formerly AVIA 244 C
Prerequisite: ATC 240 C and 120 hours of flight time.
Term Hours: 18 lecture and 98 laboratory. This course is a study of principles of learning and teaching, elements of practical educational psychology, and a review of current trends and techniques in aviation instruction. Class participation in lesson preparation is included. This course meets partial fulfillment of the requirements of the FAA for ground instruction in preparation for the FAA Fundamentals of Instruction, Ground Instructor and Flight Instructor knowledge exams. (CSU)
- ATC 250 C Turbine Simulator Observation** **.5 Units**
Formerly AVIA 250 C
Corequisite: Must be enrolled in another ATC course.
Term Hours: 9 lecture. Students will be introduced to a full-motion turbine aircraft flight deck, including familiarization with the fundamentals of flight, flight deck controls, instrument interpretation, and aircraft systems. A required 3-hour preparatory class will be held on campus, and the remaining 6 hours will be delivered at FlightSafety International. Students will need to supply a picture ID and an approved background check before entrance to FlightSafety International. Fee may be required, subject to change by facility. (CSU)

ATC 255 C Turbine Simulator Orientation .5 Units

Formerly AVIA 255 C

Advisory: Completion of, or concurrent enrollment in, ATC 250 C Jet Simulator Observation.

Term Hours: 9 lecture. Students will practice the fundamentals of flight, utilizing the flight deck's controls, instruments, and basic systems in a full-motion turbine flight simulator. A required 3-hour preparatory class will be held on campus, and the remaining 6 hours will be delivered at FlightSafety International. Students will need to supply a picture ID and an approved background check before entrance to FlightSafety International. Fee may be required, subject to change by facility. (CSU)

ATC 256 C Crew Resource Management 3 Units

Term hours: 54 lecture. This course will examine the concepts of Crew Resource Management (CRM) and Human Factors and Aeronautical Decision Making currently practiced in commercial and corporate aviation. The role of crew supervision and training, leadership styles and management oversight will be studied. Single and multi-crew aircraft situations will be studied. Human factors research and aircraft accident investigations will be examined. (CSU)

ATC 260 C UAV/UAS Advanced 3 Units*Advisory: Recommend completion of, or concurrent enrollment in, ATC 160 C, ATC 161 C, and ATC 162 C or the equivalent.*

Term hours: 54 lecture. Examines the core technologies of unmanned aircraft systems (UAS), including the design concepts, power plants, control systems, and communication technologies. Explores cross-country navigation, flight planning, payload, sensors, and autonomous operations. Emphasizes the ethical, legal, and safety related requirements of operation in the public, civil, commercial and military settings. (CSU)

ATC 261 C UAV/UAS Advanced Simulator 1 Unit*Advisory: Concurrent enrollment in or completion of ATC 260 C, UAV/UAS Basic.*

Term hours: 18 lecture and 18 laboratory. Advanced UAV/UAS simulator course, providing hands-on flight simulation activities to improve, practice, and optimize essential Unmanned Aircraft Systems pilot flight skills. Flight time in the approved ground trainers may be applied toward requirements for both attaining and maintaining flight ratings. (CSU)

ATC 262 C UAV/UAS Advanced Flight 2 Units*Advisory: Concurrent enrollment in or completion of ATC 260 C and ATC 261 C.*

Term hours: 18 lecture and 54 laboratory. Advanced UAV/UAS flight activities to practice and optimize essential Unmanned Aircraft Systems skills. Flight time in the approved UAV/UAS aircraft may be applied toward requirements for both attaining and maintaining flight ratings. (CSU)

ATC 270 C Airline Operations 3 Units

Term hours: 54 lecture. This course is designed for students interested in working in the airline industry. Students will learn airline terminology, city codes, the 24-hour clock, airline operations, and industry hiring standards. (CSU)

ATC 271 C Airport Operations 3 Units

Term hours: 54 lecture. This course provides students with a background in general aviation and commercial airports. Students will learn about airport operations, including terminology, ground and baggage handling, terminal and airfield operations, hazardous material, aircraft emergencies, ground access, and FAR Part 139. (CSU)

ATC 274 C Passenger Services and Safety 3 Units

Term hours: 54 lecture. Students will learn about passenger related service and safety procedures for the airline industry, including first aid, CPR, fire-fighting, and conflict resolution. (CSU)

ATC 278 C Public Relations 3 Units

Term hours: 54 lecture. This course introduces students to the public relations concepts and practices in the airline and travel industries. Students will examine promotional campaigns and develop their own public relations proposal with emphasis on practical applications. (CSU)

ATC 295 C Aviation/Travel Internship 3 Units*Prerequisite: Completion of the Basic Airline Customer Services Certificate; or Basic Flight Attendant Certificate; or Basic Travel/Tourism Certificate.*

Term hours: 18 lecture and 270 laboratory. This course offers practical work experience in an approved aviation and travel related industry for the student(s) in the Aviation and Travel Careers program. This course is designed to provide vocational learning opportunities through employment. (CSU)

ATC 298 C Aviation/Travel Seminar .5 to 12 Units*Prerequisite: May be required.**Corequisite: May be required.**Advisory: May be required.*

Term hours: 9-216 lecture and/or 9-1620 laboratory depending on units attempted. This course is for students who wish to increase their knowledge of the aviation and travel industry. Various topics will be offered. Unit credit may range from 1/2 to 12 units in any given semester. Consult the class schedule to verify credit for a particular semester. May be taken for credit 1-4 times. Pass/No Pass or Pass/No Pass/Letter Grade Option or Standard Letter Grade. Fees may be required-Payable at Registration. (CSU)

ATC 299 C Independent Study .5 to 2 Units*Prerequisite: Approved Independent Study Learning Contract.*

Term hours: 8-36 lecture. This course is designed for those students who wish to increase their knowledge of the airline and/or travel industry through professionally directed independent study or research. Unit credit may range from 1/2 to two units in any given semester. May be taken for credit 4 times. (CSU)

Biology

Division of Science/Engineering/Mathematics

Division Dean — Richard Fee*Faculty*

Sujata Chiplunkar

David Gill

Joel Gober

Alex Mintzer

Fumio Ogoshi

Michelle Palmisano

Adel Rajab

Tony Sanchez

Dee Ann Sato

Gary Shin

Stephanie Spooner

Counselor

Deidre Porter

PROGRAM LEARNING OUTCOMES (PLOs)

The courses taught by this department contribute to the General Education and Basic Skills Program Learning Outcomes. Please refer to General Education and Basic Skills Program Learning Outcomes.

Cypress College Biology AS-T Majors Course Sequence*

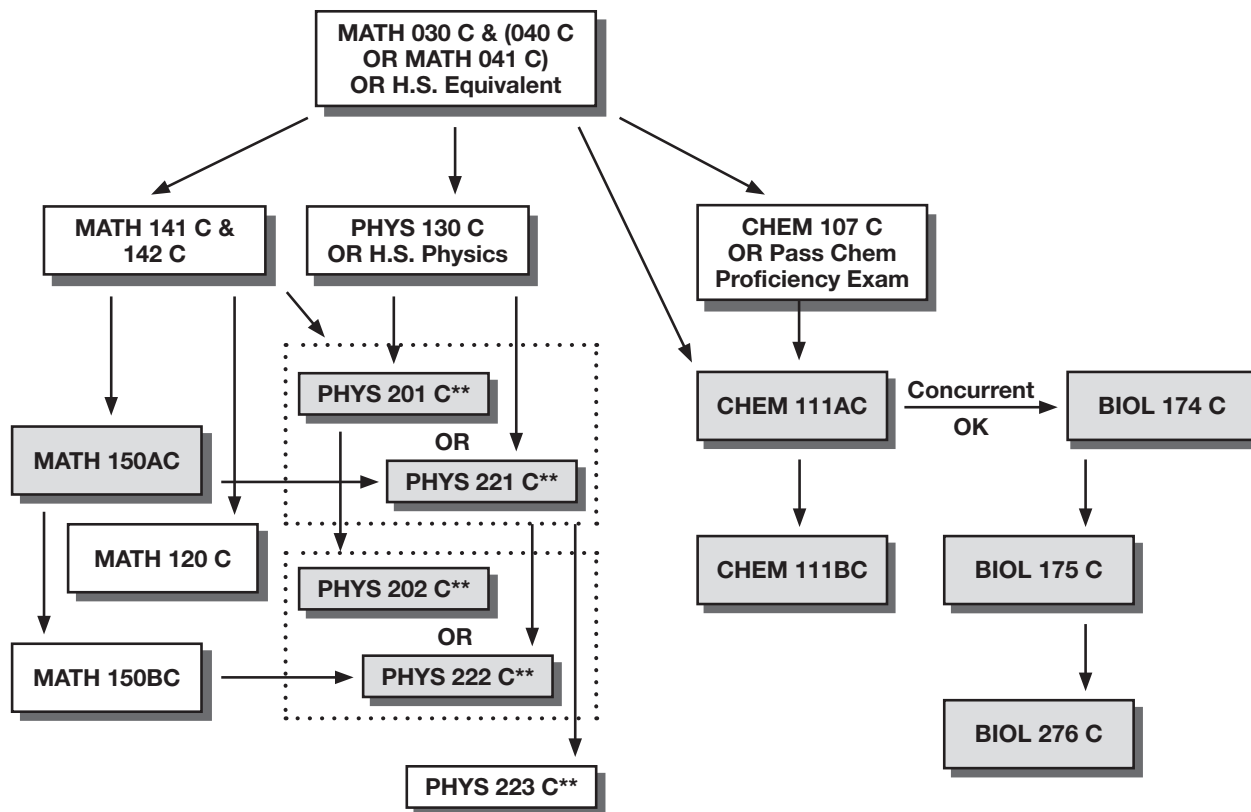

*Each UC and CSU university has specific transfer requirements. Please consult with your counselor and www.assist.org for campus-specific requirements.

**Biology AS-T degree seekers may also consider PHYS 210 C and 211 C (Physics for Life Sciences I and II) but should consult with their counselor first.

Shaded boxes are core courses or require supporting science and mathematics courses within the Biology Transfer AS degree (AS-T). Other courses may be transferable to individual CSU or UC universities.

Contact: Adel Rajab at arajab@CypressCollege.edu or (714) 484-7000 x48629

BIOLOGICAL SCIENCES TRANSFER PROGRAM

Students should consult a counselor or www.assist.org for lower division major requirements for most California public universities. (See the Standard Definitions section of the catalog for a description of ASSIST.) Students transferring to an independent college/university should consult the catalog of the individual school and a counselor for lower division major requirements.

Biology (BIOL)

BIOL N01 C Supervised Tutoring-Science and Engineering

4-48 Hours

Term hours: 4-48 laboratory. This course provides individual tutoring based on each student's needs in science and engineering courses. Students wishing to use the Science Learning Center must enroll in this course. Non-Credit course. Open Entry/Open Exit. Pass/No Pass.

BIOL 101 C General Biology

5 Units

Advisory: High school chemistry or CHEM 101 C or CHEM 107 C are recommended.

Term hours: 72 lecture and 54 laboratory. The course is a survey of modern biological concepts from the areas of molecular, cellular, organismic, and population biology, stressing evolution as the central theme of modern biology. The study of the flow of energy through biological systems is emphasized. This is a general education course in the biological science area. This course will satisfy the Biological Sciences portion of the state college and university general education requirement. Duplicate credit not granted for BIOL 101HC. No Credit if taken after BIOL 174 C, BIOL 176 C or BIOL 177 C. Pass/No Pass/Letter Grade Option. (UC Credit Limitation/CSU, AA GE, CSU GE, IGETC)

BIOL 101HC Honors General Biology 5 Units

Advisory: High school chemistry or CHEM 101 C or CHEM 107 C are recommended.

Term hours: 72 lecture and 54 laboratory. The course is an enhanced survey of modern biological concepts for Honors students. The emphasis of this course is on contemporary readings of relevant biology literature. Written essays pertaining to current issues in biology will be paramount. The class will be conducted as a seminar and will require a significant research project that uses correct documentation skills. The course will develop increased critical thinking, reading and writing skills. BIOL 101HC will satisfy the Geological Sciences portion of the state college and university general education requirement. Duplicate credit not granted for BIOL 101 C. No Credit if taken after BIOL 174 C, BIOL 176 C or BIOL 177 C. (UC Credit Limitation/CSU, AA GE, CSU GE, IGETC)

BIOL 102 C Human Biology 3 Units

Term hours: 54 lecture. The course is a study of modern biological concepts presented in a human context. The concepts will include human evolution, anatomy, physiology, genetics, population biology, and ecological principles. Included in the course will be discussion on current topics on environmental and public health issues as they relate to the human condition. Not open to students with credit in BIOL 101 C or BIOL 101HC. Pass/No Pass/Letter Grade Option. (UC/CSU, AA GE, CSU GE, IGETC)

BIOL 103 C Environmental Science 3 Units

Term hours: 54 lecture. The course is a study of the ecological principles which form the basis for understanding human existence in relation to environment quality. The topics include human, biological, and cultural evolution; ecological principles; human population issues; and problems relating to the development and use of energy and other resources. In addition, the causes and consequences of pollution will be addressed. The development of an earth ethic will be emphasized. Pass/No Pass/Letter Grade Option. (UC/CSU, AA GE, CSU GE, IGETC)

BIOL 107 C Nutrition and World Food Issues 3 Units

Term hours: 54 lecture. This course is a study of the biological basis of human nutrition, including a survey of anatomical and physiological principles. A study of the human diet in the context of disease prevention, world food supply, and ecological factors will also be included. Pass/No Pass/Letter Grade Option. (UC/CSU, AA GE)

BIOL 122 C Marine Biology 4 Units

Term hours: 54 lecture and 54 laboratory. This is a survey of the natural history and biology of marine organisms, and includes an introduction to physical and chemical oceanography, marine ecology, and energy flow within the marine environment, as well as some basic biological concepts using live ecosystems as examples. Pollution and conservation of the marine environment will also be considered. The course satisfies the biological science with a laboratory transfer requirement of universities and state colleges. A single optional boat field trip may be scheduled with a charter cost not to exceed \$30.00. Other optional no-cost field trips will be scheduled. Pass/No Pass/Letter Grade Option. (UC/CSU, AA GE, CSU GE, IGETC)

BIOL 125 C Island Biology 2 Units

Advisory: BIOL 122 C.

Term hours: 27 lecture and 36 laboratory. This course is designed as an introduction to the nature and diversity of island life. It offers the student an opportunity to study marine communities with an emphasis on community interactions. The course will also include a consideration of marine wilderness and conservation problems as well as biological processes as they occur on islands. One or more weekend field trips for snorkeling, free diving and field study will be an integral part of the course. A boat charter fee not to exceed \$50 may be required for field trips to the islands. Pass/No Pass/Letter Grade Option. (CSU)

BIOL 160 C Integrated Medical Science 3 Units

Term hours: 54 lecture. This is a one-semester course that includes a systematic coverage of fundamental physical/chemical principles, basic biological concepts, and fundamentals of anatomy and physiology. The course is designed for various allied health programs (psychiatric technician, court reporting, etc.) or others who desire a background in human biology. Pass/No Pass/Letter Grade Option. (CSU, AA GE)

BIOL 174 C Biology of Cells and Tissues 4 Units

Prerequisite: Completion of or concurrent enrollment in CHEM 111AC with a minimum grade of "C".

Advisory: ENGL 060 C.

Term hours: 54 lecture and 54 laboratory. This is the first course within the biology majors AS degree. This course presents the biochemistry and molecular biology of cells and tissues. Representative topics to be included are: biomolecules, cell structure and metabolism, cell growth and reproduction, cell integration into tissues, and basic Mendelian and molecular genetics. This course will meet the preparation needs of students transferring to upper division biology study. Duplicate credit not granted for BIOL 111 C and BIOL 112 C. Cost of field trips not to exceed \$30.00. (UC Credit Limitation/CSU, AA GE, CSU GE, IGETC, C-ID: BIOL 190)

BIOL 175 C Evolution and Biodiversity 4 Units

Prerequisite: BIOL 174 C with a minimum grade of "C" or completion of BIOL 111 C or equivalent course with a grade of "C" or better.

Term hours: 54 lecture and 54 laboratory. This is the second course within the biology majors AS degree. This course is designed to introduce students to the concept of evolution as the mechanism responsible for diversity at all levels of biological organization. A focus of the course will be the scientific method of investigation. This course is designed for science majors in transfer programs to upper-division study of biology. Duplicate credit not granted for BIOL 113 C and BIOL 114 C. Cost of field trips not to exceed \$30.00. (UC Credit Limitation/CSU, AA GE, CSU GE, IGETC, C-ID: BIOL 140)

BIOL 210 C Anatomy and Physiology 5 Units

Advisory: BIOL 160 C, or one semester each of college biology/chemistry, or one year each of high school biology/chemistry completed within the last five years.

Term hours: 54 lecture and 108 laboratory. The course includes a study of the normal structure and function of the human body using mammalian specimens as examples. Selected physiological exercises are included which often utilize the student's own body function. This course is designed for students pursuing the health professions (radiological technology, medical records technology, respiratory therapy, etc.), physical education majors, and any other interested students. (Not open to students with credit in BIOL 240 C.) Pass/No Pass/Letter Grade Option. (UC/CSU, AA GE, CSU GE, IGETC)

BIOL 220 C Medical Microbiology 4 Units

Prerequisite: BIOL 231 C or BIOL 210 C with minimum grades of "C".

Term hours: 54 lecture and 54 laboratory. This course is a study of the etiology, transmission, pathology, diagnosis and control of infectious disease. Special attention is given to the topics of immunology and chemotherapy. Laboratory emphasis is placed on providing experience and insight into the processes of specimen handling, isolation, identification, and sensitivity testing of pathogenic microorganisms. Aseptic techniques are stressed throughout the course. This course is recommended for students of nursing (RN), dental technology, medical records, and baccalaureate degree medical or public health programs. Recommended background is one year each, high school chemistry/biology, or one semester each, college chemistry/biology. If the student has no science background, prior completion of BIOL 160 C is strongly recommended. Pass/No Pass/Letter Grade Option. (CSU)

BIOL 231 C General Human Anatomy 4 Units

Prerequisite: Minimum grades of "C" in MATH 040 C or MATH 041 C and ENGL 060 C.

Advisory: High School Biology and Chemistry with minimum grades of "C" or BIOL 101 C or BIOL 160 C.

Term hours: 54 lecture and 54 laboratory. This course presents a logical analysis of body tissues, organs, and systems. It stresses the microscopic, developmental, and gross anatomy of mammals, with special emphasis on human anatomy. Special attention is given to pathological as well as normal conditions. The three hour laboratory includes dissection and study of fresh and preserved specimens and models. This course is designed primarily for physical education and allied health majors. High school biology and chemistry, or equivalent is recommended background. Students are encouraged to take BIOL 101 C and BIOL 160 C if they have no previous science background. Pass/No Pass/Letter Grade Option. (UC/CSU, AA GE, CSU GE, IGETC, C-ID: BIOL 110B)

BIOL 241 C General Human Physiology 4 Units

Prerequisite: BIOL 210 C or BIOL 231 C with grades of "C".

Advisory: CHEM 101 C.

Term hours: 54 lecture and 54 laboratory. This course is an in-depth study of human function. Special attention is given to the abnormal as well as the normal functional state. The laboratory experience includes selected exercises that emphasize the interrelationships between structure and function. It is designed primarily for physical education and allied health programs that require 3 hours of laboratory per week. Pass/No Pass/Letter Grade Option. (UC/CSU, CSU GE, AA GE, IGETC, C-ID: BIOL 120B)

BIOL 276 C Ecology and Physiology 4 Units

Prerequisite: BIOL 175 C with a minimum grade of "C".

Term hours: 54 lecture and 54 laboratory. This is the third course within the Biology majors AS degree. This course examines the basic principles governing interactions between organisms and the environment and the physiological responses of organisms to external and internal stimuli. Intended for biology majors, this lecture/lab course emphasizes ecological principles and relationships among organisms and between organisms and their environments. The course also emphasizes the physiology of plant and animal systems. Cost of field trips not to exceed \$30.00. (UC/CSU, AA GE, CSU GE, IGETC)

BIOL 277 C Genetics 3 Units

Formerly BIOL 177 C

Prerequisite: BIOL 174 C.

Term hours: 54 lecture. This course presents an introduction to genetics, inheritance and genetic changes that occur over time in individuals and populations. Basic features of the replication and expression of DNA, cell division and gene transmission are considered. Recombination and mutation in diploid organisms are discussed. Concepts of genetic variability and the role of natural selection in the evolution of populations are presented. Cost of field trips not to exceed \$30.00. (UC/CSU, AA GE, CSU GE, IGETC)

BIOL 278 C Molecular Biology 4 Units

Prerequisite: BIOL 277 C and CHEM 211AC with minimum grades of "C".

Term hours: 72 lecture. This course presents the structure and function of proteins and nucleic acids, mechanisms of gene expression and regulation, biotechnology and molecular methods of experimentation, and genomics analysis. In addition, this course presents the molecular mechanisms of cell signaling pathways as well as errors in these pathways leading to cancer and other disorders. The importance of viral life cycles in understanding basic molecular and cellular processes will be included. Finally, the major biochemical pathways in cells, with an emphasis on the thermodynamic constraints on living systems, will also be studied. (UC/CSU, AA GE, CSU GE, IGETC)

BIOL 298 C Biology Seminar .5 to 12 Units

Prerequisite: May be required.

Corequisite: May be required.

Advisory: May be required.

Term hours: 0-12 lecture and/or 0-36 laboratory depending on units attempted. This seminar is designed to intensify knowledge in a variety of biological topics. They may include lectures, discussions, field excursions, and other activities at the discretion of the instructor. Actual seminar topics will be listed in the class schedule for a particular semester. Pass/No Pass or Pass/No Pass/Letter Grade Option or Standard Letter Grade. Fees may be required-Payable at Registration. (UC Credit Limitation/CSU)

BIOL 299 C Independent Study for Biology .5 to 2 Units

Prerequisite: Approved Independent Study Learning Contract.

Term hours: 0-36 lecture and 0-108 laboratory depending on units attempted. This is for biology majors who have demonstrated interest in and capability for increased knowledge of biological and medical sciences through individual study, small group discussion/conference, special laboratory projects, or field research projects. May be taken for Credit 4 times. Pass/No Pass/Letter Grade Option. (UC Credit Limitation/CSU)

Business — See Accounting (ACCT), or Management (MGT), or Marketing (MKT)

Business Administration

ASSOCIATE IN SCIENCE IN BUSINESS ADMINISTRATION FOR TRANSFER DEGREE (AS-T) Program Code: 1S31295

This curriculum is designed to provide an opportunity for the Business Administration major to achieve an Associate in Science in Business Administration for Transfer Degree (AS-T in Business Administration) which completes the first and second year requirements for transfer into the CSU system.

Advanced degrees and/or professional certificates, such as a baccalaureate degree, are required for those considering professional careers. Completion of this curriculum will demonstrate a commitment to the field and provide comprehensive preparation for further academic study through upper-division course work. This curriculum specifically prepares the prospective transfer student for upper division course work in Business Administration or a similar major at a California State University (CSU) campus. Students should consult a counselor, the Transfer Center and the catalog of the transfer college or university to plan a specific program of study to meet the college or university's requirements. Note: Courses that fulfill major requirements for an Associate Degree for Transfer at Cypress College might not be the same as those required for completing the major at all transfer institutions offering a Baccalaureate Degree.

The Student Transfer Achievement Reform Act (Senate Bill 1440, now codified in California Education Code sections 66746–66749) guarantees admission to a California State University (CSU) campus for any community college student who completes an “associate degree for transfer,” a newly established variation of the associate degrees traditionally offered at a California community college. The AS-T is intended for students who plan to complete a bachelor’s degree in a similar major at a CSU campus. Students completing these degrees (AS-T) are guaranteed admission to the CSU system, but not to a particular campus or major. Students transferring to a CSU campus that does accept the AS-T will be required to complete no more than 60 units after transfer to earn a bachelor’s degree (unless the major is designated “high-unit” major). This degree may not be the best option for students intending to transfer to a particular CSU campus or to a university or college that is not part of the CSU system. Students should consult with a counselor when planning to complete the degree for more information on university admission and transfer requirements.

Students successfully completing the AS-T in Business Administration will gain knowledge in accounting, business communications, information technologies, finance, law, management, and marketing. Because business is such a broad field with many emphases and majors, this degree will provide the student a broad overview of the possible fields of study in various business areas.

To earn an AS-T in Business Administration students must complete the following requirements: (1) a minimum of 27–29 semester units or 40.5–43.5 quarter units in the Business Administration major with a minimum grade of “C”; (2) California State University General Education Breadth requirements (CSU GE Breadth) or the Intersegmental General Education Transfer Curriculum (CSU IGETC); (3) elective courses to complete a minimum of 60 units of CSU transferable course work; (4) have an overall GPA of 2.0.

Required Core Courses are listed in suggested sequence.

| | | Units |
|------------|---------------------------------|-------|
| ACCT 101 C | Financial Accounting | 4 |
| ACCT 102 C | Managerial Accounting | 4 |
| ECON 100 C | Principles of Economics — Macro | 3 |
| | or | |
| ECON 100HC | Honors Principles of Economics | (3) |
| ECON 105 C | Principles of Economics — Micro | 3 |
| | or | |
| ECON 105HC | Honors Principles of Economics | (3) |
| MGT 240 C | Legal Environment of Business | 3 |

List A: Select one of the following: (4 units)

| | | Units |
|------------|--|-------|
| MATH 130 C | Survey of Calculus | 4 |
| MATH 120 C | Introduction to Probability and Statistics | 4 |
| MATH 115 C | Finite Mathematics | 4 |

List B: Select two of the following or any courses from List A not already chosen. (6–8 units)

| | | Units |
|-----------|------------------------------|-------|
| CIS 111 C | Computer Information Systems | 3 |
| MGT 161 C | Introduction to Business | 3 |
| | or | |
| MGT 211 C | Writing for Business | (3) |

Total Units Required 27–29

BUSINESS ADMINISTRATION TRANSFER PROGRAM

Accounting, Finance, International Business, Marketing, Management, Management — Information Systems, Quantitative Systems

Students should consult a counselor or www.assist.org for lower division major requirements for most California public universities. (See the Standard Definitions section of the catalog for a description of ASSIST.) Students transferring to an independent college/university should consult the catalog of the individual school and a counselor for lower division major requirements.

GENERAL BUSINESS TRANSFER PROGRAM

Accounting, Information Technologies, Finance, Law, Management, and Marketing

Students should consult a counselor or www.assist.org for lower division major requirements for most California public universities. (See the Standard Definitions section of the catalog for a description of ASSIST.) Students transferring to an independent college/university should consult the catalog of the individual school and a counselor for lower division major requirements.

Business Law — See Management (MGT)

Chemistry

Division of Science/Engineering/Mathematics

Division Dean — Richard Fee

Faculty

Robin De Roo
Torri Draganov
Allison Gotoh
Lenore Landis
Sheila Nguyen
Craig Tomooka

Counselor

Deidre Porter

PROGRAM LEARNING OUTCOMES (PLOs)

The courses taught by this department contribute to the General Education and Basic Skills Program Learning Outcomes. Please refer to General Education and Basic Skills Program Learning Outcomes.

CHEMISTRY TRANSFER PROGRAM

Students should consult a counselor or www.assist.org for lower division major requirements for most California public universities. (See the Standard Definitions section of the catalog for a description of ASSIST.) Students transferring to an independent college/university should consult the catalog of the individual school and a counselor for lower division major requirements.

ASSOCIATE IN SCIENCE DEGREE IN CHEMISTRY FOR TRANSFER DEGREE (AS-T)

Program Code: 1S33954

This curriculum is designed to provide an opportunity for the Chemistry major to achieve an Associate in Science in Chemistry for Transfer (AS-T in Chemistry) which completes the first and second year requirements for transfer to a four-year public California institution. Students with a degree in chemistry may pursue careers in a variety of fields such as pharmacy, medicine, engineering, teaching, biotechnology, patent law, and forensic science. While at least a baccalaureate degree is recommended preparation for those considering professional careers, completion of this curriculum will demonstrate commitment to the field and provide comprehensive preparation for further academic study through upper-division course work. This curriculum specifically prepares the prospective transfer student for upper division coursework in Chemistry or a similar major at a California State University (CSU) campus. Students should consult a counselor, the Transfer Center, and the catalog of the transfer college or university to plan a specific program of study to meet the college or university's requirements.

Note: Courses that fulfill major requirements for an Associate Degree for Transfer at Cypress College might not be the same as those required for completing the major at all transfer institutions offering a Baccalaureate Degree. The Student Transfer Achievement Reform Act (Senate Bill 1440, now codified in California Education Code sections 66746–66749) guarantees admission to a California State University (CSU) campus for any community college student who completes an “associate degree for transfer”, a newly established variation of the associate degrees traditionally offered at a California community college. The AS-T is intended for students who plan to complete a bachelor's degree in a similar major at a CSU campus. Students completing these degrees (AS-T) are guaranteed admission to the CSU system, but not to a particular campus or major. Students transferring to a CSU campus that does accept the AS-T will be required to complete no more than 60 units after transfer to earn a bachelor's degree (unless the major is designated “high-unit” major). This degree may not be the best option for students intending to transfer to a particular CSU campus or to a university or college that is not part of the CSU system. The completion of this curriculum will demonstrate commitment to the Chemistry field and provide comprehensive preparation for upper-division work.

To earn an AS-T in Chemistry, students must complete the following requirements: (1) a minimum of 36 semester units or 54 quarter units in the Chemistry major with a minimum grade of “C” in each course; (2) the Intersegmental General Education Transfer Curriculum (CSU IGEC) for STEM*; (3) completion of 60 semester or 90 quarter units of CSU transferable coursework; and (4) have an overall GPA of 2.0 or higher.

*Note: The California State University General Education Breadth pattern (CSU GE) is NOT an option for this degree. Students must use the Intersegmental General Education Transfer Curriculum (CSU IGEC) for STEM which allows students to take one Arts or Humanities course and one Social or Behavioral Science course after transfer. Students should consult with a counselor when planning to complete the degree for more information on specific university admission and transfer requirements.

| Required Courses: (36 units) | | Units |
|------------------------------|----------------------|-----------|
| CHEM 111AC | General Chemistry I | 5 |
| CHEM 111BC | General Chemistry II | 5 |
| CHEM 211AC | Organic Chemistry I | 5 |
| CHEM 211BC | Organic Chemistry II | 5 |
| PHYS 221 C | General Physics I | 4 |
| PHYS 222 C | General Physics II | 4 |
| MATH 150AC | Calculus I | 4 |
| MATH 150BC | Calculus II | 4 |
| Total Units Required | | 36 |

Chemistry (CHEM)

CHEM 060 C Chemistry Review 1 Unit

Term hours: 18 lecture. This course is a review of the concepts and principles of general, inorganic, and organic chemistry, as taught in: Introduction to Chemistry (CHEM 101 C), Fundamentals of College Chemistry (CHEM 107 C), General Chemistry I (CHEM 111AC) and/or General Chemistry II (CHEM 111BC). It is recommended for students who have completed or are currently enrolled in one of the previously named courses. Non-Degree Credit. Pass/No Pass only.

CHEM 100 C Chemistry for Daily Life 4 Units

Term hours: 54 lecture and 54 laboratory. The course is designed for the non-science major seeking a laboratory science. The course will adopt a non-mathematical approach to explain the fundamental concepts of chemistry. From this foundation, the course will focus on topics that are related to the impact that chemistry has on our society. The laboratory section will provide hands-on experience with many of the lecture topics. Pass/No Pass/Letter Grade Option. (UC Credit Limitation/CSU, AA GE, CSU GE, IGEC)

CHEM 101 C Chemistry for Health Science Majors I 4 Units

Prerequisite: MATH 020 C or MATH 041 C with minimum grades of “C”.
Term hours: 54 lecture and 54 laboratory. This course is the first semester of a two-semester sequence (CHEM 101 C and CHEM 201 C). This course covers the basic principles of atomic structure, chemical bonding, the mole concept, states of matter, solutions, energy, and organic compounds. This course is designed for students majoring in health science. (UC Credit Limitation/CSU, AA GE, CSU GE, IGEC, C-ID CHEM 101)

CHEM 103 C Chemistry and Society 3 Units

Prerequisite: Completion of or concurrent enrollment in MATH 020 C or MATH 041 C with minimum grades of “C”.
Term hours: 54 lecture. This is a general education course in chemistry. This course introduces students to basic concepts of chemistry and requires analyses of the socio-cultural contexts within which chemistry plays a central role. The course is designed to provide a general educational exposure to the physical sciences, specifically chemistry, and is not recommended for science majors. Pass/No Pass/Letter Grade Option. (UC Credit Limitation/CSU, AA GE, CSU GE, IGEC)

CHEM 104 C Physical Science for Teachers 4 Units

Prerequisite: MATH 020 C or MATH 041 C with minimum grades of “C”.
Term hours: 54 lecture and 54 laboratory. This activity-based course provides an introduction to the basic concepts of physical science with emphasis on their practical importance and application in the real world. Topics include global warming, the automobile, health, and energy. This course is intended for students who want to become primary school teachers. Duplicate credit not granted for PHSC 104 C. (CSU, AA GE, CSU GE, C-ID: PHYS 140 and C-ID: CHEM 140)

CHEM 107 C Preparation for General Chemistry 5 Units*Prerequisite: MATH 040 C or MATH 041 C with minimum grades of "C".*

Term hours: 72 lecture and 36 laboratory. This course provides a general introduction to the basic concepts, principles and laws of modern chemistry. Topics include a study of atomic theory, molecular structure, chemical reactivity, and the properties of the various phases of matter. Laboratory experiments include both qualitative and quantitative analysis, with an emphasis on proper laboratory techniques. This course applies to the physical science requirement for general education and is not acceptable for credit for students majoring in physical science. CHEM 107 C is a recommended preparatory course for students planning to take CHEM 111AC and CHEM 111BC. No credit if taken after CHEM 111AC. Pass/No Pass/Letter Grade Option (UC Credit Limitation/CSU, AA GE, CSU GE, IGETC)

CHEM 111AC General Chemistry I 5 Units*Prerequisite: MATH 040 C or MATH 041 C and CHEM 107 C with a grade of "C" or better, or a passing score on the Chemistry Proficiency Test.*

Term hours: 54 lecture and 36 discussion and 72 laboratory. Topics covered include the general principles of chemistry with associated laboratory analysis. This includes atomic structure, bonding, the mole concept, properties of solutions, gas laws, and thermochemistry. (UC/CSU, AA GE, CSU GE, IGETC, C-ID: CHEM 110, C-ID: CHEM 120S = CHEM 111AC + CHEM 111BC)

CHEM 111BC General Chemistry II 5 Units*Prerequisite: Completion of CHEM 111AC with a minimum grade of "C".*

Term hours: 72 lecture and 90 laboratory. Topics covered include the general principles of chemistry with associated laboratory analysis. This includes kinetics, equilibrium, thermodynamics, electrochemistry and nuclear chemistry. (UC Credit Limitation/CSU, AA GE, CSU GE, IGETC, C-ID: MATH 120S = CHEM 111AC + CHEM 111BC)

CHEM 112 C General Chemistry II for Engineers 4 Units*Prerequisite: Completion of CHEM 111AC with a grade of "C" or better.*

Term hours: 72 lecture. Topics covered include the general principles of chemistry. This includes kinetics, equilibrium, thermodynamics, electrochemistry and nuclear chemistry. (UC Credit Limitation/CSU)

CHEM 201 C Chemistry for Health Science Majors II 4 Units*Prerequisite: CHEM 101 C with a minimum grade of "C".*

Term hours: 54 lecture and 54 laboratory. This course is the second semester of a two-semester sequence (CHEM 101 C and CHEM 201 C). This course covers the structures, nomenclature, reactions, and applications of organic and biochemical compounds, as well as cell structure, metabolism, biotechnology, vitamins and enzymes. This course is designed for students majoring in health science. (UC/CSU, AA GE, CSU GE, IGETC)

CHEM 211AC Organic Chemistry I 5 Units*Prerequisite: CHEM 111BC with a grade of "C" or better.*

Term hours: 54 lecture and 36 discussion and 72 laboratory. This course is the first part of a two semester organic chemistry lecture and laboratory sequence. This course covers the study of functionalized compounds, stereochemistry, substitution and elimination reactions, alkenes, alkynes, and spectroscopic methods. Laboratory work includes the synthesis, isolation, and characterization of organic compounds by using modern techniques and instrumentation. This course is designed for students who plan to major in chemistry, biochemistry, biology, and medical/prepharmacy/pre dental programs. (UC/CSU, C-ID: CHEM 160S = CHEM 211AC + CHEM 211BC)

CHEM 211BC Organic Chemistry II 5 Units*Prerequisite: CHEM 211AC with a grade of "C" or better.*

Term hours: 54 lecture and 36 discussion and 72 laboratory. This course is the second part of a two semester organic chemistry lecture and laboratory sequence. The course includes the study of radicals, aromatic compounds, carbonyl-containing compounds, amines, biologically important compounds, and strategy in organic synthesis. Laboratory work includes modern techniques required to synthesize organic compounds, and the isolation and analysis of these compounds. This course is designed primarily for students who plan to major in chemistry, biochemistry, biology, and premedical/prepharmacy/pre dental programs. (UC/CSU, C-ID: CHEM 160S = CHEM 211AC + CHEM 211BC)

CHEM 298 C Chemistry Seminar .5 to 12 Units*Prerequisite: May be required.**Corequisite: May be required.**Advisory: May be required.*

Term hours: 0-216 lecture and 0-864 laboratory depending on units attempted. Seminars are designed to help students conceptualize and intensify knowledge in a variety of chemical topics. They may include lecture, discussions, and other activities at the discretion of the instructor. Actual seminar topics will be listed in the class schedule for a particular semester. Consult the class schedule to verify unit credit and prerequisites for a particular semester. Pass/No Pass or Pass/No Pass/Letter Grade Option or Standard Letter Grade. Fees may be required-Payable at Registration. (UC Credit Limitation/CSU)

Chinese

Division of Language Arts

Division Dean — Eldon Young*Faculty*

Hong Chi

Counselors

Therese Mosqueda-Ponce

Daniel Pelletier

PROGRAM LEARNING OUTCOMES (PLOs)

The courses taught by this department contribute to the General Education and Basic Skills Program Learning Outcomes. Please refer to General Education and Basic Skills Program Learning Outcomes.

CHINESE TRANSFER PROGRAM

Students should consult a counselor or www.assist.org for lower division major requirements for most California public universities. (See the Standard Definitions section of the catalog for a description of ASSIST.) Students transferring to an independent college/university should consult the catalog of the individual school and a counselor for lower division major requirements.

Chinese (CHIN)

CHIN 098 C Chinese Seminar

.5 to 12 Units

*Prerequisite: May be required.**Corequisite: May be required.**Advisory: May be required.*

Term hours: 0-216 lecture and 0-432 laboratory depending on units attempted. This seminar is for able students who wish to extend their knowledge of literature, language and culture through small group discussion. May be taken for credit 1-4 times. Pass/No Pass or Pass/No Pass/Letter Grade Option or Standard Letter Grade. Fees may be required-Payable at Registration.

CHIN 100 C Beginning Spoken Chinese

3 Units

Term hours: 54 lecture. This course is for students at beginning levels who would like to have exposure to Chinese without having to learn Chinese characters. It is an introduction to spoken Chinese with emphasis on pronunciation, oral practice, vocabulary development, and use of common expressions for daily conversations in a culturally appropriate way. Pass/No Pass/Letter Grade Option. (CSU, AA GE)

CHIN 101 C Elementary Chinese-Mandarin I

5 Units

Term hours: 90 lecture. The course emphasizes the acquisition of basic skills in pronunciation, listening, speaking, reading, and writing, and the grammar and vocabulary necessary to acquire these skills. Students will be introduced to customs, culture, and geography of China through lectures, films, and reading assignments. Pass/No Pass/Letter Grade Option. (UC/CSU, AA GE, CSU GE)

CHIN 102 C Elementary Chinese-Mandarin II

5 Units

Prerequisite: CHIN 101 C with a grade of "C" or better or one year of high school Chinese with a grade of "C" or better.

Term hours: 90 lecture. This course continues to emphasize the acquisition of basic skills in pronunciation, listening and speaking, reading, and writing, and the grammar and vocabulary necessary to acquire these skills. Students will increase their knowledge of the customs, culture, and geography of China and other Chinese speaking countries/areas through lectures, reading, writing assignments, and film. Pass/No Pass/Letter Grade Option. (UC/CSU, AA GE, CSU GE, IGETC)

CHIN 203 C Intermediate Chinese-Mandarin III

5 Units

Prerequisite: CHIN 102 C with a minimum grade of "C" or two years of high school Chinese with a grade of "C" or better.

Term hours: 90 lecture. This course develops listening, speaking, reading, and writing skills at the intermediate level, emphasizes both oral and written communication, and provides an expanded review of key grammatical concepts. Pass/No Pass/Letter Grade Option. (UC/CSU, AA GE, CSU GE)

CHIN 298 C Chinese Seminar

.5 to 12 Units

*Prerequisite: May be required.**Corequisite: May be required.**Advisory: May be required.*

Term hours: 0-216 lecture and 0-432 laboratory depending on units attempted. This seminar is for students who wish to extend their knowledge of literature, language and culture through small group discussion. Fees may be required-Payable at Registration. May be taken for credit 1-4 times. Pass/No Pass or Pass/No Pass/Letter Grade Option or Standard Letter Grade. (UC Credit Limitation/CSU)

Communications — See Journalism (JOUR)

Communication Studies

Division of Language Arts

Division Dean — Eldon Young

Faculty

Michael Brydges

Joshua House

Liana Koeppel

John Lambros

Jennifer Page

Counselors

Therese Mosqueda-Ponce

Daniel Pelletier

PROGRAM LEARNING OUTCOMES (PLOs)

The courses taught by this department contribute to the General Education and Basic Skills Program Learning Outcomes. Please refer to General Education and Basic Skills Program Learning Outcomes.

ASSOCIATE IN ARTS IN

COMMUNICATION STUDIES FOR

TRANSFER DEGREE (AA-T) Program Code: 1A31002

This curriculum is designed to provide an opportunity for the Communication Studies major to achieve an Associate in Arts Degree in Communication Studies for Transfer while completing the first and second year requirements for transfer to a four-year institution. While a baccalaureate degree is recommended preparation for those considering professional careers, completion of this curriculum will demonstrate commitment to the field and provide comprehensive preparation for upper division work.

The Student Transfer Achievement Reform Act (Senate Bill 1440, now codified in California Education Code sections 66746–66749) guarantees admission to a California State University (CSU) campus for any community college student who completes an “associate degree for transfer,” a newly established variation of the associate degrees traditionally offered at a California community college. The Associate in Arts for Transfer (AA-T) is intended for students who plan to complete a bachelor’s degree in a similar major at a CSU campus. Students completing these degrees (AA-T) are guaranteed admission to the CSU system, but not to a particular campus or major. Students transferring to a CSU campus that does accept the AA-T will be required to complete no more than 60 units after transfer to earn a bachelor’s degree (unless the major is designated “high-unit” major). This degree may not be the best option for students intending to transfer to a particular CSU campus or to a university or college that is not part of the CSU system. Students should consult with a counselor when planning to complete the degree for more information on university admission and transfer requirements.

To earn an Associate in Arts for Transfer (AA-T) students must complete: (1) a minimum of 18 units of major course requirements with a minimum grade of “C”; (2) California State University General Education Breadth requirements (CSU GE Breadth) or the Intersegmental General Education Transfer Curriculum (CSU IGETC); (3) any elective courses to complete a minimum of 60 units of CSU transferable course work; (4) have an overall GPA of 2.0.

| Required course | Units |
|---|-----------|
| COMM 100 C Human Communication or | 3 |
| COMM 100HC Honors Human Communication | (3) |
| Restricted Electives List A. Select 6 units. | |
| Students may choose from the following courses: | |
| COMM 105 C Interpersonal Communication | 3 |
| COMM 124 C Small Group Communication | 3 |
| COMM 135 C Argument and Critical Thinking | 3 |
| Restricted Electives List B. Select 6 Units. | |
| Students may choose from any course not used in List A and/or any of the following courses: | |
| (Forensics — maximum of 3 units) | |
| COMM 120 C Intercultural Communication | 3 |
| COMM 138 C Forensics | 1–2 |
| COMM 238 C Forensics | 1–2 |
| JOUR 110 C Global Media | 3 |
| Restricted Electives List C. Select 3 units. | |
| Students may choose from any course not used in Lists A or B or from any of the following courses: | |
| COMM 220 C The Rhetoric of the City | 3 |
| COMM 220HC Honors Rhetoric of the City | 3 |
| JOUR 101 C Reporting and Writing | 3 |
| PSY 101 C Introduction to Psychology | 3 |
| PSY 101HC Honors Introduction to Psychology | 3 |
| SOC 101 C Introduction to Sociology | 3 |
| SOC 101HC Honors Introduction to Sociology | 3 |
| ANTH 102 C Cultural Anthropology | 3 |
| ANTH 102HC Honors Cultural Anthropology | 3 |
| Total Units Required | 18 |

COMMUNICATION STUDIES TRANSFER PROGRAM

Students should consult a counselor or www.assist.org for lower division major requirements for most California public universities. (See the Standard Definitions section of the catalog for a description of ASSIST.) Students transferring to an independent college/university should consult the catalog of the individual school and a counselor for lower division major requirements.

Communication Studies (COMM)

COMM 049 C Oral Communication for Advanced Non-Native Speakers 3 Units

Term hours: 54 lecture. This course teaches the non-native speaker (NNS) of English effective communication techniques in everyday situations. Emphasis is placed on developing speaking skills such as pronunciation, articulation, organization and delivery. This course is especially helpful for students who have completed advanced courses in English as a Second Language. Pass/No Pass/Letter Grade Option.

COMM 050 C Effective Communication 3 Units

Term hours: 54 lecture. The course is designed to teach students effective communication techniques in everyday situations. Emphasis is placed on developing communication skills in a variety of settings including interviewing, resume building, public speaking and working in small groups. Pass/No Pass/Letter Grade Option. (AA GE)

COMM 098 C Communication Seminar 5 to 12 Units

Term hours: 0-216 lecture and 0-432 laboratory depending on units attempted. This seminar is for able students who wish to extend their knowledge of literature, language, and culture through small groups discussion. May be taken for credit 1-4 times. Pass/No Pass or Pass/No Pass/Letter Grade Option or Standard Letter Grade. Fee may be required - Payable at Registration.

COMM 100 C Human Communication 3 Units

Term hours: 54 lecture. Introduction to the fundamentals and principles which underlie effective speech communication. Practical experience, emphasizing content, organization and delivery, will be required in at least three speaking situations, specifically including persuasive and informative speaking. Duplicate credit not granted for COMM 100HC. (UC Credit Limitation/CSU, AA GE, CSU GE, IGETC, C-ID: COMM 110)

COMM 100HC Honors Human Communication 3 Units

Term hours: 54 lecture. Communication Studies 100HC is a college level course enhanced for Honors students. This course will introduce students to fundamentals and advanced principles which underlie effective speech communication and will offer an overview of the disciplinary field of speech communication. Enhanced practical applications, emphasizing content, organization, and delivery will be required in at least four speaking situations, specifically including persuasive and informative speaking. Principles of rhetorical criticism will also be studied. Duplicate credit not granted for COMM 100 C. (UC Credit Limitation/CSU, AA GE, CSU GE, IGETC, C-ID: COMM 110)

COMM 105 C Interpersonal Communication 3 Units

Advisory: Eligibility for ENGL 100 C.

Term hours: 54 lecture. The purpose of this course is to improve the students' understanding and the ability to deal effectively with people. Major theories in the field of interpersonal communication will be studied so the student can develop a basic understanding of those theories and also acquire skills for self improvement. Methods of instruction include lecture, discussion, simulation experiments, and small group activities. No formal speeches required. (CSU/CSU GE, C-ID: COMM 130)

COMM 120 C Intercultural Communication 3 Units

Advisory: Eligibility for ENGL 100 C.

Term hours: 54 lecture. This course focuses on the cultural and social variables, communication theories and practices, and communicative styles that affect the communication process between members of different cultures. It includes an assessment of both the communication problems that occur between members of different cultures and on methods and techniques of adapting communication in an effort to overcome such difficulties. (UC/CSU, CSU GE, IGETC, CUL DIV, C-ID: COMM 150)

COMM 124 C Small Group Communication 3 Units

Advisory: Eligibility for ENGL 100 C.

Term hours: 54 lecture. This course is an introduction to theoretical and applied concepts in small group communication through participation and observation, analysis, and evaluation of group processes. Elements of small group behavior to be studied include leadership, roles, norms, networks, conflict and cohesion needs, and decision making. (UC/CSU, C-ID: COMM 140)

COMM 135 C Argument and Critical Thinking 3 Units

Advisory: ENGL 060 C.

Term hours: 54 lecture. This course is a study of argumentation - logic, reasoning, analysis of issues, audience analysis, evidence, refutation, case construction - and its relationship to advocacy. Emphasis is placed on the development of critical thinking skills. (UC/CSU, AA GE, CSU GE, C-ID: COMM 120)

COMM 138 C Forensics 1 to 2 Units

Term hours: 36 lecture and 18 laboratory. This course is designed to prepare students to participate in intercollegiate speech competition. Practical experience, emphasizing content, organization and delivery will be offered in debate, persuasive speaking, informative speaking, extemporaneous speaking, impromptu speaking and oral interpretation. May be taken for credit 2 times. Open Entry/Open Exit. (CSU, CSU GE, C-ID: COMM 160B)

COMM 220 C The Rhetoric of the City 3 Units

Advisory: Eligibility for ENGL 100 C.

Term hours: 54 lecture. This course will examine the communicative meanings found in the culture, environment, history and social structure for a specific city. Students will be exposed to an interdisciplinary focus on a specific city and will examine the communicative interrelationship between the city and its populace. Duplicate credit not granted for COMM 220HC. (CSU, AA GE, CSU GE)

COMM 220HC Honors Rhetoric of the City 3 Units

Advisory: Eligibility for ENGL 100 C.

Term hours: 54 lecture. This course is a college level course enhanced for Honors students. This course will be conducted as a seminar. This course will examine the communicative meanings found in the culture, environment, history and social structure of a specific city. Students will be exposed to an interdisciplinary focus on a specific city and will examine the communicative interrelationships between the city and its populace. Duplicate credit will not be granted for COMM 220 C. (CSU, AA GE, CSU GE)

COMM 238 C Forensics 1 to 2 Units

Term hours: 36 lecture and 18 laboratory. This course is designed to prepare students to participate in intercollegiate speech competition. Practical experience, emphasizing content, organization and delivery will be offered in debate, persuasive speaking, informative speaking, extemporaneous speaking, impromptu speaking and oral interpretation. May be taken for credit 2 times. Open Entry/Open Exit. (CSU, CSU GE, C-ID: COMM 160B)

COMM 298 C Communication Studies Seminar .5 to 12 Units

Prerequisites: May be required.

Corequisite: May be required.

Advisory: May be required.

Term hours: 0-216 lecture and 0-432 laboratory depending on units attempted.

This seminar is for able students who wish to extend their knowledge of literature, language, and culture through small group discussion. May be taken for credit 1-4 times. Pass/No Pass or Pass/No Pass/Letter Grade Option or Standard Letter Grade. Fee may be required - Payable at Registration. (UC Credit Limitation/CSU)

COMM 299 C Communication Independent Study .5 to 2 Units

Prerequisite: Approved Independent Study Learning Contract.

Term hours: 9-36 conference depending on units attempted. This course is for able students who wish to increase their knowledge of speech/communication language through individual study or research. May be taken for credit 3 times. (UC Credit Limitation/CSU)

COMM 340 C Honors Rhetoric of the City 3 Units

Prerequisite: ENGL 100 C or ENGL 100HC with minimum grade of "C".

Advisory: COMM 100 C or COMM 100HC.

Term hours: 54 lecture. This course provides an integrative overview of communication for students in Mortuary Science. This course is designed to introduce students to advanced theories and principles of communication and to provide practical applications of those concepts. The course focuses on an in-depth utilization of those concepts in various communication settings.

Computer Information Systems

Division of Business and Computer Information Systems

Division Dean — Henry Hua

Faculty

Behzad Izadi
Susana Jianto
Richard McKnight
Alireza Moady
Peter Molnar
Patricia Pelachik
Donna Woo
Penn Wu

Counselor

Robert Grantham

PROGRAM LEARNING OUTCOMES (PLOs)

Computer Application

A student who completes the Computer Application field of study will be able to:

- Demonstrate the knowledge and skills to utilize operating system commands, emails, Internet use, digital storage media
- Use contemporary software application to create and modify word processing, spreadsheet, database, or presentation files
- Acquire computer application skills to enhance his/her employment opportunity

Computer Networking

A student who completes the Computer Networking field of study will be able to:

- Understand computer networking concepts including network security, and the operation of client and server computers and networking devices
- Acquire hands-on skills to configure, maintain, and troubleshoot client and server computers, and networking devices
- Enhance his/her employment opportunity in the specific area of computer networking

Computer Programming

A student who completes the Computer Programming field of study will be able to:

- Acquire problem analysis skills to design suitable solutions
- Code, debug, implement and maintain the computer programs
- Enhance his/her employment opportunity in the specific area of computer programming

Web Applications and Programming

A student who completes the Web Applications field of study will be able to:

- Demonstrate the knowledge and skills to employ the Internet tools to search the Web, manage email, communicate on the Web, download programs, share information, and strengthen Web security.
- Demonstrate the knowledge and skills to create and implement maintainable Websites using a range of programming techniques and languages.
- Demonstrate the knowledge and skills to apply a variety of Website management tools to maintain Websites.
- Enhance his/her employment opportunity in a specific area of Web applications programming.

ASSOCIATE IN SCIENCE IN BUSINESS ADMINISTRATION FOR TRANSFER DEGREE (AS-T) Program Code: 1S31295

This curriculum is designed to provide an opportunity for the Business Administration major to achieve an Associate in Science in Business Administration for Transfer Degree (AS-T in Business Administration) which completes the first and second year requirements for transfer into the CSU system.

Advanced degrees and/or professional certificates, such as a baccalaureate degree, are required for those considering professional careers. Completion of this curriculum will demonstrate a commitment to the field and provide comprehensive preparation for further academic study through upper-division course work. This curriculum specifically prepares the prospective transfer student for upper division course work in Business Administration or a similar major at a California State University (CSU) campus. Students should consult a counselor, the Transfer Center and the catalog of the transfer college or university to plan a specific program of study to meet the college or university's requirements. Note: Courses that fulfill major requirements for an Associate Degree for Transfer at Cypress College might not be the same as those required for completing the major at all transfer institutions offering a Baccalaureate Degree.

The Student Transfer Achievement Reform Act (Senate Bill 1440, now codified in California Education Code sections 66746–66749) guarantees admission to a California State University (CSU) campus for any community college student who completes an “associate degree for transfer,” a newly established variation of the associate degrees traditionally offered at a California community college. The AS-T is intended for students who plan to complete a bachelor's degree in a similar major at a CSU campus. Students completing these degrees (AS-T) are guaranteed admission to the CSU system, but not to a particular campus or major. Students transferring to a CSU campus that does accept the AS-T will be required to complete no more than 60 units after transfer to earn a bachelor's degree (unless the major is designated “high-unit” major). This degree may not be the best option for students intending to transfer to a particular CSU campus or to a university or college that is not part of the CSU system. Students should consult with a counselor when planning to complete the degree for more information on university admission and transfer requirements.

Students successfully completing the AS-T in Business Administration will gain knowledge in accounting, business communications, information technologies, finance, law, management, and marketing. Because business is such a broad field with many emphases and majors, this degree will provide the student a broad overview of the possible fields of study in various business areas.

To earn an AS-T in Business Administration students must complete the following requirements: (1) a minimum of 27 semester units or 40.5 quarter units in the Business Administration major with a minimum grade of “C”; (2) California State University General Education Breadth requirements (CSU GE Breadth) or the Intersegmental General Education Transfer Curriculum (CSU IGETC); (3) elective courses to complete a minimum of 60 units of CSU transferable course work; (4) have an overall GPA of 2.0.

Required Core Courses are listed in suggested sequence.

| (17 units) | | Units |
|---|--|--------------|
| ACCT 101 C | Financial Accounting | 4 |
| ACCT 102 C | Managerial Accounting | 4 |
| ECON 100 C | Principles of Economics — Macro | 3 |
| | or | |
| ECON 100HC | Honors Principles of Economics | (3) |
| ECON 105 C | Principles of Economics — Micro | 3 |
| | or | |
| ECON 105HC | Honors Principles of Economics | (3) |
| MGT 240 C | Legal Environment of Business | 3 |
| List A: Select one of the following: (4 units) | | Units |
| MATH 130 C | Survey of Calculus | 4 |
| MATH 120 C | Introduction to Probability and Statistics | 4 |
| MATH 115 C | Finite Mathematics | 4 |
| List B: Select two of the following or any courses from List A not already chosen. (6–8 units) | | Units |
| CIS 111 C | Computer Information Systems | 3 |
| MGT 161 C | Introduction to Business | 3 |
| | or | |
| MGT 211 C | Writing for Business | (3) |
| Total Units Required | | 27–29 |

ASSOCIATE IN SCIENCE DEGREE COMPUTER INFORMATION SYSTEMS

Program Code: 1S03767

This curriculum prepares the student for a career in the area of computer information systems. The program is designed to develop a working knowledge of what is required to be successful in business computer information systems.

To earn an Associate Degree students must complete: (1) all major course requirements with a minimum grade of “C”; (2) 25 units of General Education Graduation Requirements; (3) the cultural diversity and reading requirements; (4) any elective courses to complete a minimum of 60 units; and, (5) have a minimum GPA of 2.0. At least 50% of all major course work must be completed at Cypress College.

Courses that fulfill major requirements for an Associate Degree at Cypress College might not be the same as those required for completing the major at a transfer institution offering a Baccalaureate Degree. For information on specific university requirements, please consult with your counselor, or visit the Transfer Center.

Required courses are listed in suggested sequence:

| Course # | Title | Units |
|-----------------------------|---------------------------------|-----------|
| ACCT 101 C | Financial Accounting | 4 |
| CIS 111 C | Computer Information Systems | 3 |
| CIS 132 C | Spreadsheet — Excel for Windows | 3 |
| CIS 142 C | Database — Access for Windows | 3 |
| CIS 150 C | Microsoft Office Applications | 3 |
| CIS 160 C | Information Systems Management | 3 |
| CIS 211 C | Introduction to Programming | 3 |
| CIS 250 C | Word Processing | 2 |
| MGT 111 C | Business Communications | 3 |
| | or | |
| MGT 211 C | Writing for Business | (3) |
| Total Units Required | | 27 |

**ASSOCIATE IN SCIENCE DEGREE
COMPUTER
PROGRAMMING**

Program Code: 1S03768

This program prepares the student for a career in the area of computer programming. The curriculum is designed to develop a working knowledge of what is required to be successful in business computer programming.

To earn an Associate Degree students must complete: (1) all major course requirements with a minimum grade of “C”; (2) 25 units of General Education Graduation Requirements; (3) the cultural diversity and reading requirements; (4) any elective courses to complete a minimum of 60 units; and, (5) have a minimum GPA of 2.0. At least 50% of all major course work must be completed at Cypress College.

Courses that fulfill major requirements for an Associate Degree at Cypress College might not be the same as those required for completing the major at a transfer institution offering a Baccalaureate Degree. For information on specific university requirements, please consult with your counselor, or visit the Transfer Center.

Required courses are listed in suggested sequence:

| Course # | Title | Units |
|-----------------------------|------------------------------|-----------|
| CIS 111 C | Computer Information Systems | 3 |
| CIS 211 C | Introduction to Programming | 3 |
| CIS 217 C | Visual Basic Programming | 3 |
| CIS 223 C | Visual C++ Programming | 3 |
| CIS 226 C | Java Programming | 3 |
| CIS 218 C | Visual C# Programming | 3 |
| Total Units Required | | 18 |

**ASSOCIATE IN SCIENCE DEGREE
COMPUTER AND OFFICE
APPLICATIONS**

Program Code: 1S31209

The Associate in Science Degree Computer and Office Applications program provides theoretical and practical knowledge to students in the area of computer applications used in an office setting. This degree program focuses on recent computer applications used in a wide variety of government, academia, and business-related settings. This degree program is aimed at students who need to apply an understanding of computer applications to an on-the-job learning environment.

To earn an Associate Degree students must complete: (1) all major course requirements with a minimum grade of “C”; (2) 25 units of General Education Graduation Requirements; (3) the cultural diversity and reading requirements; (4) any elective courses to complete a minimum of 60 units; and, (5) have a minimum GPA of 2.0. At least 50% of all major course work must be completed at Cypress College.

Required Courses are listed in suggested sequence:

| Course # | Title | Units |
|-----------------------------|--|-----------|
| CIS 101 C | Introduction MS Word Document Formatting | 4 |
| CIS 102 C | Advanced MS Word Business Applications | 4 |
| CIS 103 C | Microsoft Excel and PowerPoint | 3 |
| CIS 150 C | Microsoft Office Applications | 3 |
| CIS 116 C | MS Outlook/Office Procedures | 3 |
| CIS 250 C | Word Processing | 2 |
| CIS 251 C | Advanced Word Processing | 2 |
| CIS 160 C | Information Systems Management | 3 |
| CIS 111 C | Computer Information Systems | 3 |
| CIS 121 C | Adobe PDF Document Management | 3 |
| Total Units Required | | 30 |

ASSOCIATE IN SCIENCE DEGREE

LAW OFFICE

ADMINISTRATION

Program Code: 1S32966

The Law Office Administration AS degree prepares the student for a career in the legal arena. The curriculum is designed to develop a working knowledge of the legal field. The objective of the Law Office Administration AS degree is to provide skill-based training through traditional teaching methods with an emphasis on practical and hands-on application of subject matter, along with a 40-hour internship in the field.

To earn an Associate Degree students must complete (1) all major course requirements with a minimum grade of “C”, (2) 25 units of General Education Graduation Requirements; (3) the cultural diversity and reading requirements; (4) any elective course to complete a minimum of 60 units; and (5) have a minimum GPA of 2.0. At least 50 percent of all major course work must be completed at Cypress College.

Required courses are listed in suggested sequence:

| Course # | Title | Units |
|-----------------------------|-------------------------------------|------------------|
| CTRP 073AC | Spelling for Modern Business | 1 |
| CTRP 073BC | Punctuation for Court Reporting | 1 |
| CTRP 071 C | Legal Terminology and Rhetoric | 3 |
| CTRP 072 C | Legal Procedures | 4 |
| MGT 055 C | Business English | 3 |
| MGT 143 C | Introduction to Legal Research | 1 |
| CTRP 067 C | Basic Vocabulary Development | 2 |
| CTRP 068 C | Advanced Vocabulary Development | 1.5 |
| CTRP 076 C | Court and Deposition Procedures | 0.5–3 |
| CTRP 073DC | Proofreading | 1 |
| CTRP 073CC | Formatting, Style and Usage | 1 |
| CTRP 062 C | Notary Public Exam Preparation | 0.5–1 |
| CTRP 080 C | Internship: Law Office | 2 |
| | or | |
| CTRP 033 C | Internship: Agency Services | (2) |
| | or | |
| CTRP 034 C | Internship: Court Services | (2) |
| MGT 240 C | Legal Environment of Business | 3 |
| | or | |
| MGT 241 C | Legal Aspects-Business Transactions | (3) |
| Total Units Required | | 24.5–27.5 |

ADVANCED NETWORKING CERTIFICATE

Program Code: 1C30332

This curriculum focuses on advanced networking concepts such as network security, Microsoft Networking, voice over IP, network virtualization and emerging technologies. Special emphasis is on developing hands-on skills with advanced networking equipment.

To earn a certificate, complete the required courses as listed with a minimum grade of "C." At least 50% of all course work must be completed at Cypress College.

| Take 4 of the following courses: | | Units |
|----------------------------------|--|-----------|
| CIS 202 C | VMware Virtualization Network | 3 |
| CIS 239 C | CCNA Bootcamp | 3 |
| CIS 240 C | Wireless Networking Technology | 3 |
| CIS 248 C | Voice Over IP | 3 |
| CIS 257 C | Storage Management and Cloud Computing | 3 |
| CIS 258 C | CCNA Security | 3 |
| Total Units Required | | 12 |

CISCO NETWORKING CERTIFICATE

Program Code: 1C12937

This curriculum prepares the students for a career in the area of computer networking. The program is designed to teach students the skills needed to design, build, and maintain small to medium-size networks. The certificate totals 12 units in required courses.

To earn a certificate, complete the required courses as listed with a minimum grade of "C." At least 50% of all course work must be completed at Cypress College.

Required courses are listed in suggested sequence:

| Course # | Title | Units |
|-----------------------------|--------------------|-----------|
| CIS 230 C | Cisco Networking 1 | 3 |
| CIS 231 C | Cisco Networking 2 | 3 |
| CIS 232 C | Cisco Networking 3 | 3 |
| CIS 233 C | Cisco Networking 4 | 3 |
| Total Units Required | | 12 |

COMPUTER FORENSICS CERTIFICATE

Program Code: 1C30328

The goal of this program is to equip students with the necessary skills and knowledge required to collect digital artifacts and present them to related parties as digital evidence. Students will learn how to process cases from start to finish in addition to the use of software toolkits.

To earn a certificate, complete the required courses as listed with a minimum grade of "C." At least 50% of all course work must be completed at Cypress College.

Students who successfully complete the following required courses are eligible for applying for certification in Computer Forensics:

| Take all of the following required courses: | | Units |
|--|----------------------------------|--------------|
| CIS 277 C | Computer Forensics II | 3 |
| CIS 278 C | Cyber Crime | 3 |
| CIS 279 C | Computer Forensics Legal Aspects | 3 |
| CIS 280 C | Analysis of Digital Media | 3 |
| CIS 281 C | Computer Forensics Capstone | 3 |
| Take a total of 3 units from the following courses: | | Units |
| CIS 271 C | Computer Forensics in Practice | 1 |
| CIS 272 C | Computer Forensics New Challenge | 1 |
| CIS 273 C | Computer Forensics Tools | 1 |
| CIS 276 C | Computer Forensics I | 3 |
| Total Units Required | | 18 |

COMPUTER AND OFFICE APPLICATIONS CERTIFICATE

Program Code: 1C31193

This curriculum gives the student a working knowledge for a career in computer applications in an office setting. Upon completion, the student will work in the capacity of office assistant, computer application specialist, or administrative assistant.

To earn a certificate, students must complete the required courses as listed with a minimum of "C" grade. At least 50% of all course work must be completed at Cypress College.

| Required Courses are listed in suggested sequence: | | Units |
|--|--|-----------|
| CIS 101 C | Introduction MS Word Document Formatting | 4 |
| CIS 102 C | Advanced MS Word Business Applications | 4 |
| CIS 103 C | Microsoft Excel and PowerPoint | 3 |
| CIS 150 C | Microsoft Office Applications | 3 |
| CIS 116 C | MS Outlook/Office Procedures | 3 |
| CIS 160 C | Information Systems Management | 3 |
| CIS 250 C | Word Processing | 2 |
| CIS 251 C | Advanced Word Processing | 2 |
| Total Units Required | | 24 |

COMPUTER PROGRAMMING CERTIFICATE

Program Code: 1C21106

This program prepares the student for a career in the area of computer programming. The program is designed to develop a working knowledge of what is required to be successful in business computer programming.

To earn a certificate, students must complete the required courses as listed with a minimum grade of "C." At least 50% of all course work must be completed at Cypress College.

| Course # | Title | Units |
|--|------------------------------|-----------|
| Required 2 core courses are listed in suggested sequence: | | |
| CIS 111 C | Computer Information Systems | 3 |
| CIS 211 C | Introduction to Programming | 3 |
| Select 2 of the following courses: | | |
| CIS 218 C | Visual C# Programming | 3 |
| CIS 223 C | Visual C++ Programming | 3 |
| CIS 226 C | Java Programming | 3 |
| Total Units Required | | 12 |

COMPUTER SOFTWARE AND APPLICATION CERTIFICATE **Program Code: 1C31196**

This certificate focuses on introductory business software applications used to manage and format information in word processing, in a spreadsheet or database, for desktop publishing, on the Internet, or as a Web page. Students apply their software application knowledge to on-the-job learning situations.

To earn a certificate, complete the required courses as listed with a minimum grade of “C.” At least 50% of all course work must be completed at Cypress College.

| Required courses are listed in suggested sequence: | | Units |
|---|---|--------------|
| CIS 100 C | Introduction to Computer and Windows Concepts | 3 |
| CIS 101 C | Introduction MS Word Document Formatting | 4 |
| CIS 150 C | Microsoft Office Applications | 3 |
| CIS 250 C | Word Processing | 2 |
| CIS 115 C | Desktop Publishing — Publisher or | 2 |
| CIS 075 C | Business Skills Development | (2) |
| CIS 103 C | Microsoft Excel and PowerPoint | 3 |
| CIS 121 C | Adobe PDF Document Management | 3 |
| Total Units Required | | 20 |

CYBER SECURITY CERTIFICATE **Program Code: 1C33780**

This curriculum prepares students to recognize Cyber Security threats and implement procedures to protect computers, networks, programs and data from unintended or unauthorized access, change or destruction. It will also enhance students’ chances to pursue a professional career in Cyber Security by preparing them for industry-recognized certificates such as SSCP, Security + and CCNA Security. To earn a certificate, complete the required courses as listed with a minimum grade of “C”. At least 50% of all course work must be completed at Cypress College.

| Take 4 of the following courses | | Units |
|--|----------------------------------|--------------|
| CIS 195 C | Network Security | 3 |
| CIS 196 C | Anti-Hacking Network Security | 3 |
| CIS 230 C | Cisco Networking 1 | 3 |
| CIS 258 C | CCNA Security | 3 |
| CIS 279 C | Computer Forensics Legal Aspects | 3 |
| Total Units Required | | 12 |

DATABASE MANAGEMENT CERTIFICATE **Program Code: 1C32702**

This program is designed to develop a working knowledge of what is required to be successful in business using Database Management Software. To earn a certificate, complete the required courses as listed with a minimum grade of “C.” At least 50% of all course work must be completed at Cypress College.

| Required courses are listed in suggested sequence: | | Units |
|---|--------------------------------------|--------------|
| CIS 111 C | Computer Information Systems | 3 |
| CIS 142 C | Database — Access for Windows | 3 |
| CIS 242 C | Database — Advanced MS Access | 3 |
| CIS 236 C | Introduction to Oracle: SQL & PL/SQL | 3 |
| Total Units Required | | 12 |

GAME PROGRAMMING CERTIFICATE **Program Code: 1C31197**

The Game Programming certificate is designed for students who wish to learn the essential game programming skills to get started in the exciting world of computer game software. Upon the completion of all required courses students will have the basic skills required to create gaming environments and scenarios.

To earn a certificate, complete the required courses as listed with a minimum grade of “C.” At least 50% of all course work must be completed at Cypress College.

| Take all of the following courses: | | Units |
|---|-----------------------------|--------------|
| CIS 211 C | Introduction to Programming | 3 |
| CIS 260 C | Game Concepts Development | 3 |
| CIS 261 C | Game Programming | 3 |
| Take one of the following courses: | | Units |
| CIS 244 C | Java Game Programming | 3 |
| CIS 264 C | Windows Game Programming | 3 |
| Take one of the following courses: | | Units |
| CIS 263 C | Mobile Game Programming | 3 |
| CIS 265 C | 3D Game Programming | 3 |
| Total Units Required | | 15 |

JAVA PROGRAMMING CERTIFICATE **Program Code: 1C33100**

This program is designed to provide students with the programming skills they need to work as programmers in the Information Technology department. It covers such key areas as Java programming, Web programming, mobile application development and maintaining the current program used in the information technology department. The goals and objectives are to: 1) enable students to acquire problem analysis skills to design suitable solutions; 2) enable students to code, debug, implement and maintain the computer programs; 3) enhance student’s employment opportunity in the specific area of computer programming. Student learning outcomes: students who complete the program will 1) know how to code, debug, implement and maintain computer programs effectively; and 2) organize and analyze an overall project to reach a suitable solution.

There are no prerequisites or limitations on enrollment for this program. Among the potential careers it will prepare students for are: computer programmer; computer program analyst, and computer support. Java programming is a growing field since it is widely used in the mobile application areas. To stay competitive in it, workers need to keep their skills updated. To earn a certificate, students must complete the required courses as listed with a minimum grade of “C.” At least 50 percent of all course work must be completed at Cypress College.

| Required courses are listed in suggested sequence. | | Units |
|---|------------------------------|--------------|
| CIS 111 C | Computer Information Systems | 3 |
| CIS 211 C | Introduction to Programming | 3 |
| CIS 226 C | Java Programming | 3 |
| CIS 234 C | Advanced Java Programming or | 3 |
| CIS 252 C | Java Web Applications | (3) |
| Total Units Required | | 12 |

**MICROSOFT EXCEL
CERTIFICATE****Program Code: 1C32628**

This program is designed to develop a working knowledge of what is required to be successful in business using Microsoft Excel. To earn a certificate, complete the required courses as listed with a minimum grade of "C." At least 50% of all course work must be completed at Cypress College.

| Required courses are listed in suggested sequence. | | Units |
|--|---------------------------------|-----------|
| CIS 111 C | Computer Information Systems | 3 |
| CIS 132 C | Spreadsheet — Excel for Windows | 3 |
| CIS 211 C | Introduction to Programming | 3 |
| CIS 241 C | Spreadsheet — Advanced MS Excel | 3 |
| Total Units Required | | 12 |

**MICROSOFT NETWORKING
CERTIFICATE****Program Code: 1C30331**

This certificate program prepares students for a certificate in the administration of a Microsoft network in today's businesses. This program includes skills in planning, designing, implementing, and managing a Microsoft network. It is intended for those individuals who need to gain skills in day-to-day general network administration, configuration, and support tasks.

To earn a certificate, students must complete the required courses as listed with a minimum grade of "C." At least 50% of all course work must be completed at Cypress College.

| Required courses are listed in suggested sequence: | | Units |
|--|--|-----------|
| Course # | Title | |
| CIS 182 C | Data Communications Management | 3 |
| CIS 185 C | Microsoft Client/Server Administration | 3 |
| CIS 189 C | MS Windows Active Directory | 3 |
| CIS 191 C | Network Infrastructure Administration | 3 |
| CIS 187 C | MS Windows Exchange Server | 3 |
| Total Units Required | | 15 |

**MOBILE APPLICATION DEVELOPMENT
CERTIFICATE****Program Code: 1C35416**

This program is designed to develop a working knowledge of what is required to be successful in creating Mobile Applications for business uses. The curriculum consists of Introduction to Programming, beginning Java and various Java related courses. To earn a certificate, complete the required courses as listed with a minimum grade of "C". At least 50% of all course work must be completed at Cypress College.

| Required courses are listed in suggested sequence: | | Units |
|--|----------------------------------|-----------|
| CIS 211 C | Introduction to Programming | 3 |
| CIS 226 C | Java Programming | 3 |
| CIS 244 C | Java Game Programming | 3 |
| | or | |
| CIS 252 C | Java Web and Mobile Applications | (3) |
| CIS 254 C | Mobile Application Development | 3 |
| Total Units | | 12 |

**NETWORK VIRTUALIZATION
CERTIFICATE****Program Code: 1C31329**

This certificate is designed to provide students with the key virtualization techniques and the applications of virtualization technology in the design, planning, implementation, management, and evaluation of virtualized enterprise infrastructure including computational clouds. The certificate covers recent trends in virtualization including the current wave of virtualization technology from both VMware and Microsoft.

To earn a certificate, complete the required courses as listed with a minimum grade of "C." At least 50% of all course work must be completed at Cypress College.

| Required courses are listed in suggested sequence: | | Units |
|--|--|-----------|
| CIS 185 C | Microsoft Client/Server Administration | 3 |
| CIS 189 C | MS Windows Active Directory | 3 |
| CIS 201 C | MS Virtualization Network | 3 |
| CIS 202 C | VMware Virtualization Network | 3 |
| Total Units Required | | 12 |

**OFFICE ASSISTANT
CERTIFICATE****Program Code: 1C31199**

To prepare students for a variety of occupational office positions with a basic understanding of computer software.

To earn a certificate, complete the required courses as listed with a minimum grade of "C." At least 50% of all course work must be completed at Cypress College.

| Required courses are listed in suggested sequence: | | Units |
|--|---|-----------|
| CIS 100 C | Introduction to Computer and Windows Concepts | 3 |
| CIS 101 C | Introduction MS Word Document Formatting | 4 |
| CIS 150 C | Microsoft Office Applications | 3 |
| CIS 116 C | MS Outlook/Office Procedures | 3 |
| Total Units Required | | 13 |

**PC/NETWORK HARDWARE SUPPORT
CERTIFICATE****Program Code: 1C30330**

This certificate is intended for those individuals who need to gain hands-on practice and competency in core hardware related to both PC and network operating system technologies. Upon completion of all required courses, students will be able to recognize major personal computer components including their functions, and configure the most common technical problems associated with a personal computer in both stand-alone and networking platforms. Special emphasis is focused on hands-on skills with PC hardware and software installation and troubleshooting in a networked environment.

To earn a certificate, complete the required courses as listed with a minimum grade of "C." At least 50% of all course work must be completed at Cypress College.

| Required courses are listed in suggested sequence: | | Units |
|--|----------------------------------|-----------|
| CIS 161 C | PC Operating System | 3 |
| CIS 162 C | PC Hardware Configurations | 3 |
| CIS 163 C | Introduction to Network Hardware | 3 |
| CIS 164 C | Computer Desktop Support | 3 |
| Total Units Required | | 12 |

PROJECT MANAGEMENT CERTIFICATE

Program Code: 1C32627

The Project Management Certificate is designed to help students: (A) Understand the role and functions of the project manager; (B) Plan and manage projects using Microsoft Project software, Work Breakdown Structures, Gantt charts, and PERT charts; (C) Manage project time, budget, and project team more effectively; (D) Apply these tools immediately by completing a project plan and budget as part of the course of study.

| | | Units |
|-----------|---------------------------------|--------------|
| CIS 274 C | Project Management Fundamentals | 3 |
| CIS 216 C | Microsoft Project | 3 |
| MKT 222 C | Principles of Marketing | 3 |
| MGT 262 C | Principles of Management | 3 |
| | or | |
| MGT 266 C | Human Relations in Business | (3) |
| | Total Units Required | 12 |

SOCIAL MEDIA

MARKETING CERTIFICATE Program Code: 1C32651

This program is designed for students to use social media tools to introduce and promote new products, enhance customer service, and obtain marketing research information. The curriculum focuses on principles of marketing, advertising and consumer behavior and Internet and web technologies as related to social media. To earn a certificate, students will complete the required courses as listed with a minimum grade of "C." At least 50% of all course work must be completed at Cypress College.

| | | Units |
|--|---------------------------------|--------------|
| Required courses are listed in suggested sequence | | |
| CIS 120 C | Internet and Social Media | 3 |
| CIS 221 C | Web Technology and Social Media | 3 |
| MKT 222 C | Principles of Marketing | 3 |
| MKT 103 C | Principles of Advertising | 3 |
| | or | |
| MKT 210 C | Consumer Behavior | (3) |
| | Total Units Required | 12 |

TECHNOLOGY MANAGEMENT CERTIFICATE

Program Code: 1C33101

This program is designed to provide students with the technical and administrative skills they need to manage workers and information in a computerized business office. It covers such key areas as the global business environment, human resource management, information systems, data communications, and project management. The goals and objectives are to: 1) equip students with the necessary skills to carry out management functions in a technological workplace; 2) utilize modern office information technology systems; and 3) work productively in a global marketplace. Student learning outcomes: students who complete the program will 1) know how to use office information technology effectively; and 2) how to employ the universal management functions (planning, organizing, directing and controlling) to lead and motivate.

There are no prerequisites or limitations on enrollment for this program. Among the potential careers it will prepare students for are: computer information systems manager; network computer systems administrator, and technology management specialist. Technology management is a growing field. To stay competitive in it, though, workers need to keep their skills updated. At least 50 percent of all course work must be completed at Cypress College.

| | | Units |
|---|---------------------------------|--------------|
| Required courses are listed in suggested sequence: | | |
| CIS 160 C | Information Systems Management | 3 |
| | or | |
| CIS 182 C | Data Communications Management | (3) |
| CIS 274 C | Project Management Fundamentals | 3 |
| MGT 161 C | Introduction to Business | 3 |
| MGT 262 C | Principles of Management | 3 |
| | or | |
| MGT 266 C | Human Relations in Business | (3) |
| | Total Units Required | 12 |

VISUAL C PROGRAMMING

CERTIFICATE Program Code: 1C33102

This program is designed to provide students with the programming skills they need to work as programmers in the Information Technology department. It covers such key areas as Visual C# programming, Visual C++ programming, mobile application development and maintaining the current program used in the information technology department. The goals and objectives are to: 1) enable students to acquire problem analysis skills to design suitable solutions; 2) enable students to code, debug, implement and maintain the computer programs; 3) enhance student's employment opportunity in the specific area of computer programming. Student learning outcomes: students who complete the program will 1) know how to code, debug, implement and maintain computer programs effectively; and 2) organize and analyze an overall project to reach a suitable solution.

There are no prerequisites or limitations on enrollment for this program. Among the potential careers it will prepare students for are: computer programmer; computer program analyst, and computer support. Visual C# and Visual C++ programming is a growing field since it is widely used in the APPS and mobile application areas. To stay competitive in it, workers need to keep their skills updated. To earn a certificate, students must complete the required courses as listed with a minimum grade of "C." At least 50 percent of all course work must be completed at Cypress College.

| | | Units |
|---|------------------------------|--------------|
| Required courses are listed in suggested sequence: | | |
| CIS 111 C | Computer Information Systems | 3 |
| CIS 211 C | Introduction to Programming | 3 |
| CIS 218 C | Visual C# Programming | 3 |
| CIS 223 C | Visual C++ Programming | 3 |
| | Total Units Required | 12 |

**WEB DEVELOPMENT
CERTIFICATE****Program Code: 1C30334**

This certificate focuses on the current development in Web page technologies used in academia and the business industry. This certificate prepares students to design and modify Web pages using current software programs or programming languages and apply their knowledge to on-the-job learning situations.

To earn a certificate, students will complete the required courses as listed with a minimum grade of "C." At least 50% of all course work must be completed at Cypress College.

| Required courses are listed in suggested sequence: | | Units |
|---|---------------------------------|--------------|
| CIS 109 C | E-Business Applications | 3 |
| CIS 179 C | Introduction to Web Page Design | 3 |
| CIS 211 C | Introduction to Programming | 3 |
| Take one of the following courses: | | |
| CIS 220 C | Web Page Programming | 3 |
| | or | |
| CIS 262 C | New Technology | (3) |
| Total Units Required | | 12 |

**WEB NETWORKING TECHNOLOGY
CERTIFICATE****Program Code: 1C30329**

The Web Networking Technology Certificate is designed to prepare students with the focused knowledge and understanding of collaborative Web technologies. The curriculum covers the use of the Internet to enhance interconnectivity and interactivity of Web-delivered contents including information sharing, social networking, publishing and posting information on the Web, and Web feed and services.

To earn a certificate, complete the required courses as listed with a minimum grade of "C". At least 50% of all course work must be completed at Cypress College.

| Required courses are listed in suggested sequence: | | Units |
|---|---------------------------------|--------------|
| CIS 120 C | Internet and Social Media | 3 |
| CIS 121 C | Adobe PDF Document Management | 3 |
| CIS 221 C | Web Technology and Social Media | 3 |
| CIS 262 C | New Technology | 3 |
| Total Units Required | | 12 |

**WEB PROGRAMMING
CERTIFICATE****Program Code: 1C30335**

This certificate offers advanced and latest programming technologies in the making of Web applications. It focuses less on content and more on coding. Students will learn how to develop programs and scripts for Web applications and implementation of dynamic web pages includes a study of various languages and database access. This certificate is designed for students who need to apply for positions such as Web Programmer, Web Master, Web Page Designer, Marketing and Advertising Coordinator, and Web Technical Support.

To earn a certificate, complete the required courses as listed with a minimum grade of "C." At least 50% of all course work must be completed at Cypress College.

| Take one of the following courses: | | Units |
|---|----------------------------------|--------------|
| CIS 220 C | Web Page Programming | 3 |
| CIS 227 C | Java Script Programming and AJAX | 3 |
| Take one of the following courses: | | Units |
| CIS 225 C | Web Programming with ASP | 3 |
| CIS 246 C | PHP Programming | 3 |
| Take one of the following courses: | | Units |
| CIS 245 C | Perl Programming | 3 |
| CIS 247 C | Python Programming | 3 |
| Take one of the following courses: | | Units |
| CIS 229 C | Introduction to XML Programming | 3 |
| CIS 262 C | New Technology | 3 |
| Total Units Required | | 12 |

**COMPUTER INFORMATION SYSTEMS
TRANSFER PROGRAM**

Students should consult a counselor or www.assist.org for lower division major requirements for most California public universities. (See the Standard Definitions section of the catalog for a description of ASSIST.) Students transferring to an independent college/university should consult the catalog of the individual school and a counselor for lower division major requirements.

Computer Information Systems (CIS)**CIS 075 C Business Skills Development .5 to 10 Units**

Term hours: 9-180 lecture and 54-540 laboratory TBA depending on units attempted. This variable unit, open entry/open exit course with flexible hours is designed for the student who needs to gain marketable job skills in a short period of time. Occupational training will be provided in the areas of computer applications, information processing, office occupations, and communication skills. May be taken for a cumulative total of 10 units. Open Entry/Open Exit. Pass/No Pass/Letter Grade Option. \$3.00 Materials Fee-Payable at Registration.

**CIS 100 C Introduction to Computer and
Windows Concepts 3 Units**

Formerly CIS 050 C

Term hours: 54 lecture and 18 laboratory. This course is designed to teach the computer hardware, Windows Operating System, E-mail, Web Apps, and Internet concepts. Students will receive hands-on experience. \$3.00 Materials Fee--PAYABLE AT REGISTRATION. Pass/No Pass/Letter Grade Option. (CSU)

CIS 101 C Introduction MS Word/ Document Formatting**4 Units**

Term hours: 54 lecture and 54 laboratory. Students will learn to build speed and accuracy using the touch method and learn to format letters, table, memos, and reports using Microsoft Word. Pass/No Pass/Letter Grade Option. \$3.00 Materials Fee-Payable at Registration. (CSU)

CIS 102 C Advanced MS Word Business Applications**4 Units**

Term hours: 54 lecture and 54 laboratory. This course teaches the student how to create and format business, legal and medical documents using Microsoft Word. Focus will be on using Word features such as mail merge, styles, graphics, etc. to generate letters, tables, reports and newsletters. Pass/No Pass/Letter Grade Option. \$3.00 Material Fee-Payable at Registration. (CSU)

CIS 103 C Microsoft Excel and PowerPoint**3 Units**

Advisory: CIS 101 C, or consent of instructor.

Term hours: 36 lecture and 54 laboratory. This course teaches the student how to use Excel and PowerPoint for business and professional use. This course provides the student with the knowledge and skills necessary to take the Core level Microsoft Office Specialist Excel and Comprehensive PowerPoint exams. Pass/No Pass/Letter Grade Option. \$3.00 Material Fee-Payable at Registration. (CSU)

CIS 107 C Introduction to Windows**2 Units**

Term hours: 36 lecture and 18 laboratory. This course is designed to use Microsoft Windows on the personal computer. It covers the graphical user interface, and how to manipulate Windows, using Help, and launching Applications. \$3.00 Materials Fee-Payable at Registration. (CSU)

CIS 109 C E-Business Applications**3 Units**

Term hours: 54 lecture and 18 laboratory. This course introduces the technological infrastructure needed for implementing e-Business solutions. It also discusses the software components necessary to implement such applications. A major component of the course will be hands-on projects of evaluating e-business tools and application software. \$3.00 Material Fee-Payable at Registration. (CSU)

CIS 110 C Linux Operating System**3 Units**

Term hours: 54 lecture and 18 laboratory. This course is an introduction to the Linux operating system. Topics include installing, configuring, maintaining, administering, and troubleshooting of the Linux Operating System. It provides preparation for the Sair Linux Certification. \$3.00 Materials Fee-Payable at Registration. (CSU)

CIS 111 C Computer Information Systems**3 Units**

Term hours: 48-54 lecture and 16-18 laboratory. This course is an introduction to computer concepts, computer organization, operation, hardware, systems and application software; business-problem solving; and applications to business. \$3.00 Material Fee - Payable at Registration. (UC/CSU, AA GE, CSU GE, C-ID: ITIS 120 + C-ID BUS 140)

CIS 115 C Desktop Publishing - Publisher**2 Units**

Term hours: 36 lecture and 18 laboratory. This class is designed for office support staff, secretaries, administrative assistants, small business owners, and others who require a basic knowledge of business desktop publication applications. This course uses Microsoft Office Publisher. May be taken for credit 3 times. Pass/No Pass/Letter Grade Option. \$3.00 Material Fee-Payable at Registration. (CSU)

CIS 116 C MS Outlook/Office Procedures**3 Units**

Term hours: 54 lecture and 18 laboratory. This course prepares management or office personnel for work in a computerized office environment. MS Outlook is taught in this class and integrated with Word and other MS office applications. Pass/No Pass/Letter Grade Option, \$3.00 Material Fee - Payable at Registration. (CSU)

CIS 120 C Social Media and Digital Marketing**3 Units**

Term hours: 54 lecture and 18 laboratory. This course provides in-depth coverage of social media and marketing within social media networks, as well as current methods and techniques for conducting business on the Internet. Students will learn real world Internet business and social media technical and marketing skills. Other topics covered include Search Engine Optimization, Digital Security and Ethics, Electronic Commerce and Online Advertising concepts. Pass/No Pass/Letter Grade Option. \$3.00 Material Fee - Payable at Registration. (CSU)

CIS 121 C Adobe PDF Document Management**3 Units**

Term hours: 36 lecture and 54 laboratory. This class is designed to teach students to use Adobe Acrobat Professional to convert technical documents to PDF (Portable Document Format) files. Students will prepare, edit, and format PDF documents, enhance and control PDF accessibility features, create interactive documents that can be shared via email and the Web, and prepare PDF documents for commercial printing. \$3.00 Materials Fee-Payable at Registration. (CSU)

CIS 132 C Spreadsheet-Excel for Windows**3 Units**

Term hours: 54 lecture and 18 laboratory. This course is designed to introduce students to the use of spreadsheet programs in the solution of problems. Students will use spreadsheet software to create, edit, graph, save, and print out spreadsheets. \$3.00 Material Fee-Payable at Registration. (CSU)

CIS 142 C Database-Access for Windows**3 Units**

Term hours: 54 lecture and 18 laboratory. This course is designed to introduce the student to the use of database programs in the solution of record keeping problems. Students will use database software to create, update, and report data files. \$3.00 Material Fee - Payable at Registration. (CSU)

CIS 150 C Microsoft Office Applications**3 Units**

Term hours: 54 lecture and 18 laboratory. This course studies the terms, concepts, and features of Microsoft Office software in today's business office. Students will create hands-on application office projects using Microsoft Office. Pass/No Pass/Letter Grade Option. \$3.00 Material Fee-Payable at Registration. (CSU)

CIS 160 C Information Systems Management**3 Units**

Term hours: 54 lecture and 32 laboratory. This course is for students interested in managing a Computer Information Systems Center. The subject areas to be studied are planning, equipping, staffing, and managing a computerized business office. The student will use a computer spreadsheet and database in hands-on exercises in planning and managing an information systems office. Pass/No Pass/Letter Grade Option. \$3.00 Materials Fee-Payable at Registration. (CSU)

CIS 161 C PC Operating System**3 Units**

Term hours: 36 lecture and 54 laboratory. The course uses the latest version of Windows to introduce students to the technical aspects of an operating system program. This course takes students from the fundamental concepts of modern computer operating systems, and leads them into more advanced topics and network implementation. Topics include installing, configuring, upgrading, diagnosing, and troubleshooting desktop operating systems. Pass/No Pass/Letter Grade Option. \$3.00 Material Fee - Payable at Registration. (CSU)

CIS 162 C PC Hardware Configurations**3 Units**

Term hours: 54 lecture and 18 laboratory. This course prepares students with both theoretical and practical lessons relating to Microcomputer hardware. Emphasis is placed on how hardware components function together to make a Microcomputer work properly, how software interacts with hardware, and practical methods to protect hardware and software. Topics include installing, configuring, and upgrading personal computer components and peripherals in a networked environment. Pass/No Pass/Letter Grade Option. \$3.00 Material Fee-Payable at Registration. (CSU)

CIS 163 C Introduction to Network Hardware 3 Units*Advisory: CIS 162 C or consent of instructor.*

Term hours: 54 lecture and 18 laboratory. This course builds on students' knowledge of basic networking concepts and theory through hands-on experience. The course will provide students with an in-depth understanding of network infrastructure, standards, and technologies. Students will gain hands-on experience with current network design issues, protocol, and components. Hands-on experience will also include working with wired and wireless standards and network components such as servers, routers, switches, hubs, and firewalls. Pass/No Pass/Letter Grade Option. \$3.00 Material Fee - Payable at Registration. (CSU)

CIS 164 C Computer Desktop Support 3 Units

Term hours: 36 lecture and 54 laboratory. This class is designed to teach students the crucial skills needed to work as a computer end-user support in an Active Directory network environment or Windows workgroup environment as well as how to troubleshoot applications running in Microsoft Windows platform. Students will learn the kinds of knowledge, skills, abilities, and strategies they need to be employable in the support industry. Emphasis will be placed on end-user computing, communication and customer service skills of user support staff, problem solving strategies, common support problems, and technical skills required for user support positions. This course prepares students for the Microsoft Certified Desktop Support Technician curriculum (MCDST). Pass/No Pass/Letter Grade Option. \$3.00 Material Fee-Payable at Registration. (CSU)

CIS 179 C Introduction to Web Page Design 3 Units

Term hours: 54 lecture and 18 laboratory. This course introduces students to Web publishing with HTML (Markup Language) for business and personal applications. Students will learn techniques to design a professional-looking Web site. Emphasis is placed on learning the HTML from the basic tags to the advanced topics such as tables, graphics, cascading style sheets, and creation of the business-related Web pages. Pass/No Pass/Letter Grade Option. \$3.00 Material Fee-Payable at Registration. (CSU)

CIS 182 C Microsoft Networking Fundamentals 3 Units

Term hours: 54 lecture and 18 laboratory. The course provides a comprehensive introduction of the fundamental concepts and theory of Microsoft networking. Students will understand network infrastructures, network hardware, and protocols and services. Topics include communication concepts, communication components and hardware, communication media, topologies, protocols, local and wide area networks, wireless communications, and Windows related network administration commands. Pass/No Pass/Letter Grade Option. \$3.00 Material Fee - Payable at Registration. (CSU)

CIS 185 C Administering Windows Server 3 Units

Term hours: 36 lecture and 54 laboratory. This course introduces students to both Microsoft client and server sides for the administration and management of Windows networking on personal computers. Students will learn the features and architectures of the various types of client/server implementations such as program installation, working with files and folders, printing system, configuring users and groups, active directory, DNS, and group policy. Pass/No Pass/Letter Grade Option. \$3.00 Material Fee-Payable at Registration. (CSU)

CIS 187 C Microsoft Exchange and SharePoint Services 3 Units

Term hours: 36 lecture and 54 laboratory. This course introduces students to the administration of Microsoft Exchange Server. Students learn an overview of the Exchange Server environment, installing and administering Exchange Server, user and database management, and operating Exchange Server in a Web-based environment. Emphasis is placed on installing and administering Exchange Server, setting up user accounts and user access, and managing resources. Students should be familiar with using Microsoft Windows Server Operating System. In addition, student will learn how to manage and create collaborative Web sites using SharePoint. Pass/No Pass/Letter Grade Option. \$3.00 Material Fee-Payable at Registration. (CSU)

CIS 189 C Administrating and Configuring Windows Server Directory Services 3 Units

Term hours: 36 lecture and 54 laboratory. The course covers implementing, managing, maintaining and configuring directory services and infrastructure in a Windows server environment. This course focuses on active directory domain services (AD DS), group policy, hyper-V, file services, domain name system, setting up user accounts and user access, managing resources and advanced networking services and infrastructure. Pass/No Pass/Letter Grade Option. \$3.00 Material Fee-Payable at Registration. (CSU)

CIS 191 C Administrating and Configuring Windows Server Network Infrastructure 3 Units

Term hours: 36 lecture and 54 laboratory. This course primarily covers the administration and configuration tasks required to deploy, manage and maintain Windows server infrastructure and necessary network services. Emphasis is placed on advanced network and file services, dynamic access control, distributed active directory domain, active directory certificate, rights management, network load balancing, virtual machine manager, failover clustering, and IP address management. Pass/No Pass/Letter Grade Option. \$3.00 Material Fee-Payable at Registration. (CSU)

CIS 194 C Internet Security (ISA) Server 3 Units

Term hours: 54 lecture and 18 laboratory. This course prepares students to install and configure the Microsoft Internet Security and Acceleration Server (ISA) Enterprise Edition. Students will gain knowledge of how to use the Microsoft ISA server as both a firewall and Web-caching server. Topics include installing the ISA server; configuring and troubleshooting the ISA server services; configuring, managing, and troubleshooting policies and rules; deploying, configuring, and troubleshooting the client computer; and monitoring, managing, and analyzing the ISA server use. Pass/No Pass/Letter Grade Option. \$3.00 Material Fee-Payable at Registration. (CSU)

CIS 195 C Network Security 3 Units

Term hours: 54 lecture and 18 laboratory. This course prepares students to identify network security threats and implement procedures for securing networks. Important network security topics covered in CompTIA's Security+ and CSSP (System Security Certified Practitioner) certificates such as access control, identity management, cryptography, policies, physical security and assessments & audits are included. Pass/No Pass/Letter Grade Option. \$3.00 Material Fee-Payable at Registration. (CSU)

CIS 196 C Anti-Hacking Network Security 3 Units

Term hours: 54 lecture and 18 laboratory. This course provides students with basic anti-hacking network security concepts and hands-on skills. Important network security topics covered in CompTIA's Security+ and CSSP certificates such as perimeter, network, host, application and data defenses are covered. Pass/No Pass/Letter Grade Option. \$3.00 Material Fee-Payable at Registration. (CSU)

CIS 201 C Microsoft Virtualization and Cloud Deployment 3 Units

Term hours: 54 lecture and 18 laboratory. This course prepares students to plan, implement, and manage Microsoft virtual enterprise infrastructure. Topics include Hyper-V, System Center Services, Desktop Virtualization, and Cloud Computing. Pass/No Pass/Letter Grade Option. \$3.00 Material Fee - Payable at Registration. (CSU)

CIS 202 C VMware vSphere Virtualization**Networking****3 Units**

Term hours: 54 lecture and 18 laboratory. In this hands-on training course students will install, configure, manage, and troubleshoot VMware vSphere, which includes VMware ESXi and VMware vCenter Server. Students are taught how to administer a vSphere infrastructure for an organization of any size. In doing so, students explore fundamentals of virtual network design and implementation, fundamentals of storage area networks, virtual switching, virtual system management, and engineering for high availability. It is recommended ONLY for students with strong knowledge in networking. Pass/No Pass/Letter Grade Option. \$3.00 Material Fee - Payable at Registration. (CSU)

CIS 211 C Introduction to Programming**3 Units**

Term hours: 54 lecture and 18 laboratory. This beginning course in programming introduces students to the Visual C# .NET and Visual Basic .NET programming languages. Students will learn how to design, code, and debug programs common to the business environment. Some of the topics include: Program Design, Control Structures, Functions, Sub Procedures, Form Design, and Object-Oriented coding. \$3.00 Material Fee - Payable at Registration. (UC/CSU)

CIS 216 C Microsoft Project**3 Units**

Term hours: 54 lecture and 18 laboratory. This course uses Microsoft Project to create a task list, set up and assign resources, format and print plan, track progress, share project information, and manage project team. Students will learn how to solve typical project and business problems using the planning, control and reporting features of Microsoft Project. \$3.00 Material Fee-Payable at Registration. (CSU)

CIS 217 C Visual Basic Programming**3 Units***Prerequisite: CIS 211 C.*

Term hours: 54 lecture and 18 laboratory. This course introduces students to the Visual Basic programming language. Students will learn how to design, code, and debug programs common to the business environment. Some of the topics include: Form Design, Sub Procedures, Functions, Object-Oriented Programming, Arrays, and Accessing DataBase Files. \$3.00 Material Fee - Payable at Registration. (UC/CSU)

CIS 218 C Visual C# Programming**3 Units***Prerequisite: CIS 211 C.*

Term hours: 54 lecture and 18 laboratory. This course introduces students to the Visual C# programming language. Students will learn how to design, code, and debug programs common to the business environment. Some of the topics include: Classes and Objects, Methods, Arrays, and Form Development. \$3.00 Material Fee - Payable at Registration. (CSU)

CIS 219 C Advanced Visual Basic**3 Units***Prerequisite: CIS 217 C Visual Basic Programming.*

Term hours: 54 lecture and 18 laboratory. This is an advanced course in Visual Basic programming. Special emphasis will be placed on the application of the Visual Basic language to solve business problems, including requirements definition, design, construction, testing, and documenting. Multiple forms, objects, controls, Object Linking and Embedding (OLE), and the use of the data control object to interface with databases external to Visual Basic .NET will be covered. \$3.00 Material Fee - Payable at Registration. (CSU)

CIS 220 C Web Page Programming**3 Units***Advisory: CIS 179 C or consent of the instructor.*

Term hours: 54 lecture and 18 laboratory. Students will learn how to create Web pages that include Cascading Style Sheets (CSS), how to create JavaScript programs inside HTML (Hyper Text Markup Language) documents, how to use JavaScript programs to enhance Web pages, and how to use elements of Dynamic HTML. Emphasis is placed on multiple page layers, scripting, and managing large-scale Web sites. Using these tools and techniques, students will learn to create dynamic effects based on users interaction, simple animation, drop-down menu, and other sophisticated and useful design effects. Pass/No Pass/Letter Grade Option. \$3.00 Material Fee-Payable at Registration. (CSU)

CIS 221 C Web Technology and Social Media**3 Units**

Term hours: 54 lecture and 18 laboratory. This course introduces students to the new concept in Web technology called Collaborative Internet. The term refers to the use of the Internet technology to enhance information sharing, interactive and collaborative Web sites, social networking, publishing and posting information on the Web, and active participation among Web users. Emphasis is placed on the various applications of this emerging Web technology such as Podcasts, Blogs, Wikis, Mashups, RSS (Really Simple Syndication) Feeds, Flickr, collaborative favorites, and social networks in both theoretical and practical frameworks. Pass/No Pass/Letter Grade Option. \$3.00 Material Fee - Payable at Registration. (CSU)

CIS 223 C Visual C++ Programming**3 Units***Prerequisite: CIS 211 C.*

Term hours: 54 lecture and 18 laboratory. This course introduces students to the Visual C++ programming language. Students will learn how to design, code, and debug programs common to the business environment. Some of the topics include: Control Structures, Functions, Classes and Objects, Arrays, and File Processing. \$3.00 Material Fee - Payable at Registration. (UC/CSU)

CIS 225 C Web Programming with ASP**3 Units**

Term hours: 54 lecture and 18 laboratory. This course prepares students to use ASP (Active Server Pages) as a web programming language to create dynamic, interactive, and data-driven web applications. Students will learn how to develop web applications that interact with viewers as well as with other computer applications. Emphasis is placed on reading and writing data to a file on the web server, developing interactive web pages, creating web applications that integrate data bases, server-side programming, optimizing the performance of web applications, developing user controls, working with ASP web services, debugging web applications, creating mobile web applications. Pass/No Pass/Letter Grade Option. \$3.00 Material Fee-Payable at Registration. (CSU)

CIS 226 C Java Programming**3 Units***Prerequisite: CIS 211 C.*

Term hours: 54 lecture and 18 laboratory. This course introduces students to the Java programming language. Students will learn the language syntax, how to design and debug programs, and how to use Java programs with HTML pages. \$3.00 Material Fee-Payable at Registration. (UC/CSU)

CIS 227 C Java Script Programming and AJAX**3 Units***Advisory: CIS 179 C or Consent of Instructor.*

Term hours: 54 lecture and 18 laboratory. This course teaches the students to use the JavaScript programming languages to enhance Web pages. Emphasis is placed on creating HTML pages that include JavaScript programs. The student will learn the basic syntax of the JavaScript language, how to create JavaScript programs inside HTML documents, and how to use JavaScript programs to enhance Web pages. In addition, the application of AJAX Web programming language will be discussed. Pass/No Pass/Letter Grade Option. \$3.00 Material Fee-Payable at Registration. (CSU)

CIS 229 C Introduction to XML Programming 3 Units*Advisory: CIS 220 C.*

Term hours: 54 lecture and 18 laboratory. This is a class in Web documents management. The course is ideal for students interested in next-generation Web publishing who want to gain a working knowledge of XML (Extensible Mark-up Language) and use it to build a wide range of dynamic effects and compelling Web applications from formatting and managing documents to E-commerce and searching and managing data. In this class, students will master the fundamentals of XML, including XSL (Extensible Stylesheet Language), DTDs (Document Type Definitions), CSS (Cascading Style Sheets) and XML schemas. This course is designed for those with experience in creating Web pages and who have some knowledge of style sheets. Pass/No Pass/Letter Grade Option. \$3.00 Material Fee-Payable at Registration. (CSU)

CIS 230 C Cisco Networking 1 3 Units

Term hours: 36 lecture and 54 laboratory. This course focuses on network terminology and protocols, Local Area Networks (LANs), Wide Area Networks (WANs), Open System Interconnection (OSI) model, cabling, cabling tools, routers, router programming, Ethernet, Internet Protocol (IP) addressing, and network standards. This course is offered through Cisco Local Academy and upon successful course completion students will receive a certificate from Cisco. Pass/No Pass/Letter Grade Option. \$3.00 Material Fee-Payable at Registration. (CSU)

CIS 231 C Cisco Networking 2 3 Units*Prerequisite: CIS 230 C.*

Term hours: 36 lecture and 54 laboratory. This course introduces students to router fundamentals, router setup and configuration, network management, routing and routed protocols, and network troubleshooting. Topics include: managing Cisco IOS software, Distance Vector Routing Protocols, TCP/IP suite error and control messages, basic router troubleshooting, and access control lists. This course is offered through Cisco Local Academy and upon successful course completion students will receive a certificate from Cisco. Pass/No Pass/Letter Grade Option. \$3.00 Material Fee-Payable at Registration. (CSU)

CIS 232 C Cisco Networking 3 3 Units*Prerequisite: CIS 231 C.*

Term hours: 36 lecture and 54 laboratory. This course focuses on advanced IP addressing techniques; Variable Length Subnet Masking (VLSM), intermediate routing protocols (RIP v2, single-area OSPF, EIGRP), command-line interface configuration of switches, Ethernet switching, Virtual LANs (VLANs), Spanning Tree Protocol (STP) and VLAN Trunking Protocol (VTP). This course is offered through Cisco Local Academy and upon successful course completion students will receive a certificate from Cisco. Pass/No Pass/Letter Grade Option. \$3.00 Material Fee-Payable at Registration. (CSU)

CIS 233 C Cisco Networking 4 3 Units*Prerequisite: CIS 232 C.*

Term hours: 36 lecture and 54 laboratory. This course focuses on advanced IP addressing techniques; Network Address Translation (NAT), Port Address Translation (PAT), and DHCP; WAN technology and terminology; PPP, ISDN, DDR, Frame Relay, network management, and introduction to optical networking. This course is offered through Cisco Local Academy and upon successful course completion students will receive a certificate from Cisco. Pass/No Pass/Letter Grade Option. \$3.00 Material Fee-Payable at Registration. (CSU)

CIS 234 C Advanced Java Programming 3 Units*Prerequisite: CIS 226 C.*

Term hours: 54 lecture and 18 laboratory. This course covers advanced topics in Java programming. Topics include graphics, animation, GUI components, exception handling, files and streams, and data structures. \$3.00 Material Fee-Payable at Registration. (UC/CSU)

CIS 236 C Introduction to Oracle: SQL and PL/SQL 3 Units

Term hours: 36 lecture and 54 laboratory. This course offers students an extensive introduction to data server technology. The class covers the concepts of both relational and object relational databases and the powerful SQL (Structured Query Language). Students are taught to create and maintain database objects and to store, retrieve, and manipulate data. In addition, students learn to create PL/SQL blocks of application code that can be shared by multiple forms, reports, and data management applications. Demonstrations and hands-on practice reinforce the fundamental concepts. \$3.00 Material Fee-Payable at Registration. (CSU)

CIS 239 C CCNA Bootcamp 3 Units*Advisory: CIS 230 C.*

Term hours: 54 lecture and 18 laboratory. CCNA concepts and configuration skills will be reviewed to prepare for the exam. Topics include IP addressing and subnetting, router and switch configurations, LAN and WAN protocols, and sample exam questions. \$3.00 Materials Fee-Payable at Registration. (CSU)

CIS 240 C Wireless Networking Technology 3 Units*Advisory: CIS 230 C.*

Term hours: 54 lecture and 18 laboratory. This course focuses on wireless data communication technologies with an emphasis on Wireless networks. A comprehensive overview of wireless technologies, devices, security, design, and best practices with a particular emphasis on real world applications and skills is covered. Pass/No Pass/Letter Grade Option. \$3.00 Material Fee-Payable at Registration. (CSU)

CIS 241 C Spreadsheet-Advanced MS Excel 3 Units*Prerequisite: CIS 132 C.*

Term hours: 54 lecture and 18 laboratory. This course is designed to introduce students to the use of advanced spreadsheet tools in the solution of problems. Students will use Visual Basic to develop Excel applications. \$3.00 Material Fee - Payable at Registration. (CSU)

CIS 242 C Database-Advanced MS Access 3 Units*Prerequisite: CIS 142 C.*

Term hours: 54 lecture and 18 laboratory. This course teaches advanced topics in Microsoft Access. Students will learn how to design and implement complex databases; how to use Structured Query Language; and how to create complex queries, complex forms, and complex reports. Other topics include how to write Microsoft Access programs using Visual Basic and how to use Access with other applications. \$3.00 Material Fee-Payable at Registration. (CSU)

CIS 244 C Java Game Programming 3 Units

Term hours: 54 lecture and 18 laboratory. This course covers game programming for Java developers. It leads students to create desktop and Internet computer games using the latest Java programming language techniques. \$3.00 Material Fee-Payable at Registration. (CSU)

CIS 245 C Perl Programming 3 Units

Term hours: 54 lecture and 18 laboratory. This hands-on course introduces students to the Perl and CGI programming language. Topics include syntax, basic scripting skills, arrays and hashes, I/O, regular expressions, and subroutines. The course also introduces object-oriented programming in Perl, as well as CGI.pm module and Perl web programming. Pass/No Pass/Letter Grade Option. \$3.00 Material Fee-Payable at Registration. (CSU)

CIS 246 C PHP Programming 3 Units

Term hours: 54 lecture and 18 laboratory. This hands-on course introduces students to the PHP programming language. Topics include basic PHP programming skills, and integration with HTML. It also explores advanced modules including accessing the MySQL database. Students will learn to develop dynamic web content and data-driven web sites using PHP. Pass/No Pass/Letter Grade Option. \$3.00 Material Fee-Payable at Registration. (CSU)

CIS 247 C Python Programming 3 Units

Term hours: 54 lecture and 18 laboratory. In this class students will obtain a hands-on introduction to the Python language, Python tools, Python applications, and Python Web programming. Through lectures and laboratory work, students learn the skills of Python programming. Pass/No Pass/Letter Grade Option. \$3.00 Material Fee-Payable at Registration. (CSU)

CIS 248 C Voice Over IP 3 Units

Advisory: CIS 230 C and CIS 231 C.

Term hours: 54 lecture and 18 laboratory. This course focuses on the design, configuration, troubleshooting and operation of IP (Internet Protocol) telephony technology to exchange voice. A comprehensive overview of packet telephony technologies including signaling, call control and voice quality with a particular emphasis on real world applications and skills is covered. Pass/No Pass/Letter Grade Option. \$3.00 Material Fee - Payable at Registration. (CSU)

CIS 250 C Word Processing 1 to 2 Units

Term hours: 18-36 lecture and 54-108 laboratory TBA. This variable unit, open entry/open exit course with flexible hours consists of basic and advanced text editing performed using Microsoft Word. Unit credit may range from 1 to 2 units in any given semester. Units may be increased or decreased no later than the withdrawal deadline of the course. Only upon successful completion of the first unit of instruction will the student be eligible for the second unit of credit for the semester. Knowledge of keyboarding is recommended. Open Entry/Open Exit. Pass/No Pass/Letter Grade Option. \$3.00 Material Fee-Payable at Registration. (CSU)

CIS 251 C Advanced Word Processing 1 to 2 Units

Prerequisite: CIS 250 C.

Term hours: 18-36 lecture and 54-108 laboratory TBA. This variable unit, open entry/open exit course with flexible hours is designed as a continuation of CIS 250 C. Advanced applications include, but are not limited to, desktop publishing, macros, margins, and record processing. Unit credit may range from 1 to 2 units in any given semester. Units may be increased or decreased no later than the withdrawal deadline of the course. Only upon successful completion of the first unit of instruction will the student be eligible for the second unit of credit for the semester. May be taken for a cumulative total of 2 units. Open Entry/Open Exit. Pass/No Pass/Letter Grade Option. \$3.00 Material Fee-Payable at Registration. (CSU)

CIS 252 C Java Web and Mobile Applications 3 Units

Prerequisite: CIS 226 C.

Term hours: 54 laboratory and 18 laboratory. This course covers topics in Java Web and Mobile Applications. Topics include multithreading, networking, JDBC, Servlet, JSF, web services and mobile applications. \$3.00 Material Fee-Payable at Registration. (CSU)

CIS 253 C Oracle PL/SQL Programming 3 Units

Term hours: 54 lecture and 18 laboratory. This course introduces students to the essential concepts and techniques needed to build web application on Oracle Application Server. Students will learn to create PL/SQL applications that access Oracle database but deliver outputs in HTML format. \$3.00 Material Fee - Payable at Registration. (CSU)

CIS 254 C Mobile Application Development 3 Units

Term hours: 54 lecture and 18 laboratory. Students will learn how to develop applications for use on small and mobile devices. The Android platform will be used for the basis of this course. Additional platforms may be introduced for comparison purposes. Students will create applications for the Android platform using the various specialized development environments available. \$3.00 Materials Fee - Payable at Registration. (CSU)

CIS 257 C Storage Management and Cloud Computing 3 Units

Advisory: CIS 230 C.

Term hours: 54 lecture and 18 laboratory. This course covers concepts, principles, and deployment considerations across all technologies that are used for storing, managing, and protecting digital information in classic, virtualized, and cloud environments. Students will also be introduced to Cloud Computing. Course is supplemented with the EMC Academic Alliance Curriculum and 24/7 access to NetLab. Pass/No Pass/Letter Grade Option \$3.00 Materials Fee-Payable at Registration. (CSU)

CIS 258 C CCNA Security 3 Units

Advisory: CIS 230 C and CIS 231 C.

Term hours: 36 lecture and 54 laboratory. CCNA Security equips students with the knowledge and skills needed to prepare for entry-level security specialist careers. Topics covered include: implementing AAA on network devices, implementing Cisco IOS firewall and IPS feature sets, implementing site-to-site IPsec VPNs, and administering effective security policies. This course is offered through Cisco Local Academy and upon successful course completion students will receive a certificate from Cisco. Pass/No Pass/Letter Grade Option. \$3.00 Material Fee-Payable at Registration. (CSU)

CIS 260 C Game Concepts Development 3 Units

Term hours: 36 lecture and 54 laboratory. In this course students will study the technology, structure, hardware, software, graphics and art, sound effects, simulation engines, and job market trends involved in the construction of computer games. Students will learn how to plan and develop outlines for their own games. The course will emphasize hands-on exercises in creation of games using game generator software. Pass/No Pass/Letter Grade Option. \$3.00 Material Fee - Payable at Registration. (UC/CSU)

CIS 261 C Game Programming 3 Units

Term hours: 54 lecture and 18 laboratory. This course introduces students to basic game programming concepts and program design process. Topics include game terminology, genre analysis, platform comparisons, and content creation. Students will also explore major game programming languages. Pass/No Pass/Letter Grade Option. \$3.00 Materials Fee - Payable at Registration. (CSU)

CIS 262 C New Technology 3 Units

Term hours: 54 lecture and 18 laboratory. This hands-on class is designed to teach students to acquire the necessary technical skills in the use of the latest technology. Emphasis is placed on the current and future trends of information technology in today's computer industry. Pass/No Pass/Letter Grade Option. \$3.00 Material Fee-Payable at Registration. (CSU)

CIS 263 C Mobile Game Programming 3 Units

Term hours: 54 lecture and 18 laboratory. This course offers an overview of the gaming products for platforms involving anything handheld, including cell phones, PDAs and Pocket PCs. Students will learn to develop mobile games for the portable platforms of their choices. Pass/No Pass/Letter Grade Option. \$3.00 Materials Fee-Payable at Registration. (CSU)

CIS 264 C Windows Game Programming 3 Units

Term hours: 54 lecture and 18 laboratory. This course leads students to develop skills and techniques relevant to the programming of computer games for Windows. The course will focus primarily on programming aspects. Pass/No Pass/Letter Grade Option. \$3.00 Material Fee - Payable at Registration. (CSU)

CIS 265 C 3D Game Programming 3 Units

Term hours: 54 lecture and 18 laboratory. This course uses open source tools to introduce programming skills and techniques for creating interactive 3D games. The course will focus primarily on programming aspects. Pass/No Pass/Letter Grade Option. \$3.00 Material Fee - Payable at Registration. (CSU)

CIS 271 C Computer Forensics in Practice 1 Unit

Term hours: 18 lecture. This course provides a comparative study of information technology, evidence analysis, chain of custody, and data retrieval from computer hardware and software applications. \$3.00 Material Fee - Payable at Registration. (CSU)

CIS 272 C Computer Forensics New Challenge 1 Unit

Term hours: 18 lecture. This course introduces new technologies of computer forensics and emerging investigation techniques related to the identification, collection and preservation of digital evidence. \$3.00 Material Fee - Payable at Registration. (CSU)

CIS 273 C Computer Forensics Tools 1 Unit

Term hours: 18 lecture. This hands-on course teaches students to build toolkits for finding, identifying, and preserving digital evidence for computer forensic process. \$3.00 Material Fee - Payable at Registration. (CSU)

CIS 274 C Project Management Fundamentals 3 Units

Term hours: 54 laboratory and 18 laboratory. This course teaches the basics of project management and includes preparation for the Project Management Professional certification exam. Topics include integration, scope, time, cost, quality, human resource management, communications, risk, and procurement management. Pass/No Pass/Letter Grade Option. \$3.00 Materials Fee-Payable at Registration. (CSU)

CIS 276 C Computer Forensics I 3 Units

Term hours: 54 lecture and 18 laboratory. This course introduces basic techniques and methods used for collecting and preserving digital evidences for computer forensic process. This course emphasizes on gathering digital evidences from a computer system. Pass/No Pass/Letter Grade Option. \$3.00 Material Fee - Payable at Registration. (CSU)

CIS 277 C Computer Forensics II 3 Units

Term hours: 54 lecture and 18 laboratory. This course equips students with professional knowledge and techniques to investigate, preserve, process, report, and present digital evidence. \$3.00 Material Fee-Payable at Registration. (CSU)

CIS 278 C Cyber Crime 3 Units

Term hours: 54 lecture and 18 laboratory. This course will introduce the student to concepts and actions involved with cybercrime. The emphasis of the course will be placed on the student gaining an understanding of the types, the elements, and the corresponding forensic evidence that exists from cybercrime. \$3.00 Material Fee - Payable at Registration. (CSU)

CIS 279 C Computer Forensics Legal Aspects 3 Units

Term hours: 54 lecture and 18 laboratory. This course will examine the civil and criminal aspects of computer forensics. Students will be introduced to case law and will learn appropriate steps, procedures, and techniques to comply with law when conducting forensic examinations. Also, testimony concepts by the forensic examiner will be discussed. Pass/No Pass/Letter Grade Option. \$3.00 Material Fee - Payable at Registration. (CSU)

CIS 280 C Analysis of Digital Media 3 Units

Term hours: 54 lecture and 18 laboratory. This course will provide the student with the concepts and skills to complete examinations on alternative digital media. This includes an understanding of the various file systems, acquisition procedures, recovery methods, and reporting on findings. \$3.00 Material Fee - Payable at Registration. (CSU)

CIS 281 C Computer Forensics Capstone 3 Units

Prerequisite: CIS 280 C with a minimum grade of "C".

Term hours: 54 lecture and 18 laboratory. This course will complete the computer forensics certificate program with a thorough testing process of the student's knowledge of computer forensics. Through a series of examinations, students will demonstrate their knowledge of appropriate computer forensic procedures/protocol, acquisition techniques, file systems, analysis of files, alternative media, Internet history/email analysis, log analysis, reporting, incorporating all knowledge gained through the courses. \$3.00 Material Fee - Payable at Registration. (CSU)

CIS 295 C CIS Internship 1 to 4 Units

Term hours: 18 lecture and 54-240 laboratory depending on units attempted. This course is designed to give the student credit for work experience at a related occupational worksite, while being concurrently enrolled in a vocational major. For each unit of credit, a minimum of 75 paid or 60 unpaid worksite internship hours is required. The internship allows students to apply knowledge gained in college courses to an actual work setting, sample career choices and improve job-readiness skills. Supplemental reading and course assignments required. Variable Unit Class. May be taken for credit 4 times. Open Entry/Open Exit. Pass/No Pass/Letter Grade Option. (CSU)

CIS 298 C Computer Information Systems Seminar .5 to 12 Units

Prerequisite: May be required.

Corequisite: May be required.

Advisory: May be required.

Term hours: 0-216 lecture and 0-648 laboratory. This course will utilize a lecture and/or lab approach for students enrolled in the Computer Information Systems Program to increase their knowledge in applied areas. Topics will be offered to increase the student's knowledge of the computer information systems profession by updating content on recent changes and requirements and by preparing for new trends in Computer Information Systems. May be taken for credit 1-4 times. Pass/No Pass or Pass/No Pass/Letter Grade Option or Standard Letter Grade. Fee may be required-Payable at Registration. (CSU)

CIS 299 C CIS Independent Study .5 to 2 Units

Prerequisite: Approved Independent Study Learning Contract.

Term hours: 9-36 hours lecture depending on units attempted. This course is designed for students who wish to gain further experience, knowledge, or expertise beyond their current offerings in their area of study. The number of class hours or activities per week will be determined by the scope of the topic. The instructor will devise learning strategies to be followed by the student. Students must obtain permission from the program coordinator to be enrolled in this class. Pass/No Pass/Letter Grade Option. May be taken for credit 4 times. (CSU)

Computer Science

Division of Science/Engineering/Mathematics

Division Dean — Richard Fee

Counselor
Deidre Porter

COMPUTER SCIENCE TRANSFER PROGRAM

Students should consult a counselor or www.assist.org for lower division major requirements for most California public universities. (See the Standard Definitions section of the catalog for a description of ASSIST.) Students transferring to an independent college/university should consult the catalog of the individual school and a counselor for lower division major requirements.

Computer Science (CSCI)

CSCI 123 C Introduction to Programming Concepts in C++

4 Units

Prerequisite: MATH 141 C or MATH 142 C with minimum grades of "C".

Term hours: 72 lecture and 18 laboratory. This course is an introduction to the basic principles of programming using C++ as the development tool. Topics include the structure and design of algorithms, input/output, branching structures, functions, recursion, built-in data types, arrays, structures, files, pointers and elementary operations on linked structures. The object-oriented programming paradigm will be introduced. Topics include encapsulation, polymorphism, libraries, streams, inheritance and abstract data types. Students will design algorithms, write external and internal documentation and design and write source code in C++. (UC/CSU)

CSCI 133 C Data Structures in C++

4 Units

Prerequisite: CSCI 123 C with a grade of "C" or better.

Term hours: 72 lecture and 18 laboratory. This is a course in algorithm design and data structures implemented using C++. Data structures examined are arrays, linked lists, stacks, queues, trees, tables, and graphs. Algorithm topics include hashing, sorting heaps, searches and algorithm efficiency using Big-O notation. Students will create and modify class libraries to implement these structures. (UC/CSU)

Continuing Education Program

The Division of Health Science offers courses through extended day sessions at Cypress College and through the Adult Continuing Education Department of the North Orange County Community College District. Continuing education courses are designed for programs within the Health Science Division.

General inquiries and application to programs may be obtained from the Health Science Counseling Office at (714) 484-7270. The classes offered are approved by the California Board of Registered Nursing (Provider Number 00110), for the number of hours the class meets. Request list of approved classes from the Health Science Division.

Counseling and Student Development

Division of Counseling

Division Dean — Paul R. de Dios

Director, DSS — Celeste Phelps

Manager, International Student Program — Yongmi Han

Manager, Student Success and Support Program — vacant

Articulation Officer — Jacqueline Rangel

Faculty — Counselors

| | |
|------------------------|--|
| Dana Bedard | dbedard@CypressCollege.edu |
| Kelly Carter | kcarter@CypressCollege.edu |
| Sarah Coburn | scoburn@CypressCollege.edu |
| Yolanda Duenas | yduenas@CypressCollege.edu |
| Penny Gabourie | pgabourie@CypressCollege.edu |
| Robert Grantham | rgrantham@CypressCollege.edu |
| Ernesto Heredia | eheredia@CypressCollege.edu |
| Jane Jepson | jjepson@CypressCollege.edu |
| Renay Laguana-Ferinac | rlaguana@CypressCollege.edu |
| Marissa Lehmeier | mlehmeier@CypressCollege.edu |
| Deborah Michelle | dmichelle@CypressCollege.edu |
| Therese Mosqueda-Ponce | tmponce@CypressCollege.edu |
| Daniel Pelletier | dpelletier@CypressCollege.edu |
| Deidre Porter | dporter@CypressCollege.edu |
| Renee Ssensalo | rssensalo@CypressCollege.edu |
| Denise Vo | dvo@CypressCollege.edu |

During the summer months, counselors can be reached by email at onlinecounselor@CypressCollege.edu.

PROGRAM LEARNING OUTCOMES (PLOs)

The courses taught by this department contribute to the General Education and Basic Skills Program Learning Outcomes. Please refer to General Education and Basic Skills Program Learning Outcomes.

Counseling and Student Development (COUN)

COUN 040 C College Readiness

.5 Units

Term hours: 8-9 lecture. This course is designed to prepare students for their first college semester by satisfying the California community colleges' matriculation requirements of assessment, orientation, and counseling/advising. Non Degree Credit. Pass/No Pass only.

COUN 060 C Academic Success/College Survival

1 Unit

Term hours: 9 lecture. This course is designed to help students who are experiencing difficulties in succeeding in college. Students will learn skills such as time management, decision-making, and study skills which will enable them to identify and overcome educational difficulties. Pass/No Pass only.

COUN 073 C Computer Access I

3 Units

Term hours: 36 lecture and 54 laboratory. This course is designed for students with verified disabilities. This course provides training in the use of assistive technology which enhances the ability of students with disabilities to access and use personal computers. The course will cover word processing and an introduction to the Internet. May be taken for credit 2 times. Pass/No Pass/Letter Grade Option.

COUN 100 C College Orientation 1 Unit

Advisory: This course is designed for students who are eligible for services from Disability Support Services (DSS).

Term hours: 18 lecture. This course will introduce students to campus support services, establish realistic goals, develop study skills, and discuss time management strategies. Students will learn about accessing accommodations on campus and in the community. Pass/No Pass (CSU)

COUN 105 C Stress and Anxiety Management 3 Units

Term hours: 54 lecture. This course is designed to increase the student's awareness of the effects of stress and anxiety on academic performance and daily life. Emphasis will be placed on understanding effective and ineffective responses to stress and anxiety and on planning a personal stress and anxiety and management program. Students will explore and practice a variety of practical coping skills and management techniques. Pass/No Pass/Letter Grade Option. (CSU, CSU GE)

COUN 110 C Teaching as a Career 3 Units

Term hours: 36 lecture and 54 laboratory TBA. This course is designed as an introduction to the teaching profession where students will examine concepts and issues related to education in a democratic society within historical, social, philosophical, legal and political contexts. Students will develop personal knowledge and understanding of (1) the competing purpose and values of schools in society, (2) the nature of teaching and the teaching profession, (3) the impact of local, state, and federal government policies on schools, and (4) contemporary educational issues. Course content and assignments will be related to a 45 hour fieldwork experience in an educational setting. Pass/No Pass/Letter Grade Option. (UC/CSU)

COUN 135 C Leadership 3 Units

Term hours: 54 lecture. This course includes the study and practical application of group and individual leadership techniques. It is designed to improve awareness of group dynamics, listening skills, personal values, decision-making, problem solving and organizational development. Duplicate credit not granted for COUN 135HC. (UC/CSU)

COUN 135HC Honors Leadership 3 Units

Term hours: 54 lecture. This is an enhanced leadership development course that requires leadership participation in a campus or community organization. It includes the study and practical application of group and individual leadership techniques. It is designed to improve awareness of group dynamics, listening skills, personal values, decision-making, problem solving and organizational development. It emphasizes critical analysis of leaders in the news, history or literature. Duplicate credit not granted for COUN 135 C. (UC/CSU)

COUN 140 C Educational Planning 1 Unit

Term hours: 18 lecture. This course is designed for new students as part of the Student Success and Support Program. The course includes: an orientation to college life, responsibilities, requirements, and regulations; an overview of the assessment process; certificates, occupational degrees, and transfer degrees; the transfer process; career guidance for selection of a major plan of study; college success factors; and development of a student educational plan (SEP). Pass/No Pass. \$10.00 Materials Fee - Payable at Registration. (UC/CSU)

COUN 141 C Career Exploration 1 Unit

Term hours: 18 lecture. This class is designed for students who are undecided about their educational or career goals. Using a career planning process, students assess interests, skills, personality, values, life and work style choices. Students explore cultural differences and gain an awareness which is applied to the work setting. Students research potential educational and career goals; apply decision making tools, and relate their self-assessment information to occupational possibilities and college majors. Pass/No Pass only. \$6.00 Material Fee-Payable at Registration. (CSU, CSU GE)

COUN 144 C Women and Careers 2 Units

Term hours: 36 lecture. This course is designed to help women expand their self-image by providing personal exploration through career assessment, values clarification and skills analysis. The course provides creative job search techniques and resume writing, interviewing skills, decision-making, goal setting, and a portfolio. Pass/No Pass only. \$6.00 Material Fee-Payable at Registration. (CSU, CSU GE)

COUN 145 C Job Readiness and Career Management 2 Units

Term hours: 36 lecture. Students will learn to successfully bridge from college to the workplace (or make a job transition). In a future of constant change, students will learn how to maximize their strengths, skills, and college learning for gainful and satisfying employment. Students will create a personal brand and professional in-person and online presence to optimize their career opportunities. Resumes, interviewing, business etiquette, job search, networking, and long term career management issues are discussed, developed and/or practiced. (CSU, CSU GE)

COUN 146 C Decision Making 1 Unit

Term hours: 18 lecture. This course is designed to teach students decision-making concepts and skills for application in career planning, educational planning, and everyday life. Emphasis will be placed on practicing decision-making through class discussions, role-playing, and simulation. Pass/No Pass/Letter Grade Option. (CSU, CSU GE)

COUN 147 C Peer Advising 1 Unit

Term hours: 18 lecture. This course is designed to provide skills in specific peer advisement situations, observations, and communications. Training in active listening, group processes, and role-playing are emphasized. Pass/No Pass only. (CSU)

COUN 150 C Academic and Life Success 3 Units

Term hours: 54 lecture. This course will provide students with knowledge, information, and practical skills to better understand themselves as students, people and members of society. It will assist them in achieving academic, and life goals and to develop plans and strategies to successfully meet those goals. (CSU, CSU GE)

COUN 151 C Career and Life Planning 3 Units

Term hours: 54 lecture. A complete class in career/life planning, including introduction to the tools for dealing with change; an analysis of desired lifestyles; self-assessment; overcoming obstacles, and analysis of work, its organizations, and where you want to work; decision-making, people, environments, career-researching and job-finding, resumes, interviewing, and goal setting. \$3.00 Material Fee-Payable at Registration. Pass/No Pass/Letter Grade Option. (CSU, CSU GE)

COUN 156 C Self-Concept 1 Unit

Term hours: 18 lecture. This course introduces the student to the self-concept and assists students in acquiring the psychological characteristics necessary to meet daily challenges. Emphasis is on the enhancement of academic performance and success as a result of developing a stronger self-concept. Pass/No Pass/Letter Grade Option. (CSU)

COUN 160 C College/University Transition 1 Unit

Term hours: 18 lecture. This course is designed for the student and the parents of the student who plans to transfer to a college or university. Topics include the value of pursuing higher education, selection of a transfer institution, admissions, academic requirements, financial aid options, special programs, priority filing deadline, and developing an autobiographical essay. Duplicate Credit Not Granted For COUN 160HC. Pass/No Pass/Letter Grade Option. (CSU)

COUN 160HC Honors University Transition 1 Unit

Term hours: 18 lecture. This course is designed for the Honor Program student. It is an enhanced orientation to the transfer process. Topics include the value of pursuing higher education, selection of a transfer institution, admission, academic requirements, financial aid options, priority filing deadlines, developing an autobiographical essay and personal transfer portfolio. Emphasis will be placed on researching and evaluating transfer options. Duplicate credit not granted for COUN 160 C. Pass/No Pass/Letter Grade Option. (CSU)

COUN 298 C Counseling and Guidance Seminar .5 to 12 Units

Prerequisite: May be required.

Corequisite: May be required.

Advisory: May be required.

Term hours: 0-216 lecture and/or 0-648 laboratory depending on units attempted. Various classes may be offered which are designed to meet the interests and needs of the students and faculty. May be taken for credit 1-4 times. Pass/No Pass or Pass/No Pass/Letter Grade Option or Standard Letter Grade. Fees may be required-Payable at Registration. (CSU)

COUN 299 C Counseling - Independent Study .5 to 2 Units

Prerequisite: Approved Independent Study Learning Contract.

Term hours: Hours vary according to units assigned. This course is designed for students who wish to explore in-depth various guidance-related topics. Students develop an Independent Study Learning Contract with the instructor that details the objectives and course content and scope to be completed by the student. Consult class schedule to verify credit for a particular term. May be taken for credit 4 times. Open Entry/Open Exit. Pass/No Pass only. (CSU)

Court Reporting

Division of Business and Computer Information Systems

Division Dean — Henry Hua

Faculty

Carolee Freer

Counselor

Robert Grantham

PROGRAM LEARNING OUTCOMES (PLOs)

Court Reporting

On completion of the Court Reporting field of study:

1. Students will be able to transcribe documents at a professional level.
2. Students will have the ability to apply the rules of grammar, spelling, punctuation, and capitalization to sentences, paragraphs, testimony, and jury charge through a systematic series of programmed (takes) testing and other projects.
3. Students will be able to demonstrate an understanding and application of California and United States criminal and civil law, along with a basic knowledge of related areas of law and legal terminology.
4. Students will be able to demonstrate an understanding and application of anatomy, physiology, and/or medical terminology.
5. Students will be able to assume the role of the real-time reporter through simulated trials and depositions to perform various functions.

6. Students will be able to produce a complete and accurate transcript of at least ten pages from steno notes, using computer-aided transcription.
7. Students will be able to fulfill the state required internship hours and submit a written narration of their experiences, either in transcript format or in report format. Students will submit a timesheet signed by the supervising reporter in the field verifying hours completed.
8. Students will be able to understand and apply knowledge of basic vocabulary to a variety of reporting situations.
9. Students will be able to understand and follow the California codes as they apply to reporting situations.
10. Students will be able to demonstrate knowledge of court and deposition procedures, along with an understanding of court structure, both state and Federal.
11. Students will be able to prepare an 18,000 word steno dictionary using computer software with applications for the completion of transcripts and other documents.
12. Students will be familiar with the California Court Reporters Code of Ethics and the National Court Reporters Association Code of Ethics and be able to apply these standards, rules, and regulations in the preparation of documents and in reporting situations.

ASSOCIATE IN SCIENCE DEGREE

COURT REPORTING Program Code: 1S07819

The Court Reporting AS degree prepares students for a career in court reporting. The curriculum is designed to develop a working knowledge of the field of deposition reporting and court reporting. The objective of the AS degree in Court Reporting is to provide a skill-based training program through traditional teaching methods with an emphasis on practical and hands-on application of subject matter. A 60-hour internship is required. To earn an Associate Degree students must complete: (1) all major course requirements with a minimum grade of "C"; (2) 25 units of General Education Graduation Requirements; (3) the cultural diversity and reading requirements; (4) any elective courses to complete a minimum of 60 units; and, (5) have a minimum GPA of 2.0. At least 50% of all major course work must be completed at Cypress College. For information on specific university requirements, please consult with your counselor, or visit the Transfer Center.

STUDENTS MUST FURNISH THEIR OWN MACHINE AND PAPER

| Required courses are listed in suggested sequence: | | Units |
|--|---|-------------|
| CTRP 071 C | Legal Terminology and Rhetoric | 3 |
| CTRP 067 C | Basic Vocabulary Development | 2 |
| CTRP 068 C | Advanced Vocabulary Development | 1.5 |
| CTRP 051 C | Court/Conference Reporting: Legal | 3 |
| CTRP 052 C | Court/Conference Reporting: Medical | 3 |
| CTRP 053 C | Court/Conference Reporting: Congressional | 3 |
| CTRP 092 C | Realtime Writing Concepts | 2 |
| CTRP 055 C | Court/Conference Reporting: Jury Charge | 3 |
| CTRP 056 C | Court/Conference Reporting: Jury Charge 2 | 3 |
| CTRP 076 C | Court and Deposition Procedures | 3 |
| CTRP 081 C | Internship - Court Reporting | 3 |
| CTRP 050 C | CSR/RPR Directed Practice | 0.5 |
| CTRP 074 C | CSR-RPR-CBC-CCP Exam Preparation | 1.5 |
| Total Units Required | | 31.5 |

Preparation for State Certificate Examination

The courses listed meet the requirements of the Court Reporter’s Board for an Associate Degree at Cypress College. This program was accredited by the CR Board on March 7, 1978. Academic courses completed in Adult Education or a private Court Reporting School are not transferable.

Courses that fulfill major requirements for an Associate Degree at Cypress College might not be the same as those required for completing the major at a transfer institution offering a Baccalaureate Degree. For information on specific university requirements, please consult with your counselor, or visit the Transfer Center.

STUDENTS MUST FURNISH THEIR OWN MACHINE AND PAPER

Required Courses are listed in suggested sequence:

| Course # | Title | Units |
|------------------------------|--|-------------|
| SEMESTER 1 | | |
| CTRP 040 C | Beginning Machine Shorthand Theory | 3 |
| CTRP 041 C | Court Reporting Theory Review | 3 |
| CTRP 071 C | Legal Terminology and Rhetoric | 3 |
| MGT 055 C | Business English | 3 |
| CTRP 067 C | Basic Vocabulary Development | 2 |
| COUN 140 C | Educational Planning | .5 |
| Total Units Required | | 14.5 |
| SEMESTER 2 | | |
| CTRP 042 C, 043 C | Machine Shorthand Speed Bldg 1 and 2 | 4 |
| CTRP 051 C | Court/Conference Reporting: Legal | 3 |
| CTRP 073AC | Spelling for Modern Business | 1 |
| CTRP 073BC | Punctuation for Court Reporting | 1 |
| HS 145 C | Survey of Medical Terminology | 3 |
| *ENGL 106 C | Critical Thinking | 3 |
| MGT 041 C | Survey of Business Law | 3 |
| | or | |
| MGT 240 C | Legal Environment of Business | (3) |
| | or | |
| MGT 241 C | Legal Aspects-Business Transactions | (3) |
| | or | |
| MGT 141 C | Personal Law | (3) |
| *SOSC | Social Science Elective | 3 |
| Total Units Required | | 21 |
| SUMMER SESSION | | |
| CTRP 044 C, 045 C | Machine Shorthand Speed Building 3 and 4 | 4 |
| Total Units Required | | 4 |
| SEMESTER 3 | | |
| CTRP 057 C | Machine Shorthand Challenge — 160 | 2 |
| CTRP 046 C | Machine Shorthand Speed Building 5 | 2 |
| CTRP 052 C | Court/Conference Reporting: Medical | 3 |
| MGT 242 C | American Judicial System | 4 |
| CTRP 066 C | Machine Transcription — Medical | 2 |
| *Humanities Elective | | 3 |
| *Physical Education Elective | | 1 |
| CTRP 054 C | Two/Four Voice Testimony | 3 |
| CTRP 082 C | Computer Aided Transcription: ProCAT | 1 |
| | or | |
| CTRP 083 C | Computer Aided Transcription: Stenograph | (1) |
| | or | |
| CTRP 084 C | Computer Aided Transcription: Eclipse | (1) |
| Total Units Required | | 21 |

| | | |
|-----------------------------|---|-------------|
| CTRP 047 C | Machine Shorthand Speed Building 6 | 2 |
| CTRP 053 C | Court/Conference Reporting: Congressional | 3 |
| CTRP 055 C, 056 C | Court/Conference Reporting: Jury Charge | 6 |
| CTRP 072 C | Legal Procedures | 4 |
| CTRP 068 C | Advanced Vocabulary Development | 1.5 |
| MGT 143 C | Introduction to Legal Research | 1 |
| CTRP 058 C, 059 C | Machine Shorthand Challenge 180 and 200 | 4 |
| CTRP 085 C | Computer Aided Transcription: Dictionary Building | 1 |
| Total Units Required | | 22.5 |

SUMMER SESSION

| | | |
|-----------------------------|------------------------------------|----------|
| CTRP 048 C | Machine Shorthand Speed Building 7 | 2 |
| CTRP 060 C | Machine Shorthand Challenge — 220 | 2 |
| Total Units Required | | 4 |

SEMESTER 5

| | | |
|-----------------------------|----------------------------------|-------------|
| *POSC 100 C | United States Government | 3 |
| CTRP 076 C | Court and Deposition Procedures | 1.5 |
| CTRP 081 C | Internship: Court Reporting | 2 |
| *BIOL 160 C | Integrated Medical Science | 3 |
| | or | |
| HS 147 C | Survey of Disease | (3) |
| CTRP 074 C | CSR/RPR/CBC/CCP Exam Preparation | 1 |
| CTRP 092 C | Realtime Writing Concepts | 2 |
| Total Units Required | | 12.5 |

PLUS 12–13 Units from the following graduation requirements:

| | | |
|----------------------------|-----|--------------------|
| Written Communication | 3 | |
| Cultural Diversity | 3 | |
| Mathematics | 3–4 | |
| Art | 3 | |
| Program Total Units | | 111.5–112.5 |

*Meets Partial Requirements for Associate Degree

COURT REPORTING CERTIFICATE

Program Code: 1C21103

| Required courses | Units | |
|-----------------------------|--|--------------|
| CTRP 052 C | Court/Conference Reporting: Medical | 3 |
| CTRP 053 C | Court/Conference Reporting: Congressional | 3 |
| CTRP 055 C | Court/Conference Reporting: Jury Charge | 3 |
| CTRP 056 C | Court/Conference Reporting: Jury Charge 2 | 3 |
| CTRP 074 C | CSR-RPR-CBC-CCP Exam Preparation | 1.5 |
| CTRP 076 C | Court and Deposition Procedures | 3 |
| CTRP 050 C | CSR/RPR Directed Practice | 0.5 |
| CTRP 082 C | Computer Aided Transcription: ProCAT | 1 |
| | or | |
| CTRP 083 C | Computer Aided Transcription - Stenograph | (2) |
| | or | |
| CTRP 084 C | Computer Aided Transcription - Eclipse | (2) |
| | or | |
| CTRP 070 C | Computer Aided Transcription: Stenocat | (1) |
| CTRP 085 C | Computer Aided Transcription - Dictionary Building | 2 |
| Total Units Required | | 20–21 |

Preparation for State Certificate Examination

The courses listed are required to meet the requirements of the Court Reporter’s Board. This program was accredited by the CR Board on March 7, 1978. Academic courses completed in Adult Education or a private Court Reporting School are not transferable.

To earn a certificate, students must complete the required courses as listed with a minimum grade of “C.” At least 50% of all course work must be completed at Cypress College.

**STUDENTS MUST FURNISH
THEIR OWN MACHINE AND PAPER**

Required Courses are listed in suggested sequence:

| Course # | Title | Units |
|-----------------------------|---|-------------|
| SEMESTER 1 | | |
| CTRP 040 C | Beginning Machine Shorthand Theory | 3 |
| CTRP 041 C | Court Reporting Theory Review | 3 |
| CTRP 071 C | Legal Terminology and Rhetoric | 3 |
| MGT 055 C | Business English | 3 |
| CTRP 067 C | Basic Vocabulary Development | 2 |
| COUN 140 C | Educational Planning | .5 |
| Total Units Required | | 14.5 |
| SEMESTER 2 | | |
| CTRP 042 C, 043 C | Machine Shorthand Speed Building 1 and 2 | 4 |
| CTRP 051 C | Court/Conference Reporting: Legal | 3 |
| HS 145 C | Survey of Medical Terminology | 3 |
| *ENGL 106 C | Critical Thinking | 3 |
| MGT 041 C | Survey of Business Law | 3 |
| | or | |
| MGT 240 C | Legal Environment of Business | (3) |
| | or | |
| MGT 241 C | Legal Aspects-Business Transactions | (3) |
| | or | |
| MGT 141 C | Personal Law | (3) |
| CTRP 073AC | Spelling for Modern Business | 1 |
| CTRP 073BC | Punctuation for Court Reporting | 1 |
| Total Units Required | | 18 |
| SUMMER SESSION | | |
| CTRP 044 C, 045 C | Machine Shorthand Speed Building 3 and 4 | 4 |
| Total Units Required | | 4 |
| SEMESTER 3 | | |
| CTRP 057 C, 058 C | Machine Shorthand Challenge — 160 and 180 | 4 |
| CTRP 046 C | Machine Shorthand Speed Building 5 | 2 |
| CTRP 052 C | Court/Conference Reporting: Medical | 3 |
| CTRP 072 C | Legal Procedures | 4 |
| CTRP 054 C | Two/Four Voice Testimony | 3 |
| CTRP 085 C | Computer Aided Transcription: Dictionary Building | 1 |
| Total Units Required | | 17 |
| SEMESTER 4 | | |
| CTRP 059 C | Machine Shorthand Challenge — 200 | 2 |
| CTRP 047 C | Machine Shorthand Speed Building 6 | 2 |
| CTRP 053 C | Court/Conference Reporting: Congressional | 3 |
| CTRP 055 C, 056 C | Court/Conference Reporting: Jury Charge | 6 |
| CTRP 068 C | Adv. Vocabulary Development | 1.5 |
| CTRP 082 C | Computer Aided Transcription: ProCAT | 1 |
| | or | |
| CTRP 083 C | Computer Aided Transcription: Stenograph | (1) |
| | or | |
| CTRP 084 C | Computer Aided Transcription: Eclipse | (1) |
| | or | |
| CTRP 070 C | Computer Aided Transcription: Stenocat | (1) |
| MGT 143 C | Introduction to Legal Research | 1 |
| Total Units Required | | 16.5 |
| SUMMER SESSION | | |
| CTRP 048 C | Machine Shorthand Speed Building 7 | 2 |
| CTRP 060 C | Machine Shorthand Challenge — 220 | 2 |
| Total Units Required | | 4 |

| SEMESTER 5 | | |
|-----------------------------|----------------------------------|-------------|
| CTRP 076 C | Court and Deposition Procedures | 1.5 |
| CTRP 081 C | Internship: Court Reporting | 2 |
| *BIOL 160 C | Integrated Medical Science | 3 |
| | or | |
| HS 147 C | Survey of Disease | (3) |
| CTRP 074 C | CSR/RPR/CBC/CCP Exam Preparation | 1 |
| CTRP 092 C | Realtime Writing Concepts | 2 |
| Total Units Required | | 9.5 |
| Program Total Units | | 83.5 |

Note: Students are advised to contact a Business counselor for any questions regarding this program.

**CALIFORNIA COURT REPORTERS
BOARD ACCREDITATION
ACCREDITED COURT REPORTING PROGRAM**

In order for the person to qualify from a school to take the state licensing examination, the person shall complete a program at a recognized school. For information concerning the minimum requirements that a court reporting program must meet in order to be recognized contact:

The Court Reporter's Board of California
2535 Capitol Oaks Drive, Suite 230
Sacramento, CA 95833

*CYPRESS COLLEGE BUSINESS/CIS DIVISION
COURT REPORTING PROGRAM*

This program was approved by the Court Reporter's Board on March 7, 1978. Academic courses completed in Adult Education are not transferable. Courses taken in Distance Education will be evaluated on an individual basis for transferability and hour requirements. Private school academics may be evaluated for certification to take the CSR examination. The California Court Reporter's Board sets the standards for hours of training under the following listed categories. The Cypress College program exceeds all state requirements. The student may go on to earn an Associate in Arts Degree or other specialized certificate. Students must furnish their own equipment, paper, and other supplies. Students must enter the program with a basic typing speed of 25 words per minute.

1. Machine Shorthand and Transcription — 2300 hours (Lab hours do not count for machine credit in this category, per the CR Board.)

| CORE REQUIREMENTS: | | |
|------------------------------|--|-------------|
| CTRP 040 C | | 90 |
| CTRP 041 C | | 90 |
| CTRP 042 C–045 C | | 360 |
| CTRP 046 C–048 C | | 270 |
| CTRP 057 C–060 C | | 360 |
| CTRP 050 C | | 90 |
| CTRP 051 C | | 90 |
| CTRP 052 C | | 90 |
| CTRP 053 C | | 90 |
| CTRP 054 C | | 90 |
| CTRP 055 C | | 90 |
| CTRP 056 C | | 90 |
| CTRP 075 C | | 90 |
| CTRP 089 C or 090 C or 096 C | | 90 |
| Total Hours | | 1980 |

Core Requirements must be completed in order to qualify. Students must pass one ten (10) minute qualifier in CTRP 050 C to be eligible to take the state CSR licensing examination. Transfer students must demonstrate course comparability in speed building categories.

ELECTIVES — After completing the core requirements, students may gain additional machine hours by completing any of the following.

| | |
|------------------------------|------------|
| CTRP 049 C | 90 |
| CTRP 094 C | 36 |
| CTRP 095 C | 36 |
| CTRP 089 C or 090 C or 096 C | 90 |
| (SCE Speedbuilding 1, 2, 3) | 120 |
| Total Hours | 372 |

2. ENGLISH — 240 Hours required

| | | |
|--------------------|--|----------------|
| MGT 055 C | Business English | 54 |
| ENGL 103 C | Critical Reasoning and Writing | 72 |
| | or | |
| ENGL 106 C | Critical Reading, Writing and Thinking | (54) |
| CTRP 073AC | Spelling for Modern Business | 18 |
| CTRP 073BC | Punctuation for Court Reporting | 18 |
| CTRP 067 C | Basic Vocabulary Development | 36 |
| CTRP 068 C | Adv. Vocabulary Development | 27 |
| ENGL 135 C | Grammar and Usage | 54 |
| Total Hours | | 261–279 |

3. MEDICAL — 120 Hours required

| | | |
|--------------------|-------------------------------------|------------|
| HS 145 C | Survey of Medical Terminology | 54 |
| BIOL 160 C | Integrated Medical Science | 54 |
| | or | |
| HS 147 C | Survey of Disease | (54) |
| CTRP 052 C | Court/Conference Reporting: Medical | 18 |
| Total Hours | | 126 |

4. LEGAL — 150 Hours required

| | | |
|--------------------|-------------------------------------|------------|
| CTRP 071 C | Legal Terminology and Rhetoric | 54 |
| MGT 041 C | Survey of Business Law | |
| | or | |
| MGT 141 C | Survey of Personal Law | |
| | or | |
| MGT 240 C | Legal Environment of Business | |
| | or | |
| MGT 241 C | Legal Aspects-Business Transactions | 54 |
| CTRP 076 C | Court and Depositions Procedures | 54 |
| Total Hours | | 162 |

5. KEYBOARDING: 45 words per minute net
(Cypress requirement 50 net words per minute)

| | | |
|------------|------------------|----|
| CTRP 072 C | Legal Procedures | 90 |
|------------|------------------|----|

6. TRANSCRIPT PREPARATION — 25 Hours required

| | | |
|--------------------|------------------------------|-----------|
| CTRP 073CC | Formatting, Style, and Usage | 18 |
| CTRP 073DC | Proofreading | 18 |
| Total Hours | | 36 |

7. RESOURCE MATERIALS — 5 Hours required

| | | |
|--------------------|--------------------------------|-----------|
| MGT 143 C | Introduction to Legal Research | 18 |
| Total Hours | | 18 |

8. APPRENTICESHIP TRAINING/COURT OBSERVATION — 60 Hours required

| | | |
|---|-------------------------------------|-----------|
| CTRP 081 C | Internship - Court Reporting | 36 |
| | 20 Hours — Court | |
| | 20 Hours — Deposition | |
| | 10 Hours — Observation — Off Campus | |
| | (prior to 140 wpm) | |
| Observation Hours may be completed in various classes | | |
| CTRP 074 C | CSR-RPR-CBC-CCP Exam Preparation | 27 |
| Total Hours | | 63 |

9. TECHNOLOGY — 60 Hours required

| | | |
|------------|---|----|
| CTRP 092 C | Realtime Writing Concepts | 36 |
| CTRP 085 C | Computer Aided Transcription: Dictionary Building | 36 |
| CTRP 093 C | Information Technology - CTRP | 36 |

SELECT ONE OF THE FOLLOWING: 18–36

| | | |
|------------|---|--|
| CTRP 082 C | Computer Aided Transcription: ProCAT | |
| CTRP 083 C | Computer Aided Transcription - Stenograph | |
| CTRP 084 C | Computer Aided Transcription - Eclipse | |
| CTRP 070 C | Computer Aided Transcription - Stenocat | |

Suggested Elective:

| | | |
|--------------------|----------------------|------------|
| CTRP 065 C | Advanced CAT Systems | (36) |
| Total Hours | | 108 |

NOTE: An 18,000 word dictionary is required in order to take the CSR examination.

In order for a person to qualify from a school to take the state licensing examination, the person shall complete a program at a recognized school. For more information contact:

**Department of Consumer Affairs
The Court Reporter's Board of California
2535 Capitol Oaks Drive, Suite 230
Sacramento, CA 92583
(916) 263-3660**

All candidates must have a high school diploma or equivalent to take the CSR examination.

*Section 2411(a)(7) of the CR Board regulations state that a student will be allowed a reduction in the required machine hours if a student is able to pass the qualifier examination before completing the hours described in Section 1 under Machine Shorthand and Transcription. This does not exempt a student from completing the core required classes in order to qualify.

(Revised April, 2008)

CAPTIONING CERTIFICATE Program Code: 1C31330

The Captioning Certificate is designed to prepare students who are interested in pursuing careers in broadcast captioning, both online and off-line, using the latest in realtime technology with specific application software. Students will be encouraged to explore all areas of the captioning arena for future possible employment opportunities.

To earn a certificate, complete the required courses as listed with a minimum grade of "C." At least 50% of all course work must be completed at Cypress College.

| Required courses are listed in suggested sequence: | | Units |
|---|---|--------------|
| CTRP 085 C | Computer Aided Transcription: Dictionary Building | 2 |
| CTRP 090 C | Court/Conference Reporting: Literary | 3 |
| CTRP 089 C | Court/Conference Reporting: Literary II | 3 |
| CTRP 096 C | Court/Conference Reporting: Literary III | 3 |
| CTRP 092 C | Realtime Writing Concepts | 2 |
| CTRP 088 C | Internship: Captioning | 3 |
| CTRP 068 C | Advanced Vocabulary Development | 1.5 |
| CTRP 091 C | Advanced Dictionary Build | 2 |
| Total Units Required | | 19.5 |

**CART - COMMUNICATION ACCESS
REALTIME TRANSLATION Program Code: 1C07821**

**STUDENTS MUST FURNISH
THEIR OWN MACHINE AND PAPER**

The CART (Communication Access Realtime Translation) Certificate will provide the student with an opportunity for future employment as a classroom captionist shadowing a hearing-impaired individual, providing a realtime translation of all proceedings. The training program provides for an internship experience, where students will learn first-hand the job duties of a CART reporter.

To earn a certificate, complete the required courses as listed with a minimum grade of "C." At least 50% of all course work must be completed at Cypress College.

| Required courses are listed in suggested sequence: | | Units |
|---|---|--------------|
| CTRP 040 C | Beginning Machine Shorthand Theory | 3 |
| CTRP 041 C | Court Reporting Theory Review | 3 |
| CTRP 042 C | Machine Shorthand Speed Building 1 | 2 |
| CTRP 043 C | Machine Shorthand Speed Building 2 | 2 |
| CTRP 044 C | Machine Shorthand Speed Building 3 | 2 |
| CTRP 045 C | Machine Shorthand Speed Building 4 | 2 |
| CTRP 051 C | Court/Conference Reporting: Legal | 3 |
| CTRP 052 C | Court/Conference Reporting: Medical | 3 |
| CTRP 067 C | Basic Vocabulary Development | 2 |
| CTRP 068 C | Advanced Vocabulary Development | 1.5 |
| CTRP 092 C | Realtime Writing Concepts | 2 |
| CTRP 079 C | Internship - CART | 3 |
| CTRP 090 C | Court/Conference Reporting: Literary | 3 |
| CTRP 089 C | Court/Conference Reporting: Literary II | 3 |
| Total Units Required | | 34.5 |

**COMPUTER EDITOR (SCOPIST)
CERTIFICATE Program Code: 1C07820**

**STUDENTS MUST FURNISH
THEIR OWN MACHINE AND PAPER**

The Computer Editor (Scopist) Certificate prepares the student for employment in the field of court reporting working one-on-one with a Certified Shorthand Reporter to prepare and edit official transcripts for court, depositions, hearings, and other venues.

To earn a certificate, the student must complete the required courses as listed with a minimum grade of "C." At least 50% of all course work must be completed at Cypress College.

| Required courses are listed in suggested sequence: | | Units |
|---|---|--------------|
| CIS 100 C | Introduction to Computer and Windows Concepts | 3 |
| | or | |
| CIS 111 C | Computer Information Systems | (3) |
| CIS 107 C | Introduction to Windows | 2 |
| CTRP 040 C | Beginning Machine Shorthand Theory | 3 |
| CTRP 041 C | Court Reporting Theory Review | 3 |
| CTRP 071 C | Legal Terminology and Rhetoric | 3 |
| CTRP 073AC | Spelling for Modern Business | 1 |
| CTRP 073BC | Punctuation for Court Reporting | 1 |
| CTRP 073CC | Formatting, Style and Usage | 1 |
| CTRP 097 C | Internship: Scoping/Editing | 1.5 |

| Select a minimum of four units from the following courses: | | Units |
|---|---|--------------|
| Electives: | | |
| CTRP 082 C | Computer Aided Transcription: ProCAT | 1 |
| CTRP 083 C | Computer Aided Transcription - Stenograph | 2 |
| CTRP 084 C | Computer Aided Transcription - Eclipse | 2 |
| CTRP 070 C | Computer Aided Transcription: Stenocat | 1 |
| HS 145 C | Survey of Medical Terminology | 3 |
| MGT 055 C | Business English | 3 |
| MGT 143 C | Introduction to Legal Research | 1 |
| CTRP 067 C | Basic Vocabulary Development | 2 |
| CTRP 068 C | Advanced Vocabulary Development | 1.5 |
| Total Units Required | | 22.5 |

**COURT AND AGENCY SERVICES
CERTIFICATE Program Code: 1C30333**

The Court and Agency Services Certificate will provide the student with the necessary knowledge, skills, and training to be employed in the field of court and/or deposition agency administration and operations. The training provides for an internship experience of 40 hours.

To earn a certificate, the student must complete the required courses as listed with a minimum grade of "C." At least 50% of all course work must be completed at Cypress College.

| Required courses are listed in the suggested sequence: | | Units |
|---|--|--------------|
| CTRP 073AC | Spelling for Modern Business | 1 |
| CTRP 073BC | Punctuation for Court Reporting | 1 |
| CTRP 073CC | Formatting, Style and Usage | 1 |
| CTRP 073DC | Proofreading | 1 |
| CIS 102 C | Advanced MS Word Business Applications | 4 |
| CTRP 071 C | Legal Terminology and Rhetoric | 3 |
| CTRP 072 C | Legal Procedures | 4 |
| CTRP 076 C | Court and Deposition Procedures | 3 |
| CTRP 093 C | Information Technology — CTRP | 2 |
| MGT 143 C | Introduction to Legal Research | 1 |
| CTRP 033 C | Internship: Agency Services | 2 |
| | or | |
| CTRP 034 C | Internship: Court Services | (2) |
| CTRP 062 C | Notary Public Exam Preparation | 1 |
| Total Units Required | | 24 |

ASSOCIATE IN SCIENCE DEGREE LAW OFFICE ADMINISTRATION

Program Code: 1S32966

The Law Office Administration AS degree prepares the student for a career in the legal arena. The curriculum is designed to develop a working knowledge of the legal field. The objective of the Law Office Administration AS degree is to provide skill-based training through traditional teaching methods with an emphasis on practical and hands-on application of subject matter, along with a 40-hour internship in the field.

To earn an Associate Degree students must complete (1) all major course requirements with a minimum grade of "C"; (2) 25 units of General Education Graduation Requirements; (3) the cultural diversity and reading requirements; (4) any elective course to complete a minimum of 60 units; and (5) have a minimum GPA of 2.0. At least 50 percent of all major course work must be completed at Cypress College.

| Required courses are listed in suggested sequence: | | Units |
|---|-------------------------------------|------------------|
| CTRP 073AC | Spelling for Modern Business | 1 |
| CTRP 073BC | Punctuation for Court Reporting | 1 |
| CTRP 071 C | Legal Terminology and Rhetoric | 3 |
| CTRP 072 C | Legal Procedures | 4 |
| MGT 055 C | Business English | 3 |
| MGT 143 C | Introduction to Legal Research | 1 |
| CTRP 067 C | Basic Vocabulary Development | 2 |
| CTRP 068 C | Advanced Vocabulary Development | 1.5 |
| CTRP 076 C | Court and Deposition Procedures | 0.5–3 |
| CTRP 073DC | Proofreading | 1 |
| CTRP 073CC | Formatting, Style and Usage | 1 |
| CTRP 062 C | Notary Public Exam Preparation | 0.5–1 |
| CTRP 080 C | Internship: Law Office | 2 |
| | or | |
| CTRP 033 C | Internship: Agency Services | (2) |
| | or | |
| CTRP 034 C | Internship: Court Services | (2) |
| MGT 240 C | Legal Environment of Business | 3 |
| | or | |
| MGT 241 C | Legal Aspects-Business Transactions | (3) |
| Total Units Required | | 24.5–27.5 |

LEGAL TRANSCRIPTION CERTIFICATE

Program Code: 1C33356

This certificate prepares the student for employment in law offices, council meetings, police departments, and hearings recording and/or transcribing taped proceedings. To earn a certificate, the student must complete the required courses as listed with a minimum grade of "C". At least 50 percent of all coursework must be completed at Cypress College.

| Required courses are listed in the suggested sequence: | | Units |
|---|---|------------------|
| CTRP 071 C | Legal Terminology and Rhetoric | 3 |
| MGT 240 C | Legal Environment of Business | 3 |
| MGT 143 C | Introduction to Legal Research | 1 |
| MGT 055 C | Business English | 3 |
| CTRP 072 C | Legal Procedures | 4 |
| CTRP 073DC | Proofreading | 1 |
| CTRP 067 C | Basic Vocabulary Development | 2 |
| CTRP 068 C | Advanced Vocabulary Development | 1.5 |
| CTRP 055 C | Court/Conference Reporting: Jury Charge | .5–3 |
| CTRP 056 C | Court/Conference Reporting: Jury Charge 2 | .5–3 |
| Total Units Required | | 19.5–24.5 |

COURT REPORTING TECHNOLOGY CERTIFICATE

Program Code: 1C33369

This certificate prepares the student to work in the field of court reporting with a high degree of knowledge of the technology required to produce a finished transcript or court and deposition-related document. To earn a certificate, the student must complete the required courses as listed with a minimum grade of "C". At least 50 percent of all coursework must be completed at Cypress College.

| Required courses are listed in the suggested sequence: | | Units |
|---|--|--------------|
| CTRP 070 C | Computer Aided Transcription: Stenocat | 1 |
| | or | |
| CTRP 082 C | Computer Aided Transcription: ProCAT | (1) |
| | or | |
| CTRP 083 C | Computer Aided Transcription - Stenograph | (2) |
| | or | |
| CTRP 084 C | Computer Aided Transcription - Eclipse | (2) |
| CTRP 085 C | Computer Aided Transcription - Dictionary Building | 2 |
| CTRP 065 C | Advanced CAT Systems | 2 |
| CTRP 091 C | Advanced Dictionary Build | 2 |
| CTRP 092 C | Realtime Writing Concepts | 2 |
| CTRP 093 C | Information Technology - CTRP | 2 |
| CTRP 051 C | Court/Conference Reporting: Legal | 3 |
| CTRP 052 C | Court/Conference Reporting: Medical | 3 |
| CTRP 053 C | Court/Conference Reporting: Congressional | 3 |
| CTRP 039 C | Internship - Legal Transcription | 3 |
| Total Units Required | | 23–24 |

HEARING REPORTER CERTIFICATE

Program Code: 1C33368

This certificate provides the student with the necessary knowledge, skills, and background to work in the field of convention reporting, hearing reporting, police department reporting, congressional reporting, and related fields. To earn a certificate, the student must complete the required courses as listed with a minimum grade of "C". At least 50 percent of all coursework must be completed at Cypress College.

| Required courses are listed in the suggested sequence: | | Units |
|---|---|--------------|
| CTRP 090 C | Court/Conference Reporting: Literary | 3 |
| CTRP 052 C | Court/Conference Reporting: Medical | 3 |
| CTRP 056 C | Court/Conference Reporting: Jury Charge 2 | 3 |
| CTRP 053 C | Court/Conference Reporting: Congressional | 3 |
| CTRP 087 C | Internship: Hearing Reporter | 3 |
| CTRP 092 C | Realtime Writing Concepts | 2 |
| CTRP 055 C | Court/Conference Reporting: Jury Charge | 3 |
| Total Units Required | | 20 |

LEGAL ADMINISTRATIVE ASSISTANT CERTIFICATE **Program Code: 1C30459**

This certificate prepares the student to work in a variety of venues related to the legal profession including positions as a legal administrative assistant in a law office, or in the court system, and in a variety of other legal settings.

To earn a certificate, complete the required courses as listed with a minimum grade of “C.” At least 50% of all course work must be completed at Cypress College.

| Required courses are listed in suggested sequence: | | Units |
|---|--|--------------|
| CTRP 073AC | Spelling for Modern Business | 1 |
| CTRP 073BC | Punctuation for Court Reporting | 1 |
| CTRP 071 C | Legal Terminology and Rhetoric | 3 |
| CIS 102 C | Advanced MS Word Business Applications | 4 |
| CTRP 072 C | Legal Procedures | 4 |
| CIS 150 C | Microsoft Office Applications | 3 |
| MGT 055 C | Business English | 3 |
| MGT 143 C | Introduction to Legal Research | 1 |
| CTRP 080 C | Internship: Law Office | 2 |
| Total Units Required | | 22 |

PROOFREADING CERTIFICATE **Program Code: 1C31331**

This certificate provides the student with the necessary knowledge, skills, and background to work in the field of court reporting as a proofreader.

To earn a certificate, a student must complete the required courses as listed with a minimum grade of “C.” At least 50% of all course work must be completed at Cypress College.

| Required courses are listed in suggested sequence: | | Units |
|---|------------------------------------|--------------|
| CTRP 040 C | Beginning Machine Shorthand Theory | 3 |
| CTRP 041 C | Court Reporting Theory Review | 1–3 |
| CTRP 073AC | Spelling for Modern Business | 1 |
| CTRP 073BC | Punctuation for Court Reporting | 1 |
| CTRP 073CC | Formatting, Style and Usage | 1 |
| CTRP 073DC | Proofreading | 1 |
| CTRP 067 C | Basic Vocabulary Development | 2 |
| CTRP 068 C | Advanced Vocabulary Development | 1.5 |
| MGT 055 C | Business English | 3 |
| CTRP 086 C | Internship - Proofreading | 1.5 |
| CTRP 093 C | Information Technology-CTRP | 2 |
| Total Units Required | | 18–20 |

Court Reporting (CTRP)

CTRP 030 C CR Beginning Practice Lab 1 to 6 Units

Term hours: 54-324 laboratory depending on units attempted. This course is designed as an open entry lab to fulfill the Court Reporter’s Board lab requirements for court reporting students receiving instruction in theory to 100 words per minute. Fifty-four hours is required for one unit of credit. Variable Unit Class. May be taken for a cumulative total of 6 units. Open Entry/Open Exit. Pass/No Pass only. \$3.00 Material Fee-Payable at Registration.

CTRP 031 C CR Intermediate Practice Lab 1 to 6 Units

Term hours: 54-324 laboratory depending on units attempted. This course is designed as an open entry skill building lab to fulfill the Court Reporter’s Board lab requirements for students receiving instruction from 110 to 140 words per minute. Fifty-four hours is required for one unit of credit. May be taken for a cumulative total of 6 units. Open Entry/Open Exit. Pass/No Pass. \$3.00 Material Fee - Payable at Registration.

CTRP 033 C Internship: Agency Services 2 Units

Term hours: 36 lecture and forty hours of internship plus ten hours of observation. This course provides practical work experience in an office setting in order to prepare the student to work in a court reporting agency. There will be 40 hours of internship required, plus 10 hours of observation.

CTRP 034 C Internship: Court Services 2 Units

Term hours: 36 lecture and forty hours of internship plus ten hours of observation. This course provides practical work experience in order to prepare the student to work in an administrative or clerical capacity in the California court system. There will be 40 hours of internship required, along with 10 hours of observation.

CTRP 035 C Advanced Practice Lab 1 to 6 Units

Term hours: 54-324 laboratory depending on units attempted. This course is designed as an open entry skill building lab to fulfill the California Court Reporter’s Board lab requirements for students receiving instruction from 140 to 180 words per minute. Fifty-four hours is required for one unit of credit. May be taken for a cumulative total of 6 units. Open Entry/Open Exit. Pass/No Pass. \$3.00 Material Fee - Payable at Registration.

CTRP 036 C CR High Speed Proficiency Lab 1 to 6 Units

Term hours: 54-324 laboratory depending on units attempted. This course is designed as an open entry skill building lab to fulfill the California Court Reporter’s Board lab requirements for students receiving instruction from 180 to 220 words per minute. May be taken for a cumulative total of 6 units. Open Entry/Open Exit. Pass/No pass. \$3.00 Material Fee-Payable at Registration.

CTRP 037 C CR Qualifier Lab 1 to 6 Units

Term hours: 54-324 laboratory depending on units attempted. This course is designed as an open entry skill building lab to fulfill the California Court Reporter’s Board lab requirements for students in the qualifier program. Fifty-four hours is required for one unit of credit. May be taken for a cumulative total of 6 units. Open Entry/Open Exit. Pass/No Pass. \$3.00 Material Fee-Payable at Registration.

CTRP 038 C Computer Aided Transcription Lab 1 to 6 Units

Term hours: 54-324 depending on units taken. This course is designed as an open entry skill building lab to fulfill the California Court Reporter’s Board lab requirements for students in the CAT (Computer Assisted Transcription) classes. 54 hours is required for one unit of credit. May be taken for a cumulative total of 6 units. Pass/No Pass. \$3.00 Materials Fee-Payable at registration.

CTRP 039 C Internship – Legal Transcription 3 units

Term hours: 36 lecture and 54 laboratory. This course offers practical work experience in legal transcription for future employment in law offices, police departments, court reporting agencies, and other venues. Internship may be paid or unpaid. There will be 50 hours of internship, plus 10 hours of observation. Pass/No pass/letter grade option.

CTRP 040 C Beginning Machine Shorthand Theory 3 Units

Term hours: 36 lecture and 54 laboratory. This first semester course covers the basic theory of machine shorthand and mastery of the keyboard. This course meets partial requirements of the Court Reporter’s Board and the National Court Reporter’s Association. Recommend concurrent enrollment in CTRP 041 C. Three hours of court observation required. Pass/No Pass/Letter Grade Option.

CTRP 041 C Court Reporting Theory Review 1 to 3 Units

Term hours: 36 lecture and 54 laboratory depending on units attempted. This course covers the review of basic theory of court reporting which emphasizes reporting theory, reading fluency, and transcribing skills. This course meets partial requirements of the Court Reporter's Board and the National Court Reporter's Association. May be taken for credit 4 times. Open Entry/Open Exit. Pass/No Pass/Letter Grade Option.

CTRP 042 C Machine Shorthand Speed Building 1 .5 to 2 Units

Term hours: 18 lecture and 72 laboratory depending on units attempted. This course promotes further development of speed and accuracy in taking dictation on the machine. The student will review theory and develop sufficient skills to take new material dictation at 80 wpm for a minimum of three minutes with 95 percent accuracy. Units of credit will be granted when the speed and accuracy objective is attained. This course meets partial requirements of the Court Reporter's Board and the National Court Reporter's Association. May be taken for credit 4 times. Open Entry/Open Exit. Pass/No Pass/Letter Grade Option.

CTRP 043 C Machine Shorthand Speed Building 2 .5 to 2 Units

Term hours: 18 lecture and 72 laboratory depending on units attempted. This course promotes further development of speed and accuracy in taking dictation on the machine. The student will review theory and develop sufficient skills to take new material dictation at 100 wpm for a minimum of five minutes with 95 percent accuracy. Units of credit will be granted when the speed and accuracy objective is attained. This course meets partial requirements of the Court Reporter's Board and the National Court Reporter's Association. May be taken for credit 4 times. Open Entry/Open Exit. Pass/No Pass/Letter Grade Option.

CTRP 044 C Machine Shorthand Speed Building 3 .5 to 2 Units

Term hours: 18 lecture and 72 laboratory depending on units attempted. This course promotes further development of speed and accuracy in taking dictation on the steno machine. The student will review techniques of writing and develop sufficient skills to take new material dictation at 120 wpm for five minutes with 95 percent accuracy. Units of credit will be granted when the speed and accuracy objective is attained. The course meets partial requirements of the Court Reporter's Board and the National Court Reporter's Association for speed level on jury charge material. May be taken for credit 4 times. Open Entry/Open Exit. Pass/No Pass/Letter Grade Option.

CTRP 045 C Machine Shorthand Speed Building 4 .5 to 2 Units

Term hours: 18 lecture and 72 laboratory depending on units attempted. This course promotes further development of speed and accuracy in taking dictation on the steno machine. The student will review techniques of writing and develop sufficient skills to take new material dictation at 140 wpm for five minutes with 95 percent accuracy. Units of credit will be granted when the speed and accuracy objective is attained. This course meets partial requirements of the Court Reporter's Board and the National Court Reporter's Association for speed level on jury charge material. May be taken for credit 4 times. Open Entry/Open Exit. Pass/No Pass/Letter Grade Option.

CTRP 046 C Machine Shorthand Speed Building 5 .5 to 2 Units

Term hours: 18 lecture and 72 laboratory depending on units attempted. This course promotes further development of speed and accuracy in taking dictation on the steno machine. The student will develop sufficient skills to take new material dictation at 160 wpm for five minutes with 98 percent accuracy. Units of credit will be granted when the speed and accuracy objective is attained. This course meets the requirements of the Court Reporter's Board and the National Court Reporter's Association for speed level on question and answer and trial testimony. May be taken for credit 4 times. Open Entry/Open Exit. Pass/No Pass/Letter Grade Option.

CTRP 047 C Machine Shorthand Speed Building 6 .5 to 2 Units

Term hours: 18 lecture and 72 laboratory depending on units attempted. This course promotes further development of speed and accuracy in taking dictation on the steno machine. The student will develop sufficient skills to take new material dictation at 180 wpm for ten minutes with 98 percent accuracy. Units of credit will be granted when the speed and accuracy objective is attained. This course meets the requirements of the Court Reporter's Board and the National Court Reporter's Association for speed level on question and answer and trial testimony. May be taken for credit 4 times. Open Entry/Open Exit. Pass/No Pass/Letter Grade Option.

CTRP 048 C Machine Shorthand Speed Building 7 .5 to 2 Units

Prerequisite: Completion of CTRP 047 C.

Term hours: 18 lecture and 72 laboratory depending on units attempted. This course promotes further development of speed and accuracy in taking dictation on the machine. The student will develop sufficient skills to take new material dictation at 200 wpm for 10 minutes with 98 percent accuracy. Units of credit will be granted when the speed and accuracy objective is attained. This course meets the requirements of the Court Reporter's Board and the National Court Reporter's Association for speed level on question and answer and trial testimony. May be taken for credit 4 times. Open Entry/Open Exit. Pass/No Pass/Letter Grade Option.

CTRP 049 C Machine Shorthand Speed Building 8 .5 to 2 Units

Prerequisite: Completion of CTRP 048 C.

Term hours: 18 lecture and 72 laboratory depending on units attempted. This course promotes further development of speed and accuracy in taking dictation on the machine. The student will develop sufficient skills to take new material at 200 and 220 wpm sustained dictation with 98 percent accuracy. Units of credit will be granted when the speed and accuracy objective is attained. This course meets the requirements of the Court Reporter's Board and the National Court Reporter's Association for speed level on question and answer and trial testimony. May be taken for credit 4 times. Open Entry/Open Exit. Pass/No Pass/Letter Grade Option.

CTRP 050 C CSR/RPR Directed Practice .5 to 2 Units

Term hours: 18 lecture and 72 laboratory depending on units attempted. This course promotes a further development of speed and accuracy in taking dictation on the machine. The student will develop sufficient skills to take new material dictation at speeds up to 240/260 wpm. Units of credit will be granted when the speed and accuracy objective is attained. This course meets the requirements of the Court Reporter's Board and the National Court Reporter's Association for speed level on question and answer and trial testimony. May be taken for credit 4 times. Open Entry/Open Exit. Pass/No Pass/Letter Grade Option.

CTRP 051 C Court/Conference Reporting: Legal 1 to 3 Units

Term hours: 36 lecture and 54 laboratory depending on units attempted. This course consists of an application of court reporting theory to the keyboard to develop dictation rates of 60–100 wpm for a minimum of three minutes with 95 percent accuracy. Emphasis is on jury charge, literary, and question and answer material. Legal vocabulary, California formatting, and court reporting punctuation rules are introduced. Three hours of court observation required. May be taken for credit 4 times. Open Entry/Open Exit. Pass/No Pass/Letter Grade Option.

CTRP 052 C Court/Conference Reporting: Medical 1 to 3 Units

Term hours: 36 lecture and 54 laboratory depending on units attempted. This course applies court reporting theory to the steno keyboard to develop dictation rates of 120–140 words per minute for a minimum of three minutes with 95 percent accuracy with emphasis on medical terminology. Three hours of court observation required. May be taken for credit 4 times. Open Entry/Open Exit. Pass/No Pass/Letter Grade Option.

CTRP 053 C Court/Conference Reporting: Congressional 1 to 3 Units

Term hours: 36 lecture and 54 laboratory depending on units attempted. This course offers further development of speed and accuracy on the steno machine in taking dictation to increase machine shorthand speed and strengthen transcription skills with emphasis on congressional record material, at speeds ranging from 160–180 wpm for a minimum of three minutes with 95 percent accuracy. May be taken for credit 4 times. Open Entry/Open Exit.

CTRP 054 C Two/Four Voice Testimony .5 to 3 Units

Term hours: 36 lecture and 54 laboratory depending on units attempted. This course develops familiarity with a simulated courtroom scene consisting of the judge, the clerk, attorneys for the plaintiff and the defendant, and a witness participating in two and four voice dictation. Students will identify each speaker with appropriate machine designations in multi-voice testimony at 120–140 words per minute for a minimum of three minutes, transcribed in proper format with 98 percent accuracy. May be taken for credit 4 times. Open Entry/Open Exit. Pass/No Pass/Letter Grade Option.

CTRP 055 C Court/Conference Reporting: Jury Charge .5 to 3 Units

Term hours: 36 lecture and 54 laboratory depending on units attempted. This course presents an intensive application of court reporting theory to develop further reading and transcribing skills in jury charge, opening and closing arguments, legal opinion and other courtroom material at speeds ranging from 160 to 180 wpm. This course prepares the student for the machine portion of the RPR examination. May be taken for credit 4 times. Open Entry/Open Exit. Pass/No Pass/Letter Grade Option.

CTRP 056 C Court/Conference Reporting: Jury Charge 2 .5 to 3 Units

Term hours: 36 lecture and 54 laboratory depending on units attempted. This course presents an intensive application of court reporting theory to develop further reading and transcribing skills in jury charge, opening and closing arguments, legal opinion and other courtroom material at speeds ranging from 180 to 200 wpm. This course prepares the student for the machine portion of the RPR examination. May be taken for credit 4 times. Open Entry/Open Exit. Pass/No Pass/Letter Grade Option.

CTRP 057 C Machine Shorthand Challenge-160 .5 to 2 Units

Prerequisite: CTRP 045 C and CTRP 054 C.

Term hours: 18 lecture and 72 laboratory depending on units attempted. This course is designed for the advanced court reporting student and the transfer student to gain additional proficiency in taking multiple-voice testimony in a simulated environment at 160 wpm. Live reading will be introduced. May be taken for credit 4 times. Open Entry/Open Exit. Pass/No Pass/Letter Grade Option.

CTRP 058 C Machine Shorthand Challenge-180 .5 to 2 Units

Prerequisite: CTRP 057 C.

Term hours: 18 lecture and 72 laboratory depending on units attempted. This course is designed for the advanced court reporting student and the transfer student to gain additional proficiency in taking multiple-voice testimony in a simulated environment at 180 wpm. Live reading will be introduced. May be taken for credit 4 times. Open Entry/Open Exit. Pass/No Pass/Letter Grade Option.

CTRP 059 C Machine Shorthand Challenge-200 .5 to 2 Units

Prerequisite: CTRP 058 C.

Term hours: 18 lecture and 72 laboratory depending on units attempted. This course is designed for the advanced court reporting student and the transfer student to gain additional proficiency in taking multiple-voice testimony in a simulated environment at 200 wpm. Videotaped testimony and live reading will be introduced. May be taken for credit 4 times. Open Entry/Open Exit. Pass/No Pass/Letter Grade Option.

CTRP 060 C Machine Shorthand Challenge-220 .5 to 2 Units

Prerequisite: CTRP 059 C.

Term hours: 18 lecture and 72 laboratory depending on units attempted. This course is designed for the advanced court reporting student to gain additional proficiency in taking multiple-voice testimony in a simulated environment at 220 wpm. Videotaped testimony and live reading will be introduced. May be taken for credit 4 times. Open Entry/Open Exit. Pass/No Pass/Letter Grade Option.

CTRP 062 C Notary Public Exam Preparation .5 to 1 Units

Term hours: 9–18 lecture depending on units attempted. This course is designed to prepare students to take and pass the California State Notary Public examination. May be taken for credit 2 times. Open Entry/Open Exit. Pass/No Pass/Letter Grade Option.

CTRP 065 C Advanced CAT Systems 2 Units

Advisory: The student must have completed a CAT (Computer-Aided Transcription) dictionary.

Term hours: 18 lecture and 54 laboratory. This course is designed as an advanced CAT (Computer Aided Transcription) class to provide further instruction in CAT based court reporting software programs. A heavy emphasis will be placed on document production.

CTRP 066 C Machine Transcription-Medical 2 Units

Prerequisite: CIS 101 C, or CIS 125 C, or a minimum of 20 wpm.

Advisory: HS 145 C or a knowledge of medical terminology is recommended.

Term hours: 18 lecture and 54 laboratory. This course is designed to teach medical transcription skills. Physician's correspondence, case histories, and reports will be transcribed using transcribing machines and a personal computer. \$3.00 Material Fee-Payable at Registration. Pass/No Pass/Letter Grade Option.

CTRP 067 C Basic Vocabulary Development 2 Units

Term hours: 36 lecture. This course is a basic course designed to enrich vocabulary and improve spelling. The emphasis is on increasing general business and professional terminology.

CTRP 068 C Advanced Vocabulary Development 1.5 Units

Term hours: 27 lecture. This course is an advanced course designed to enrich vocabulary and improve spelling. The emphasis is on increasing general business and professional terminology.

CTRP 070 C Computer Aided Transcription: Stenocat 1 Unit

Term hours: 18 lecture and 54 laboratory TBA. This course uses computer-based instruction as well as hands-on applications to introduce the court reporting student to Stenocat Computer Aided Transcription software using personal computers.

CTRP 071 C Legal Terminology and Rhetoric 3 Units

Term hours: 54 lecture. The course includes instruction in the terminology used in legal proceedings and legal documents. The topics covered include terminology in civil and criminal litigation and cases in equity.

CTRP 072 C Legal Procedures 4 Units

Term hours: 72 lecture and 18 laboratory. This course is designed to train the legal secretarial, paralegal, or court reporting student in legal procedures and practical law office skills and knowledge in the areas of general office duties, non-court documents, the courts, court documents, litigation, appeals, and other court actions. This course may be taught using a computer. Three hours of court observation required.

CTRP 073AC Spelling for Modern Business 1 Unit

Term hours: 18 lecture. This course is designed as an 18-hour intensive review of frequently misspelled words, homonyms, synonyms, and antonyms. The emphasis will be on business, legal, medical, and technical terminology. This course meets partial requirements of the Court Reporter's Board for the English requirements for the CSR Certification Program.

CTRP 073BC Punctuation for Court Reporting 1 Unit

Term hours: 18 lecture. This course is designed as an 18-hour intensive review of punctuation styles and rules used in court documents, letters, legal office documents, contracts, memorandums, and reports. The emphasis will be on basic punctuation rules as they apply to written business, legal, medical, and technical documents. This course meets partial requirements of the Court Reporter's Board for English and the CSR Certification Program.

CTRP 073CC Formatting, Style and Usage 1 Unit

Term hours: 18 lecture. This course is designed to provide the court reporting student and the computer editor (scopist) major with instruction in preparing and formatting California court transcripts and depositions. Instruction will include format styles, usage, and fundamentals of document production using the computer.

CTRP 073DC Proofreading 1 Unit

Term hours: 18 lecture. This course is designed to provide the court reporting student with instruction in editing and proofreading in order to prepare a final California court transcript, deposition, hearing transcript or other related legal document.

CTRP 074 C CSR-RPR-CBC-CCP**Exam Preparation .5 to 3 Units**

Term hours: 9-54 lecture depending on units attempted. This course is designed to prepare the student to successfully pass the written portion of any or all of the following examinations: CSR, RPR, CBC or CCP. May be taken for a cumulative total of 3 units. Pass/No Pass only. Open Entry/Open Exit.

CTRP 075 C Simulated Courtroom .5 to 6 Units

Prerequisite: CTRP 046 C.

Term hours: 18 lecture and 72 laboratory depending on units attempted. This course is designed to offer a simulated courtroom and deposition environment with special emphasis on live reading with 2-, 3-, 4-, and 5-voice dictation practice at speeds ranging from 180 to 200 wpm. May be taken for a cumulative total of 6 units. Open Entry/Open Exit.

CTRP 076 C Court and Deposition Procedures 1.5 to 3 Units

Term hours: 27-54 lecture depending on units attempted. This course provides intensive training in court and deposition procedures with heavy emphasis on court structure, pre-trial and trial procedures, law office procedures, ethics, and document production. May be taken for a cumulative total of 3 units. Open Entry/Open Exit.

CTRP 077 C Dictation and Transcription .5 to 6 Units

Term hours: 9-108 lecture and 18-216 laboratory depending on units attempted. This course provides further development of speed and accuracy in taking dictation on the machine at a variety of speeds. Emphasis is on reinforcement and improvement. May be taken for a cumulative total of 6 units. Open Entry/Open Exit. Pass/No Pass only.

CTRP 078 C Internship: Medical Reporting 2 Units

Term hours: 36 lecture and forty hours of internship plus ten hours of observation. This course is designed to provide the court reporting medical transcriptionist student with practical work experience recording and reporting medical lectures, seminars, and hearings. There will be 40 hours of internship plus 10 hours of observation.

CTRP 079 C Internship - CART 3 Units

Term hours: 36 lecture and 54 laboratory TBA. This course is designed to provide the CART (Communication Access Realtime Translation) student with practical work experience recording and reporting seminars, hearings, and lectures. Internships may be paid or unpaid. There will be 50 hours of internship plus 10 hours of observation.

CTRP 080 C Internship: Law Office 2 Units

Term hours: 36 lecture and forty hours in a law office or legal environment plus ten hours of observation. This course offers practical work experience in an approved law office in the County of Orange or Los Angeles. Internship will be scheduled during the semester, depending on available law office openings. This course fulfills partial requirements of the Law Office Administration degree and the Legal Administrative Assistant Certificate. 40 hours of internship in the field, along with 10 hours of observation.

CTRP 081 C Internship - Court Reporting 3 Units

Prerequisite: CTRP 047 C.

Term hours: 36 lecture and 54 laboratory TBA. This course offers practical work experience in approved court and deposition proceedings. Internship will be scheduled during the semester, depending on available court and deposition openings. This course fulfills partial requirements of the Court Reporter's Board. Court reporting internships are unpaid. There will be 50 hours in the courtroom or in deposition proceedings, plus 10 hours of observation.

CTRP 082 C Computer Aided Transcription: ProCAT 1 Unit

Prerequisite: Students must have completed a CAT (Computer-Aided Transcription) dictionary.

Term hours: 18 lecture and 54 laboratory TBA. This course uses computer-based instruction as well as hands-on applications to introduce the court reporting student to ProCAT Computer Aided Transcription software.

CTRP 083 C Computer Aided Transcription - Stenograph 2 Units

Term hours: 18 lecture and 54 laboratory. This course uses computer based instruction as well as hands-on applications to introduce the court reporting student to Stenograph Computer-Aided Transcription software.

CTRP 084 C Computer Aided Transcription - Eclipse 2 Units

Term hours: 18 lecture and 54 laboratory. This course uses computer-based instruction as well as hands-on applications to introduce the court reporting student to ECLIPSE Computer-Aided Transcription software.

CTRP 085 C Computer Aided Transcription - Dictionary Building 2 Units

Term hours: 18 lecture and 54 laboratory. This course will enable court reporting students to start building their personal dictionary using one of several CAT (Computer Aided Transcription) software systems.

CTRP 086 C Internship - Proofreading 1.5 Units

Term hours: 18 lecture and 27 laboratory TBA. This course offers practical work experience in proofreading in order to prepare court, deposition, and other legal documents. Internship will be scheduled within the court reporting community. Internships may be paid or unpaid. There will be 30 hours of internship required.

CTRP 087 C Internship - Hearing Reporter 3 Units

Term hours: 36 lecture and 54 laboratory TBA. This course offers practical work experience in the field of hearing reporting. Students will work in the field taking hearings, meetings, conferences, seminars, and workman's compensation proceedings. Internships may be paid or unpaid. There will be 50 hours of internship, plus 10 hours of observation.

CTRP 088 C Internship - Captioning 3 Units

Term hours: 36 lecture and 54 laboratory TBA. This course offers practical work experience in the field of captioning, both on-line and off-line. Internship will be scheduled during the semester at various sites, including on-campus opportunities for development and perfection of captioning skills. A 15,000 word CAT dictionary is necessary to complete captioning projects. Internships may be paid or unpaid. There will be 50 hours of internship, plus 10 hours of observation.

CTRP 089 C Court/Conference Reporting: Literary II .5 to 3 Units

Term hours: 9-36 lecture and 27-54 laboratory. This course is designed to prepare the student to record a variety of literary dictation material at speeds ranging from 140 to 180 wpm. Students will be introduced to a broad spectrum of vocabulary with special emphasis on topics that will lead to a career in Communication Access Realtime Translation (CART) reporting. May be taken for credit 4 times. Open Entry/Open Exit. Pass/No Pass/Letter Grade Option.

CTRP 090 C Court/Conference Reporting: Literary 1 to 3 Units

Term hours: 18-36 lecture and 18-54 laboratory depending on units attempted. This course is designed to prepare the student to record a variety of literary dictation material at speeds ranging from 110 to 150 wpm. Students will be introduced to a broad spectrum of vocabulary designed to prepare them for convention reporting, hearing reporting, steno interpreting, and other alternative careers. May be taken for credit 4 times. Open Entry/Open Exit.

CTRP 091 C Advanced Dictionary Build 2 Units

Term hours: 18 lecture and 54 laboratory. This course is designed for court reporting students and captionists in order to further develop, modify, and refine their personal dictionary using one of several Computer Aided Transcription software systems.

CTRP 092 C Realtime Writing Concepts 2 Units

Term hours: 18 lecture and 54 laboratory. A programmed approach is used with guided instructions to introduce court reporting students to realtime writing. Students will use their completed electronic dictionary and the appropriate software with which their electronic dictionary is compatible. Students will use hands-on application to write various exercises covering a variety of concepts in realtime. \$3.00 Materials Fee - Payable at Registration.

CTRP 093 C Information Technology-CTRP 2 Units

Term hours: 36 lecture. This course is designed to introduce students to court reporting information technology, hardware technology, software applications, research links, auxiliary equipment, and CAT industry requirements. Pass/No Pass/Letter Grade Option.

CTRP 094 C Expert Testimony-Professional Reporter 2 Units

Term hours: 36 lecture. This class is designed for students and reporters to further develop dictionary refinement and writing skills in realtime. Students must furnish a steno machine, a lap top computer, and other related court reporting supplies.

CTRP 095 C Realtime Writing-Professional Reporter 2 Units

Term hours: 36 lecture. This class is an advanced realtime writing class designed for students and reporters who studied a non-compatible computer theory. The class focuses on realtime writing concepts and their application to dictionary development, conflict resolution, and non-translates. Students are required to furnish their own steno machine, lap top computer, and other related court reporting supplies.

CTRP 096 C Court/Conference Reporting: Literary III 1 to 3 Units

Prerequisite: CTRP 046 C or 160 wpm.

Term hours: 36 lecture and 54 laboratory depending on units attempted. This course is designed to prepare the student to record a variety of literary dictation material at speeds ranging from 180 to 220 wpm. Students will be introduced to a broad spectrum of vocabulary designed to prepare them for convention reporting, hearing reporting, steno interpreting, and closed captioning. May be taken for credit 4 times. Open Entry/Open Exit. Pass/No Pass/Letter Grade Option.

CTRP 097 C Internship - Scoping and Editing 1.5 Units

Term hours: 18 lecture and 27 laboratory TBA. This course offers practical work experience in scoping/editing in order to prepare court, deposition, and other legal documents. Internship will be scheduled with members of the court reporting community. Internships may be paid or unpaid. There will be 30 hours of internship required.

CTRP 098 C Court Reporting Seminar**.5 to 12 Units***Prerequisite: May be required.**Corequisite: May be required.**Advisory: May be required.*

Term hours: 0-216 lecture and 0-1296 laboratory depending on units attempted. This course will utilize a lecture and/or laboratory approach for students enrolled in the Court Reporting Program to increase their knowledge in applied areas. A variety of classes will be offered to increase the student's knowledge of the court reporting profession by updating content on recent changes and requirements and by preparing for new trends in court reporting. May be taken for credit 1-4 times. Pass/No Pass or Pass/No Pass/Letter Grade Option or Standard Letter Grade. Fees may be required—Payable at Registration.

CTRP 099 C Court Reporting: Independent Study .5 to 2 Units*Prerequisite: Approved Independent Study Learning Contract.*

Term hours: The number of class hours or activities per week will be determined by the scope of the topic. The instructor will devise learning strategies to be followed by the student. This course is designed for students who wish to gain further experience, knowledge, or expertise in applied areas of court reporting. Students must obtain permission from the program coordinator to be enrolled in this class. This course does not meet the requirements of the Court Reporting Certificate. This course may be used to fulfill hour requirements as mandated by the Court Reporter's Board. May be taken for credit 4 times. Pass/No Pass only.

Dance

Division of Fine Arts*Division Dean* — Katy Realista*Faculty*

Maha Afra

Erin Landry

Counselors

Renay Laguana-Ferinac

Renee Ssensalo

PROGRAM LEARNING OUTCOMES (PLOs)**Dance Department**

- Given a dance performance or teaching setting, students will be able to demonstrate knowledge of various dance techniques, choreography, performance and history of dance forms.
- Given a dance performance setting, students will be able to communicate dramatic and emotional content through choreography and dance.
- Given a dance performance students will be able to analyze dance works for their historical origins and choreographic technique.

Course Repeatability Limitations

Effective 2013, most active participatory courses in Art, Dance, Theater, Music, and Kinesiology/Physical Education are no longer repeatable. The courses in the table below are related in content and therefore have been identified in distinct “family” groupings in which students are limited to a maximum of 4 course enrollments per family (withdrawals and substandard grades will be counted towards the 4 enrollment maximum). Note: Exceptions for courses still designated as repeatable are indicated in course descriptions of the college catalog and class schedules with the statement, “May be taken for credit ____ times.” If students are majoring in any of these disciplines, they are advised to see their counselor to discuss options.

| DISCIPLINE | FAMILY/RELATED COURSES | COURSES RELATED IN CONTENT | LIMITATIONS |
|-------------------------|---|---------------------------------|--|
| Dance | Ballet | DANC 105 C, 106 C, 116 C | Students are limited to four (4) semester enrollments — in Active Participatory courses — whether in a single course or in a combination of courses grouped within a family. All enrollments in courses (including enrollments in the same repeatable course) within a family count toward the maximum enrollment limitation of four (4) semester enrollments. This includes evaluative (A, B, C, D, F, P, NP) and non-evaluative (I, IP, RD, and W) grades earned. All letter grades received will be counted in GPA. |
| | Modern | DANC 107 C, 108 C, 117 C | |
| | Jazz | DANC 111 C, 112 C | |
| | Tap | DANC 113 C, 114 C | |
| | Performance | DANC 141 C, 142 C, 143 C, 144 C | |
| Dance Exceptions | Courses Maintaining Repeatability CSU, UC Required courses 1 Plus 3 Repeats | DANC 205 C — Ensemble | |

ASSOCIATE IN ARTS DEGREE

DANCE

Program Code: 1A03781

Students will receive a well-rounded dance education that will prepare them to transfer as dance majors or to teach, choreograph, and perform at various community and private venues.

To earn an Associate Degree students must complete: (1) all major course requirements with a minimum grade of “C”; (2) 25 units of General Education Graduation Requirements; (3) the cultural diversity and reading requirements; (4) any elective courses to complete a minimum of 60 units; and, (5) have a minimum GPA of 2.0. At least 50% of all major course work must be completed at Cypress College. Courses that fulfill major requirements for an Associate Degree at Cypress College might not be the same as those required for completing the major at a transfer institution offering a Baccalaureate Degree. For information on specific university requirements, please consult with your counselor, or visit the Transfer Center.

| Required Courses | Units |
|---|----------------|
| DANC 101 C Multicultural Dance in the US | 3 |
| DANC 105 C Ballet I | 1.5 |
| DANC 106 C Ballet II | 2 |
| DANC 107 C Modern Dance I | 1.5 |
| DANC 108 C Modern Dance II | 1.5 |
| DANC 111 C Jazz Dance I | 1.5 |
| DANC 113 C Tap Dance I | 1 |
| DANC 112 C Jazz Dance II | 2 |
| or | |
| DANC 215 C Commercial Dance | (2) |
| DANC 202 C Elements of Choreography | 2 |
| DANC 141 C Performance Class I | 3 |
| DANC 214 C Dance Repertory | 3 |
| Select 2 courses from the following: | Units |
| DANC 100 C Intro to Dance Appreciation | 3 |
| DANC 109 C Dance Improvisation | 1 |
| DANC 114 C Tap Dance II | 2 |
| DANC 124 C Partnering | 1 |
| DANC 208 C Pointe Class | 1 |
| Select 3 courses from the following: | Units |
| DANC 115 C Hip Hop Dance | 1 |
| DANC 130 C Afro-Caribbean Dance | 1 |
| DANC 131 C Ballet Folklorico | 1–2 |
| DANC 132 C Flamenco Dance | 1 |
| DANC 133 C Dance of Andalusia | 1.5 |
| DANC 136 C Middle Eastern Dance | 1 |
| DANC 137 C Latin and Swing Dance | 1 |
| DANC 139 C Ballroom I | 1 |
| Select 2–3 units from the following: | Units |
| THEA 140 C Introduction to Theater Design | 3 |
| or | |
| THEA 145 C Fundamentals of Costume Design | (3) |
| THEA 142 C Theater Sound and Recording | 2 |
| or | |
| MUS 124 C Recording Studio I | (3) |
| THEA 144 C Lighting Design Fundamentals | 3 |
| Total Units Required | 29–34.5 |

DANCE TEACHING CERTIFICATE

Program Code: 1C12959

This program is designed to prepare the student to teach dance at private dance studios and community centers.

To earn a certificate, students must complete the required courses as listed with a minimum grade of “C.” At least 50% of all course work must be completed at Cypress College.

Required courses are listed in numeric sequence:

| Course # | Title | Units |
|-----------------|------------------------------|--------------|
| DANC 106 C | Ballet II | 2 |
| DANC 108 C | Modern Dance II | 2 |
| DANC 109 C | Dance Improvisation | 2 |
| | or | |
| DANC 202 C | Elements of Choreography | (2) |
| DANC 116 C | Ballet III | 2 |
| DANC 117 C | Modern Dance III | 2 |
| DANC 230 C | Dance Teaching Methodologies | 3 |

And an additional 5 units from the following:

| Course # | Title | Units |
|-----------------|------------------------------------|--------------|
| DANC 100 C | Introduction to Dance Appreciation | 3 |
| DANC 102 C | Pilates Mat Work | 1 |
| DANC 111 C | Jazz Dance I | 2 |
| | or | |
| DANC 112 C | Jazz Dance II | (2) |
| DANC 113 C | Tap Dance I | 1 |
| | or | |
| DANC 114 C | Tap Dance II | (1) |
| DANC 115 C | Hip Hop Dance | 1 |
| DANC 130 C | Afro-Caribbean Dance | 1 |
| DANC 136 C | Middle Eastern Dance | 1 |
| DANC 137 C | Latin and Swing Dance | 1 |
| DANC 139 C | Ballroom I | 1 |
| DANC 140 C | Summer Dance Festival I | 1.5–2 |
| DANC 141 C | Performance Class I | 2–3 |
| | or | |
| DANC 142 C | Performance Class II | (2–3) |
| | or | |
| DANC 203 C | Dance Production I | (0.5–2) |
| | or | |
| DANC 206 C | Dance Production II | (0.5–2) |
| | Total Units Required | 18 |

DANCE TRANSFER PROGRAM

Students should consult a counselor or www.assist.org for lower division major requirements for most California public universities. (See the Standard Definitions section of the catalog for a description of ASSIST.) Students transferring to an independent college/university should consult the catalog of the individual school and a counselor for lower division major requirements.

Dance (DANC)

DANC 100 C Introduction to Dance Appreciation 3 Units

Term hours: 36 lecture and 54 laboratory. Students will learn the basic dance technique of ballet, modern and jazz and a world dance form. Historical background will be provided. Dance concert admission may not exceed \$30.00 (UC/CSU, AA GE, CSU GE)

DANC 101 C Multicultural Dance in the US 3 Units*Advisory: Eligibility for ENGL 100 C.*

Term hours: 54 lecture. Social and theatrical dances of the U.S. today will be viewed and examined in terms of cultural influences, historical and social origins, and the functions they fulfill for individual artists, their cultures, and society in general. African American, Asian, Hispanic, European and Native American dances, choreographers and dancers will be studied. The class work will include readings, discussions, group projects, and analysis of dance performances on video and live theater. Attendance at a selected group of performances is required. Cost of dance concert admission will not exceed \$40.00. (UC/CSU, AA GE, CSU GE, IGETC, CUL DIV)

DANC 102 C Pilates Mat Work 1 Unit

Term hours: 54 laboratory. This class is designed to prepare a student mentally and physically for dance. Students will learn Pilates floor mat exercises and a floor barre to increase flexibility, strength, body alignment with emphasis on strengthening the core muscle groups. Dance Concert admission may not exceed \$30. Pass/No Pass/Letter Grade Option. (UC Credit Limitation/CSU)

DANC 105 C Ballet I 2 Units

Term hours: 18 lecture and 54 laboratory. This course introduces the rudiments of classical ballet to the beginning dance student. The students will develop the strength and coordination to perform the technical skills of basic ballet through barre and center work and by learning simple movement combinations. Ballet terminology will be covered. Pass/No Pass/Letter Grade Option. Dance concert admission will not exceed \$30.00. (UC/CSU, AA GE, CSU GE)

DANC 106 C Ballet II 2 Units*Prerequisite: Audition - Demonstrated mastery of beginning level dance technique as provided by Title V.*

Term hours: 18 lecture and 54 laboratory. This class covers the rudiments of classical dance for the intermediate ballet student. The student will develop technical skills to perform intermediate level steps and combinations of movement. Classical dance terminology will be covered. Dance Concert admission will not exceed \$30. (UC/CSU, AA GE, CSU GE)

DANC 107 C Modern Dance I 2 Units

Term hours: lecture 18 and 54 laboratory. Using a variety of music styles, students will learn and create dances that dynamically convey thoughts, feelings and ideas. Participation develops an expressive movement vocabulary while building strength and coordination. Pass/No Pass/Letter Grade Option. Dance concert admission will not exceed \$30.00. (UC/CSU, AA GE, CSU GE)

DANC 108 C Modern Dance II 2 Units*Prerequisite: Audition - Demonstrated mastery of beginning level dance technique as provided by Title V.*

Term hours: 18 lecture and 54 laboratory. Using a variety of music styles, students will learn and create intermediate level dances that convey thoughts, feelings and ideas. Students will broaden their movement range and become more coordinated and dynamic as movers. Dance concert admission will not exceed \$30.00. (UC/CSU, AA GE, CSU GE)

DANC 109 C Dance Improvisation 2 Units

Term hours: lecture 18 and 54 laboratory. This course is designed to train the mind and body to respond and explore creative movement problems through improvisation. Choreographic concepts will be studied through improvisation. Pass/No Pass/Letter Grade Option. Dance Concert admission will not exceed \$30. (UC/CSU, CSU GE)

DANC 111 C Jazz Dance I 2 Units

Term hours: 18 lecture and 54 laboratory. Students will learn basic skills of jazz dance with emphasis on body alignment, strength and coordination. Pass/No Pass/Letter Grade Option. Dance Concert admission not to exceed \$30. (UC/CSU, AA GE, CSU GE)

DANC 112 C Jazz Dance II 2 Units*Prerequisite: Audition - demonstrated mastery of beginning level dance techniques as provided by Title V.*

Term hours: 18 lecture and 54 laboratory. Students will further develop their technical skills for jazz dance and learn faster, more complicated movement combinations appropriate for the intermediate dancer. Pass/No Pass/Letter Grade Option. Dance concert admission will not exceed \$30.00. (UC/CSU, AA GE, CSU GE)

DANC 113 C Tap Dance I 1 Unit

Term hours: 54 laboratory. Students will study basic tap dance technique and elementary tap dances. The class provides students with the opportunity to develop coordination, rhythm and performance skills for tap dance. Some history of tap will be included. Pass/No Pass/Letter Grade Option. Cost of dance concert admission will not exceed \$30.00. (UC/CSU, CSU GE)

DANC 114 C Tap Dance II 1 Unit*Prerequisite: Audition - demonstrated mastery of beginning level dance technique provided by Title V.*

Term hours: 54 laboratory. Students will develop skills in rhythm dancing by studying intermediate level movements and combinations with some provision for student composition of dance. Performance skills will be included. Pass/No Pass/Letter Grade Option. Dance Concert admission will not exceed \$30.00. (UC/CSU, CSU GE)

DANC 115 C Hip Hop Dance 1 Unit

Term hours: 54 laboratory. Students will learn various forms of beginning hip-hop dance, including pop and lock, hip-hop funk, syncopations and rhythms. A basic history of hip-hop culture will be discussed. Pass/No Pass/Letter Grade Option. Dance concert admission will not exceed \$30.00. (UC/CSU, CSU GE)

DANC 116 C Ballet III 2 Units*Prerequisite: Audition - demonstrated mastery of beginning level dance technique as provided by Title V.*

Term hours: 18 lecture and 54 laboratory. Students will learn the advanced ballet technique. The class may cover the advanced ballet technique on flat and pointe and may include partner work. Dance Concert admission will not exceed \$30.00. Pass/No Pass/Letter Grade Option. (UC/CSU, CSU GE)

DANC 117 C Modern Dance III 2 Units*Prerequisite: Audition - demonstrate mastery of beginning/intermediate level dance technique.*

Term hours: 18 lecture and 54 laboratory. The course is designed for students with knowledge of intermediate level modern dance technique. Students will learn advanced modern dance technique that may include partnering. Dance Concert admission fees will not exceed \$30.00. Pass/No Pass/Letter Grade Option. (UC/CSU, CSU GE)

DANC 130 C Afro-Caribbean Dance 1 Unit

Term hours: 54 laboratory. Students will learn the dance styles and rhythms of African and Caribbean cultures including dances from West Africa, Brazil, Trinidad, Haiti, Bahia, Cuba, and the Dominican Republic. Dance as an inseparable part of the culture will be discussed. Pass/No Pass/Letter Grade Option. Dance concert admission not to exceed \$30.00. (UC/CSU, CSU GE)

DANC 132 C Flamenco Dance 1 Unit

Term hours: 54 laboratory. Students will study basic Flamenco Dance technique and learn movement combinations and the cultural aspect of the dance. The class provides students with the opportunity to develop coordination, rhythm, and performance skills for Flamenco Dance. Some history of Flamenco will be included. Pass/No Pass/Letter Grade Option. Dance concert admission not to exceed \$30.00. (UC/CSU, CSU GE)

DANC 136 C Middle Eastern Dance 1 Unit

Term hours: 54 laboratory. Students will learn the social and stage dances from the Near and Middle East. Course work includes styling, veil work, cymbal playing, improvisation, Dabke, fusion forms, vocabulary and cultural background of the dances. Pass/No Pass/Letter Grade Option. Dance concert admission not to exceed \$30.00. (UC/CSU, CSU GE)

DANC 137 C Latin and Swing Dance 1 Unit

Term hours: 54 laboratory. Students will learn various Latin and swing dance forms such as east and west coast swing, salsa, cha-cha, and meringue. The course will focus on learning the choreography in each style while developing coordination, partnering and performances skills. Individual choreography will enhance the students' knowledge of each dance forms as well as encourage creativity. Pass/No Pass/Letter Grade Option. Dance Concert admission not to exceed \$30.00. (UC/CSU, CSU GE)

DANC 139 C Ballroom I 1 Unit

Term hours: 54 laboratory. This course gives students the opportunity to learn various ballroom dances. Examples of dance forms that may be included are Waltz, Fox Trot, American Tango and Argentine Tango. The course will focus on learning International and American smooth styles of dance. The students will develop coordination skills and knowledge of each dance form. Cost of Dance Concert admission will not exceed \$30.00. (UC/CSU, CSU GE)

DANC 140 C Summer Dance Festival I 1.5 to 2 Units

Prerequisite: Audition.

Term hours: 81-108 laboratory TBA depending on units attempted. The Summer Dance Festival is designed to give both high school and college students the opportunity for intensive study of a variety of dance styles by taking technique classes while rehearsing choreography of faculty and students. All phases of the dance concert process from audition to rehearsal to backstage preparation will be covered. (UC/CSU)

DANC 141 C Performance Class I 2 to 3 Units

Formerly DANC 204 C

Prerequisite: Audition.

Advisory: DANC 203 C, THEA 149 C, or one from THEA 140 C - THEA 147 C.
Term hours: 144 - 216 laboratory. This course provides the experience of learning and performing choreographic works of faculty, students and guest artists. All phases of the performance process from audition to rehearsal to backstage preparation will be covered. Dance concert admission may not exceed \$30. (UC/CSU)

DANC 142 C Performance Class II 2 to 3 Units

Prerequisite: Audition.

Advisory: THEA 149 C, THEA 150 C, THEA 151 C, THEA 152 C, DANC 203 C or one from THEA 140 C - THEA 147 C.

Term hours: 144-216 laboratory depending on units attempted. This course concentrates on training students in the intermediate skills required for performing choreographic works of faculty, students and guest artists. All phases of the performance process from audition to rehearsal to backstage preparation will be covered. Dance concert admission may not exceed \$30. (UC/CSU)

DANC 143 C Performance Class III 2 to 3 Units

Prerequisite: Audition.

Advisory: THEA 149 C, THEA 150 C, THEA 151 C, THEA 152 C, DANC 203 C or one from THEA 140 C - THEA 147 C.

Term hours: 128-216 laboratory depending on units attempted. This course concentrates on training students in the advanced skills required for performing choreographic works of faculty, students and guest artists. All phases of the performance process from audition to rehearsal to backstage preparation will be covered. Dance concert admission may not exceed \$30. (UC/CSU)

DANC 144 C Performance Class IV 2 to 3 Units

Prerequisite: Audition.

Advisory: THEA 149 C, THEA 150 C, THEA 151 C, THEA 152 C, DANC 203 C or one from THEA 140 C - THEA 147 C.

Term hours: 128-216 laboratory depending on units attempted. This course concentrates on training students in the advanced skills required for performing and taking leadership roles in different aspects of the choreographic process of faculty, students and guest artists. All phases of the performance process from audition to rehearsal to backstage preparation will be covered. Dance concert admission may not exceed \$30. (UC/CSU)

DANC 145 C Summer Dance Festival II 1.5 to 2 Units

Prerequisite: Audition.

Term hours: 81-108 laboratory. The Summer Dance Festival II is designed to give both high school and college students the opportunity for intensive study of a variety of dance styles by taking intermediate technique classes while rehearsing choreography of Guest Artists and/or student choreographers. All phases of dance performance techniques from audition to rehearsal to performance will be covered. Pass/No Pass/Letter Grade Option. (UC/CSU)

DANC 202 C Elements of Choreography 2 Units

Prerequisite: Demonstrated mastery of beginning level dance technique.

Term hours: 36 lecture and 18 laboratory. Students will study the theories and practices involved in basic dance composition. Methodologies will include elements of shape, space time, music, topics and other theories and dance styles that involve the creation of a dance. Cost of dance concert admission will not exceed \$30.00. (UC/CSU)

DANC 203 C Dance Production I .5 to 2 Units

Term hours: 27-108 laboratory TBA depending on units attempted. This course offers practical experience in the technical aspects of dance production including costume design, set design, makeup, lighting, sound production, and publicity. (UC/CSU)

DANC 205 C Dance Ensemble 1 to 2 Units

Prerequisite: Audition.

Term hours: 54-108 laboratory depending on units attempted. Theater and dance students with intermediate to advanced skill levels will develop their performing and choreographic skills, perform at K-12 schools, community events, American Dance Festival and other dance festivals. May be taken for credit 4 times. (UC/CSU, CSU GE)

DANC 206 C Dance Production II .5 to 2 Units

Prerequisite: Audition.

Term hours: 27-108. This course offers practical experience in the technical aspects of running crew for dance production including costume design, set design, makeup, lighting, and sound production. Pass/No Pass/Letter Grade Option. (UC/CSU)

DANC 230 C Dance Teaching Methodologies 3 Units

Prerequisite: Audition.

Term hours: 36 lecture and 36 laboratory. Students will learn the appropriate teaching methodologies that can be applied in different instructional venues: schools, colleges and private studios, to name a few. Subject matter will include theoretical and practical applications of dance pedagogy. Cost of Dance Concert Admission not to exceed \$30.00. (CSU)

DANC 296 C Dance Open Laboratory .5 to 3 Units

Term hours: 27-162 laboratory depending on units attempted. This is an open entry/open exit class for students to obtain production experience associated with dance concert through performing, choreographing, technical work, management, and publicity. May be taken for credit 4 times. Open Entry/Open Exit. Concert admission cost may not exceed \$30.00. (UC Credit Limitation/CSU)

DANC 298 C Dance Seminar**.5 to 12 Units***Prerequisite: May be required.**Corequisite: May be required.**Advisory: May be required.*

Term hours: 0-216 lecture and/or 0-864 laboratory depending on units attempted. This seminar provides the opportunity to study new dance styles or a variety of other subject matters related to dance that are not included in present curriculum. May be taken for credit 1-4 times. Pass/No Pass or Pass/No Pass/Letter Grade Option or Standard Letter Grade. Fees may be required—Payable at Registration. (UC Credit Limitation/CSU)

DANC 299 C Dance Independent Study**.5 to 2 Units***Prerequisite: Approved Independent Study Learning Contract.*

Term hours: 18-72 for maximum credit. This course is for advanced students who wish to increase their knowledge of dance and/or performance through individual study or research. Unit credit may range from one-half to two units in any given semester. May be taken for credit 4 times. (UC Credit Limitation/CSU)

Dental Assisting

Division of Health Science

Division Dean — Rebecca Gomez, Interim

Faculty

Elizabeth Pacheco

Joel Silva

Counselors

Kelly Carter

Denise Vo

Doreen Villaseñor

PROGRAM LEARNING OUTCOMES (PLOs)

Dental Assisting

A student who completes the Dental Assisting program will be able to:

- Demonstrate the academic knowledge, skills, and competencies necessary to qualify for both the National Certification Exam and the California State Registered Dental Assistant Exam.
- Demonstrate the knowledge necessary for the ethical, legal and competent practice of dental assisting.
- Perform the functions approved by the California Dental Practice Act for a Dental Assistant and a Registered Dental Assistant, including infection control, with competence and judgment.
- Demonstrate clinical competency in dental radiology, coronal polish and dental sealants.
- Be prepared for employment as a dental assistant and as an integral member of the dental team.

PROGRAM DESCRIPTION

The Dental Assisting Program is a two-semester program that includes patient care experiences in a fully equipped on-site facility, with students assigned to clinics or dental offices for their clinical externship experiences. Course content provides the academic knowledge necessary for the competent practice of dental assisting and registered dental assisting.

The Cypress College Dental Assisting program is accredited by the Commission on Dental Accreditation and has been granted the accreditation status of Approval without reporting requirements. The Commission is a specialized accrediting body recognized by the Commission on Recognition of Postsecondary Accreditation and by the United States Department of Education. The Cypress College Dental Assisting Program is also accredited by the Dental Board of California, the Accrediting body for the dental professionals (Auxiliaries) in California through the Department of Consumer Affairs.

At the completion of the program the student will have satisfied the requirements set forth by the Dental Board of California to be eligible for the California Registered Dental Assistant (RDA) examination and the National Certification Examination for Dental Assistants. These requirements include satisfactory completion of course work in Radiation Safety, Coronal Polish, Dental Sealants, Infection Control, the Dental Practice Act, CPR, and all the duties for the Dental Assistant and Registered Dental Assistant. Upon satisfactory completion of the Registered Dental Assistant examination, the student will be licensed to perform all functions set forth in the Dental Practice Act by the Dental Board of California.

PROGRAM GOALS

The goal of the Dental Assisting Program is to provide the student with the educational opportunity to attain the academic knowledge and competence necessary to qualify for both the National Certification Examination and the California State Registered Dental Assistant Examination, and to prepare the student for dental assisting entry-level employment as an integral member of the dental health team.

PROGRAM OBJECTIVES:

1. To provide a dental assisting program to meet challenges presented by demographic changes of the current decade.
2. To promote a dental assisting curriculum that helps build student's educational and career goals in a success-oriented learning environment.
3. To provide students with the academic resources and clinical experiences to perform the functions approved by the California Dental Practice Act for a Dental Assistant and a Registered Dental Assistant with competence and judgment.
4. To provide students with academic knowledge and clinical skills in the Dental Practice Act, infection control and CPR.
5. To prepare the student to qualify for certification in Radiology Safety, Coronal Polishing and Dental Sealants.
6. To maintain a positive communication network between the advisory committee, dental community, and dental assisting program alumni.
7. To create a safe learning environment in compliance with federal and California state standards and regulations.

MINIMUM STANDARDS

1. Eligibility for admission to Cypress College.
2. High School graduation, or passing of the General Education Development (GED) or high school proficiency test, or an Associate's degree or higher from a regionally accredited college/university.
3. Evidence of good physical and mental health as determined by medical examination upon admission to the program and prior to enrollment.
4. Completion of ENGL 058 C/ESL 185 C or a comparable course, with grade of "C" or better, or submission of test scores that indicate eligibility for ENGL 060 C/ESL 186 C.

APPLICATION PROCEDURES

1. Meet with a counselor to determine fulfillment of the English requirements. Examples of ways to meet these requirements include taking the English assessment test at Cypress or another college and scoring into ENGL 060 C or ESL 186 C, or completing ENGL 058 C or ESL 185 C at Cypress or a comparable course at another college, with a grade of "C" or better.
2. Applications must be completed **online** starting the month of **February**. Applications will be accepted until the program is full or the fall semester begins. Please see the **Health Science Application link** on the Dental Assisting home page <http://www.CypressCollege.edu/da>
3. Enrollment is limited to the first 24 qualified applicants.

SELECTION PROCEDURES

Qualified applicants will be accepted into the program first come first serve based on the date of a completed Dental Assisting application with supporting documents, which have been received and evaluated.

ASSOCIATE IN SCIENCE DEGREE

DENTAL ASSISTING **Program Code: 1S03786**

This program is designed to enable a student to receive a Dental Assisting Associate in Science Degree. To earn an Associate Degree students must complete all graduation requirements to include: (1) all major course requirements with a "C" or better; (2) 25 units of General Education Graduation Requirements; (3) the cultural diversity and reading requirements; (4) any elective courses to complete a minimum of 60 units; and, (5) have a minimum GPA of 2.0. At least 50% of all major course work must be completed at Cypress College.

Required Courses are listed in suggested sequence. The following courses must be completed with a minimum grade of "C" to continue in the program.

| Course # | Title | Units |
|----------------------|-----------------------------------|-----------|
| FALL SEMESTER | | |
| DA 016 C | Dental Materials | 3 |
| DA 061 C | Oral Anatomy/Dental Assisting | 3 |
| DA 062 C | Preventive Dental Health - Basics | 3 |
| DA 063 C | Chairside Assisting I | 3 |
| DA 065 C | Radiology/Dental Assisting | 3 |
| DA 066 C | Clinical Dental Radiology | 1 |
| | | 16 |

SPRING SEMESTER

| | | |
|-----------------------------|--------------------------|-----------|
| DA 058 C | Clinical Externship I | 2 |
| DA 059 C | Clinical Externship II | 3.5 |
| DA 067 C | Dental Specialties | 3 |
| DA 068 C | Chairside Assisting II | 3 |
| DA 069 C | Clinical Externship III | 2.5 |
| DA 070 C | Dental Office Procedures | 2 |
| | | 16 |
| Total Units Required | | 32 |

All General Education units may be taken either prior to enrollment in the program or at the completion of the Certificate Program.

DENTAL ASSISTING CERTIFICATE

Program Code: 1C21117

This program is designed to enable a student to receive a certificate in Dental Assisting. To earn a certificate, students must complete all required course work as listed with a minimum grade of "C." At Least 50% of all course work must be completed at Cypress College.

| Course # | Title | Units |
|-----------------------------|-----------------------------------|-----------|
| FALL SEMESTER | | |
| DA 016 C | Dental Materials | 3 |
| DA 061 C | Oral Anatomy/Dental Assisting | 3 |
| DA 062 C | Preventive Dental Health - Basics | 3 |
| DA 063 C | Chairside Assisting I | 3 |
| DA 065 C | Radiology/Dental Assisting | 3 |
| DA 066 C | Clinical Dental Radiology | 1 |
| SPRING SEMESTER | | |
| DA 058 C | Clinical Externship I | 2 |
| DA 059 C | Clinical Externship II | 3.5 |
| DA 067 C | Dental Specialties | 3 |
| DA 068 C | Chairside Assisting II | 3 |
| DA 069 C | Clinical Externship III | 2.5 |
| DA 070 C | Dental Office Procedures | 2 |
| Total Units Required | | 32 |

Dental Assisting (DA)

DA 016 C Dental Materials 3 Units

Prerequisite: Acceptance into the Dental Assisting Program.

Term hours: 36 lecture and 54 laboratory. A study of the structure, chemical and physical properties and manipulation of materials used in dentistry will be covered. Laboratory application of dental materials and the relationship of dental materials to the oral environment is included. Emphasis in this course is on specific materials and functions delegated to the registered dental assistant by the State of California. \$85.00 Material Fee-Payable at Registration.

DA 058 C Clinical Externship I 2 Units

Prerequisite: Acceptance in the Dental Assisting Program.

Term hours: 9 lecture and 72 laboratory. This is the first in a series of clinical externships. The emphasis is on the beginning level skills and training for the dental assistant. Dental Assisting students will complete clinical rotations in dental offices and/or schools of dentistry. A minimum of eight hours per week will be spent in the clinical setting.

DA 059 C Clinical Externship II 3.5 Units

Prerequisite: Enrollment in the Dental Assisting Program and successful completion of all first semester courses.

Term hours: 18 lecture and 144 laboratory. This is the second in a series of clinical externships. The emphasis is on advanced skills and training for the dental assistant. Dental Assisting students will complete clinical rotations in dental offices and/or schools of dentistry. A minimum of eight hours per week will be spent in the clinical setting.

DA 061 C Oral Anatomy/Dental Assisting 3 Units

Prerequisite: Acceptance into the Dental Assisting Program.

Term hours: 54 lecture. This course is a study in dental anatomy and physiology, embryology, head and neck, tooth morphology and histology, occlusion and malocclusion, innervations of the oral cavity essential to the proper care of patients during clinical treatment. Emphasis is placed on the proper identification of dental structures within the oral cavity, and the recognition of normal occlusion in contrast to malocclusion.

DA 062 C Preventive Dental Health-Basics 3 Units

Prerequisite: Acceptance in the Dental Assisting Program.

Term hours: 36 lecture and 54 laboratory. This course deals with the concepts of dental health and total patient care. This is accomplished by providing instruction and practice of oral hygiene, production of plaque (etiological factors and effective removal of), applied nutrition, and developing a patient education program. In addition, this course covers management of dental and medical emergencies, taking and evaluating a medical/dental history and systemic diseases with dental care implications, infection control, dental photography, and oral evacuation.

DA 063 C Chairside Assisting I 3 Units

Prerequisite: Acceptance into the Dental Assisting Program.

Term hours: 36 lecture and 54 laboratory. This course provides lecture and laboratory instruction in chairside assisting, including history of dentistry, the dental health team, pre-clinical knowledge and entry-level skills for the assistant, advancing to the application of theoretical knowledge, and principles of restorative dentistry. In addition, students will be provided with a thorough knowledge of infection control in the dental environment. Principles and fundamentals of infection control, clinical procedures, sterilization and disinfection will be covered. Content and skills will progress in relation to the complexity of the procedures as the student gains practical experience. \$90.00 Material Fee-Payable at Registration.

DA 065 C Radiology/Dental Assisting 3 Units

Prerequisite: Acceptance into the Dental Assisting program or practicing Dental Assistant enrolled in class to meet state certification.

Term hours: 36 lecture and 54 laboratory. This course covers the didactic, pre-clinical work on mannequins and clinical instruction on patients as required by the California State Practice Act in regard to radiation safety. Upon successful completion of the course, the student will be certified to take x-rays on patients in the dental office. The student will complete 72 (seventy-two) hours of instruction to meet state requirements. \$74.00 Material Fee-Payable at Registration.

DA 066 C Clinical Dental Radiology 1 Unit

Prerequisite: Enrollment in the Dental Assisting Program and successful completion of all first semester courses.

Term hours: 54 clinical laboratory. This course provides advanced clinical instruction on the exposure of intraoral and extraoral radiographs. The bisecting angle technique; paralleling technique; panelipse machine; and adjunct dental radiology aids will be utilized. Emphasis in this course is placed upon the student's performance and demonstrated ability to consistently produce diagnostic radiographs. \$69.00 Material Fee-Payable at Registration.

DA 067 C Dental Specialties 3 Units

Prerequisite: Enrollment in the Dental Assisting Program and successful completion of all first semester courses.

Term hours: 36 lecture and 54 laboratory. This course provides instruction in the principles and procedures to function in the specialty area of dentistry: orthodontics, periodontics, endodontics, pediatric dentistry, prosthodontics, and oral surgery. It also provides information and clinical practice in those functions legally delegated to the Dental Assistant and Registered Dental Assistant in the California Dental Practice Act. It includes rules and regulations implemented by the Board of Dental Examiners pertaining to licensure. \$107.00 Material Fee-Payable at Registration.

DA 068 C Chairside Assisting II 3 Units

Prerequisite: Enrollment in the Dental Assisting Program and successful completion of all first semester courses and/or an employed dental assistant.

Term hours: 36 lecture and 54 laboratory. This course provides instruction in the principles, instrumentation, and procedures to function as a Registered Dental Assistant according to the legal stipulation in the California Dental Practice Act and implemented by the Board of Dental Examiners.

DA 069 C Clinical Externship III 2.5 Units

Prerequisite: Enrollment in the Dental Assisting Program and successful completion of all first semester courses.

Term hours: 144 laboratory. This is the third in a series of clinical externships. The emphasis is on advanced skills and training for the dental assistant and registered dental assistant. Dental Assistant students will complete clinical rotations in dental offices and/or schools of dentistry. A minimum of eight hours per week will be spent in the clinical setting.

DA 070 C Dental Office Procedures 2 Units

Prerequisite: Enrollment in the Dental Assisting Program and successful completion of all first semester courses.

Term hours: 36 lecture. This course is designed to provide instruction, both didactic and practical application, in the skills and responsibilities of a dental administrative assistant. In addition, the students will be trained to use the Dentrix Dental Software program to become knowledgeable in all areas of practice management utilizing the computer. These areas include patient files, charting and treatment planning, appointment scheduling, reports and insurance claim processing. \$5.00 Material Fee-Payable at Registration.

DA 099 C Dental Assisting Independent Study .5 to 2 Units

Prerequisite: Approved Independent Study Learning Contract.

Term hours: Varying hours of scheduled conferences or clinics per week according to instructor. This course is designed for students with background/experience in Dental Assisting who wish to increase their knowledge and experience in applied areas. Students will participate in independent study on assigned areas under staff supervision. May be taken for credit 4 times. Pass/No Pass/Letter Grade Option.

Dental Hygiene

Division of Health Science

Division Dean — Rebecca Gomez, Interim

Faculty

Julia Cherney
Kendra Contreras
Roberta Lawrence
Diana Tira

Counselors

Kelly Carter
Denise Vo
Doreen Villaseñor

PROGRAM LEARNING OUTCOMES (PLOs)

Dental Hygiene

A student who completes the Dental Hygiene program will be able to:

- Gain the knowledge necessary for the ethical, legal, and competent practice of dental hygiene.
- Gain the knowledge for disease prevention and oral health promotion.
- Gain the knowledge that will allow for involvement in community projects.
- Gain the knowledge that will promote professional growth, development, and an appreciation for scholarly activity.
- Gain the knowledge to provide optimal patient care.
- Attain the knowledge, skills, and values necessary to qualify to take the examinations for licensure as a Registered Dental Hygienist, and a professional member of the allied health team.

ASSOCIATE IN SCIENCE DEGREE

DENTAL HYGIENE

Program Code: 1S03787

The Cypress College Dental Hygiene Program is accredited by the Commission on Dental Accreditation, and has been granted the Accreditation status of approval without reporting. The Commission is a specialized accrediting body recognized by the United States Department of Education and the Council on Higher Education Accreditation. This program offers a curriculum that provides the student with the appropriate academic instruction to achieve eligibility for the National Board of Dental Hygiene Examiners written examination, and the California State Board Examination for licensure as a Registered Dental Hygienist, qualifying the candidate as stipulated in the California Dental Practice Act.

To earn an Associate Degree students must complete all graduation requirements to include: (1) all major course requirements with a “C” or better; (2) 25 units of General Education Graduation Requirements with a “C” or better; (3) the cultural diversity and reading requirements with a “C” or better; (4) any elective courses to complete a minimum of 60 units; and, (5) have a minimum GPA of 2.0. At least 50% of all major course work must be completed at Cypress College.

PROGRAM GOAL

The goal of the Cypress College Dental Hygiene Program is to provide the student with the educational opportunity to attain the knowledge and skills necessary to qualify for licensure as a Registered Dental Hygienist, and a professional member of the allied health team.

PROGRAM OBJECTIVES

1. To educate dental hygiene students in the ethical, legal and competent practice of dental hygiene.
2. To educate dental hygiene students in the areas of disease prevention and oral health promotion.
3. To facilitate dental hygiene students involvement in community projects.
4. To promote professional growth, development, and an appreciation for scholarly activity.
5. To ensure the dental hygiene student provides optimal patient care.

MINIMUM STANDARDS FOR APPLICANTS

1. Eligibility for admission to Cypress College.
2. High school graduation or completion of the General Education Development (GED) test or passing of high school proficiency examination.
3. GPA of 2.5 or higher in all college work completed.
4. Evidence of good physical and mental health as determined by medical examination upon admission to the program and prior to enrollment.
5. Completion of specific science courses with a minimum of “C” grade and overall GPA of 3.0. See list below.
6. Completion of specific general education courses prior to application.

PREREQUISITES

The following courses must be completed with a minimum grade of “C” and an overall GPA of 2.5.

1. Science: All courses must be completed within five years of filing the initial application and with an overall GPA of 3.0. Four courses must be completed prior to application; the remainder must be completed no later than the end of the spring semester prior to enrollment in the fall program.

Required courses are listed in suggested sequence:

| Course # | Title | Units |
|------------|--|-------|
| CHEM 101 C | Chemistry for Health Science Majors I | 4 |
| CHEM 201 C | Chemistry for Health Science Majors II | 4 |
| BIOL 220 C | Medical Microbiology | 4 |
| BIOL 231 C | General Human Anatomy | 4 |
| BIOL 241 C | Human Physiology | 4 |
| HRC 100 C | Nutrition | 3 |

2. In addition a minimum of three courses of the following related courses must be completed prior to application. All courses must be completed by the end of the spring semester prior to fall enrollment into the program.

| | | |
|------------|----------------------------|---|
| PSY 101 C | Introduction to Psychology | 3 |
| SOC 101 C | Introduction to Sociology | 3 |
| COMM 100 C | Human Communication | 3 |
| ENGL 100 C | College Writing | 4 |
| | Cultural Diversity | 3 |

ADDITIONAL COURSES

The following courses are required for the Associate Degree and must be completed prior to the end of the program if an Associate Degree has not already been earned by the student:

| | | |
|------------|----------------------------------|---|
| MATH 040 C | Intermediate Algebra (or higher) | 4 |
| | Art | 3 |
| | Humanities | 3 |
| PE | Physical Education | 1 |
| | Reading Proficiency | 3 |
| | Cultural Diversity | 3 |

SELECTION PROCEDURE

Applications normally exceed capacity. Selection of applicants is based on accumulation of points. Criteria are available in the Health Science Counseling Office. Criteria are subject to change. It is the applicant's responsibility to verify that evidence of criteria is on file at Cypress College.

APPLICATION PROCEDURES

1. Applications must be completed **online** during the month of **February**. Please see the **Health Science Application link** on the Dental Hygiene home page.
2. Applicants must submit official transcripts (except Cypress and Fullerton Colleges) and signature page of application **in person** to the Health Science Applications office, Health Science Building, Cypress College, 9200 Valley View Street, Cypress, California 90630-5897 by **March 15**. Please bring photo identification.

DENTAL HYGIENE CURRICULUM

Dental Hygiene courses must be taken in a specific sequence. Students must obtain a minimum grade of "C" or better in all courses listed in the Dental Hygiene Curriculum to continue in the program. Refer to the General Education Requirement of the college to obtain an Associate Degree.

Upon completion of the Dental Hygiene curriculum listed below and the general education requirements, the student will be eligible for an Associate Degree from Cypress College. Those students who have previously earned an Associate in Science Degree or higher and have completed all the Cypress College Dental Hygiene curriculum requirements will be eligible for a Certificate in Dental Hygiene.

Required Courses are listed in specific sequence:

| Course # | Title | Units |
|-----------------------------|---------------------------------|-----------|
| SEMESTER 1 | | |
| DH 101 C | Dental Anatomy and Morphology | 2 |
| DH 104 C | Oral Health Assessment | 3 |
| DH 106 C | Radiology Technician-Hygienists | 3 |
| DH 109 C | Pre-Clinical Dental Hygiene | 5 |
| DH 205 C | Oral Embryology and Histology | 3 |
| Total Units Required | | 16 |
| SEMESTER 2 | | |
| DH 110 C | Clinical Dental Hygiene | 6 |
| DH 113 C | General and Oral Pathology | 2 |
| DH 116 C | Dental Materials/Hygienists | 2 |
| DH 125 C | Perio Pathology and Therapy | 2 |
| DH 212 C | Head and Neck Anatomy | 2 |
| Total Units Required | | 14 |

SEMESTER 3

| | | |
|----------|-------------------------------|-----|
| DH 220 C | Clinical Dental Hygiene | 6.5 |
| DH 240 C | Community Oral Health I | 2 |
| DH 250 C | Pharmacology | 2 |
| DH 255 C | Dental Anesthesiology | 3 |
| DH 260 C | Dental Care for Special Needs | 2 |

Total Units Required 15.5

SEMESTER 4

| | | |
|----------|----------------------------|---|
| DH 221 C | Clinical Dental Hygiene | 6 |
| DH 230 C | Dental Specialties | 2 |
| DH 241 C | Community Oral Health II | 2 |
| DH 245 C | Dental Jurisprudence | 2 |
| DH 248 C | Medical/Dental Emergencies | 1 |

Total Units Required 13

Program Total Units 58.5

Additional Recommended Course Work (not required)

| | | |
|----------|----------------------------------|------|
| DH 275 C | Clinical Dental Hygiene 1A | .5 |
| DH 276 C | Clinical Dental Hygiene 2A | .5 |
| DH 299 C | Dental Hygiene Independent Study | .5-2 |

DENTAL HYGIENE CERTIFICATE

Program Code: 1C21118

Students who have previously earned an Associate of Science or higher degree and have completed all the Cypress College Dental Hygiene curriculum requirements will be eligible for a Certificate in Dental Hygiene. To earn a certificate, students must complete the required courses as listed with a minimum grade of "C." At Least 50% of all course work must be completed at Cypress College.

PRE-DENTAL HYGIENE TRANSFER PROGRAM

Students should consult a counselor or www.assist.org for lower division major requirements for most California public universities. (See the Standard Definitions section of the catalog for a description of ASSIST.) Students transferring to an independent college/university should consult the catalog of the individual school and a counselor for lower division major requirements.

Dental Hygiene (DH)

DH 101 C Dental Anatomy and Morphology 2 Units

Prerequisite: Admission to and enrollment in the Dental Hygiene Program.
Term hours: 36 lecture. This course presents a study in dental anatomy, morphology, and occlusion essential to the proper care of patients during clinical treatment. An emphasis will be placed on the proper identification of oral and dental structures, the utilization of proper terminology, the recognition of normal occlusion in contrast to malocclusion and the clinical significance of temporomandibular joint dysfunction. (CSU)

DH 104 C Oral Health Assessment 3 Units

Prerequisite: Admission to and enrollment in the Dental Hygiene Program.
Term hours: 54 lecture. This course is a multifaceted course that presents foundation information skills for the beginning student clinician to utilize daily in direct patient care. Primarily, it is an introduction to the recognition, gathering and interpretation of assessment data as an aid to formulating checklist dental hygiene treatment plans. In addition, it provides the basics to dental disease prevention through the dissemination and application of existing dental health knowledge through chair side instruction. (CSU)

DH 106 C Radiology Technician-Hygienists 3 Units

Prerequisite: Admission to and enrollment in the Dental Hygiene Program.
Term hours: 36 lecture and 54 laboratory. This course for dental hygiene students includes didactic and preclinical instruction in the essentials of dental radiography. Lecture emphasizes the technical aspects of radiation production, protection against the hazards of radiation, and utilization of radiographs during patient care. The laboratory provides demonstrations and practical application in the fundamentals of intraoral and extraoral radiographic techniques, processing, mounting and identification of normal anatomical landmarks. \$123.00 Material Fee-Payable at Registration. (CSU)

DH 109 C Pre-Clinical Dental Hygiene 5 Units

Prerequisite: Admission to and enrollment in the Dental Hygiene Program.
Term hours: 54 lecture and 108 laboratory. This is the first in a series of four courses designed to prepare the student for clinical dental hygiene practice. Content emphasis includes bloodborne and infectious disease exposure, care and operation of dental equipment, identification, purpose and function of basic instrumentation skills, instrument sharpening, polishing agents and methods, topical fluoride application, entry level clinic forms and procedures, clinic duties, and clinical practice utilizing examination procedures and basic instrumentation techniques on student patient partners and periodontal typodonts/manikins. \$68.00 Material Fee-Payable at Registration. (CSU)

DH 110 C Clinical Dental Hygiene 6 Units

Prerequisite: Enrollment in the Dental Hygiene Program and successful completion of all first semester courses.
Term hours: 18 lecture and 54 laboratory and 216 clinic per week. This is the second in a series of four courses designed to prepare the student for clinical dental hygiene practice. Emphasis is placed on perfecting oral inspection and medical/dental health history documentation, and developing dental hygiene treatment plans. Additional course content includes: introduction to universal curette instrumentation and sharpening techniques, root debridement techniques, oral and subgingival irrigation, gingival curettage, introduction to ultrasonic instrumentation and air polishing. Clinical skills will be demonstrated and evaluated on clinical patients appointed in the Cypress College Dental Hygiene Clinic. (CSU)

DH 113 C General and Oral Pathology 2 Units

Prerequisite: Enrollment in the Dental Hygiene Program and successful completion of all first semester courses.
Term hours: 36 lecture. This course introduces students to concepts of oral pathology and specific pathologic processes, including inflammatory and immunologic defenses, as well as neoplastic, metabolic, inherited and developmental disturbances. A summary of each condition is presented and includes information to aid the Dental Hygienist in developing a clinically useful differential diagnosis. (CSU)

DH 115 C Nutrition for Dental Hygiene 2 Units

Prerequisite: Current enrollment in the Dental Hygiene Program and successful completion of first semester courses.
Term hours: 36 lecture. This course is designed to provide knowledge in nutrition and biochemistry. Instruction will emphasize the principles of nutrition, their application to dental health instruction, nutritional counseling, dental survey, and patient nutritional assessment. (CSU)

DH 116 C Dental Materials-Hygienists 2 Units

Prerequisite: Enrollment in the Dental Hygiene Program and successful completion of all first semester courses.
Term hours: 18 lecture and 54 laboratory. The structure, chemical and physical properties, and manipulation of materials used in dentistry will be covered. Laboratory application of dental materials and the relationship of dental materials to the oral environment is included. Emphasis will be placed on specific materials and functions delegated to the registered dental assistant and dental hygienist by the State of California. \$102.00 Material Fee-Payable at Registration. (CSU)

DH 125 C Perio Pathology and Therapy 2 Units

Prerequisite: Enrollment in the Dental Hygiene Program and successful completion of all first semester dental hygiene courses.
Term hours: 36 lecture. This course is designed to provide the dental hygiene student with current theory in periodontics. The healthy periodontium as well as the diseased states will be explored. New surgical concepts and techniques in periodontics will be discussed. The management of periodontics in clinical treatment will be emphasized. (CSU)

DH 205 C Oral Embryology and Histology 3 Units

Prerequisite: Admission to and enrollment in the Dental Hygiene Program.
Term hours: 36 lecture and 54 laboratory. This course is an introduction to the microscopic characteristics of the tissues, histology, and embryology of the head and neck with an emphasis of the structure of the oral cavity. (CSU)

DH 212 C Head and Neck Anatomy 2 Units

Prerequisite: Enrollment in the Dental Hygiene Program and successful completion of all first semester courses.
Term hours: 36 lecture. This course is a study of the gross and anatomical structures of the head and neck. The relationship and function of the organs of the head and neck in the human body are studied, with an emphasis on structures and innervations of the oral cavity. (CSU)

DH 220 C Clinical Dental Hygiene 6.5 Units

Prerequisite: Enrollment in the Dental Hygiene Program and successful completion of all second semester courses.
Term hours: 27 lecture and 288 laboratory. This is the third in a series of four courses designed to prepare the student for clinical dental hygiene practice. Lecture and clinical instruction will be applied by experience on clinical patients in the Cypress College Dental Hygiene facility and off campus clinical site, and/or an enriching facility. An emphasis will be placed on the assimilation and utilization of previous instruction and demonstration of progressive learning. This course also emphasizes the performance of those expanded duties in dental hygiene as allowed by the California State Dental Practice Act, Dental Hygiene Committee of California and the progressive development of professional and managerial skills. \$46.00 Materials Fee-Payable at Registration. (CSU)

DH 221 C Clinical Dental Hygiene 6 Units

Prerequisite: Enrollment in the Dental Hygiene program and successful completion of all third semester courses.
Term hours: 18 lecture and 288 laboratory. This is the final course in clinical dental hygiene designed to prepare the student for clinical dental hygiene practice and to provide students advanced instruction in patient care. Lecture and clinical instruction will be applied by clinical experience on clinical patients in the Cypress College Dental facility and off campus clinical site, and/or an enriching facility. An emphasis will be placed on: (1) periodontal therapy, (2) supportive periodontal treatment, (3) expanded and supportive periodontal treatment, (4) expanded and supportive procedures, (5) treatment planning, (6) organization and implementation of a Student Research presentation/Table Clinic, and (7) the completion and presentation of a Case Presentation of extensive and comprehensive dental hygiene treatment of a patient. (CSU)

DH 230 C Dental Specialties 2 Units

Prerequisite: Enrollment in the Dental Hygiene Program and successful completion of all third semester courses.
Term hours: 36 lecture. This is a study of the dental hygienist's role within the various dental practices. Each dental specialty practice is studied to establish a proper perspective of dental hygiene in relationship to dentistry and to have a greater comprehension of total patient care. (CSU)

DH 240 C Community Oral Health I 2 Units

Prerequisite: Enrollment in the Dental Hygiene program and successful completion of all second semester courses.

Term hours: 36 lecture. This is the first of two courses designed to provide the student with the knowledge and experience necessary to work within the community in the area of public health. Emphasis will be placed on the understanding of developing a community health project, use of statistics, and the development of teaching strategies for use in the classroom. Students are expected to work with target groups within the community. (CSU)

DH 241 C Community Oral Health II 2 Units

Prerequisite: Enrollment in the Dental Hygiene Program and successful completion of all third semester courses.

Term hours: 36 lecture. This course is the second of two courses in Community Oral Health to develop principles and practices of dental public health. Emphasis of instruction will be placed on community-wide problems such as water fluoridation and the delivery of care. Students will participate in target groups within the community. (CSU)

DH 245 C Dental Jurisprudence 2 Units

Prerequisite: Enrollment in the Dental Hygiene Program and successful completion of all third semester courses.

Term hours: 36 lecture. This course offers a study of the fundamental factors necessary to conduct a well-regulated practice based on sound dental management principles within the legal and ethical framework of the State Dental Practice Act. Emphasis is placed on the historical aspects of dental hygiene, the ethical and legal responsibilities of the dental hygienist, interpersonal relations among members of the dental team, and patient-office relationships. (CSU)

DH 248 C Medical/Dental Emergencies 1 Unit

Prerequisite: Enrollment in Dental Hygiene Program and successful completion of all third semester courses.

Term hours: 18 lecture. This course will provide the student with a consolidation of information concerning medical/life threatening situations within the dental care setting. Early recognition of clinical signs and symptoms and emergency treatment of the condition will be included in this course. (CSU)

DH 250 C Pharmacology 2 Units

Prerequisite: Enrollment in the Dental Hygiene Program and successful completion of all second semester courses.

Term hours: 36 lecture. This course includes the principles of drug interaction with living tissue (pharmacodynamics) and the time course of drugs within living organisms (pharmacokinetics); drug effects on the cardiovascular, autonomic, and central nervous systems; drug management of anxiety, pain and infection as related to dental practice and the harmful aspects of drugs (toxicology). (CSU)

DH 255 C Dental Anesthesiology 3 Units

Prerequisite: Enrollment in the Dental Hygiene Program and successful completion of all second semester courses.

Term hours: 36 lecture and 72 laboratory. This course includes the theory and techniques of administration of local anesthesia and sedation in dentistry as related to the California State Dental Practice Act and Dental Hygiene Committee of California. The student will administer local anesthesia and nitrous oxide-oxygen sedation in the clinical setting as a component of comprehensive patient care. (CSU)

DH 260 C Dental Care for Special Needs 2 Units

Prerequisite: Enrollment in the Dental Hygiene Program and successful completion of all second semester courses.

Term hours: 36 lecture. This course is designed to give the student a study in the needs of the medically compromised, or the mentally and physically challenged patient. Emphasis will be placed on therapeutic techniques in treating these special needs patients in a dental clinical situation. (CSU)

DH 275 C Clinical Dental Hygiene 1A .5 Units

Prerequisite: DH 110 C.

Term hours: 27 laboratory. This is a clinical course in dental hygiene designed to provide students advanced instruction in patient care. An emphasis will be placed on treatment planning, and clinical instrumentation. This course provides the student with 24 hours of clinical instruction. Pass/No Pass only. (CSU)

DH 276 C Clinical Dental Hygiene 2A .5 Units

Prerequisite: DH 221 C with a minimum grade of "C".

Term hours: 27 laboratory. This is a clinical course in dental hygiene designed to provide students advanced instruction in patient care. An emphasis will be placed on treatment planning, and advanced instrumentation for State Board Preparation. Pass/No Pass Only. (CSU)

DH 299 C Dental Hygiene Independent Study .5 to 2 Units

Prerequisite: Approved Independent Study Learning Contract.

Term hours: 9-36 lecture and/or 0-108 laboratory depending on units attempted. This course is designed for students enrolled in the Dental Hygiene Program who wish to increase their knowledge and experience in applied areas. Students will participate in independent study on assigned areas under staff supervision. May be taken for credit 3 times. Pass/No Pass/Letter Grade Option. (CSU)

Diagnostic Medical Sonography

Division of Health Science

Division Dean — Rebecca Gomez, Interim

Faculty

Nancy Corrales

Lynn Mitts

Counselors

Kelly Carter

Denise Vo

Doreen Villaseñor

PROGRAM LEARNING OUTCOMES (PLOs)

Diagnostic Medical Sonography Program Goals

1. Students will have the knowledge and skills to competently and safely perform sonography procedures.
2. Students will develop the skills necessary to communicate effectively.
3. Students will use critical thinking and problem solving skills.
4. Students will evaluate the importance of professional development and growth.
5. The program will provide the community with entry level sonographers for employment in the healthcare setting.

PROGRAM MISSION STATEMENT

The Cypress College Diagnostic Medical Sonography program provides a high quality education to prepare a diverse population of students with entry level skills needed to become competent and confident sonographers.

PROGRAM GOALS AND OBJECTIVES

1. Students will have the knowledge and skills to competently and safely perform sonography procedures.
2. Students will develop the skills necessary to communicate effectively.
3. Students will use critical thinking and problem solving skills.
4. Students will evaluate the importance of professional development and growth.
5. The program will provide the community with entry level sonographers for employment in the healthcare setting.
 - Program Effectiveness expected outcomes are:
 - a. Students will pass the national certification exam on the 1st attempt.
 - b. Students seeking employment will be gainfully employed within 6 months of graduation.
 - c. Students will complete the program.
 - d. Graduates will be satisfied with their education.
 - e. Employers will be satisfied with the performance of newly hired technologists.

After completing the clinical internship and receiving the completion certificate, the student will be eligible to apply for the certification examination administered by the American Registry of Diagnostic Medical Sonographers (ARDMS). The Diagnostic Medical Sonography program is accredited by the Joint Review Committee for Diagnostic Medical Sonographers (JRC-DMS) and the Commission on Accreditation of Allied Health Education Programs.

Joint Review Commission on Education in Diagnostic Medical Sonography (JRC-DMS)

6021 University Boulevard
 Suite 500
 Ellicott City, MD 21043
 phone: 443-973-3251
 fax: 866-738-3444
 web: www.jrcdms.org
 e-mail: mail@jrcdms.org

MINIMUM STANDARDS TO APPLY

1. Eligibility for admission to Cypress College.
2. High school diploma or GED test, or the high school proficiency examination.
3. Minimum age of 17 years. Must be 18 years old at the start of clinical training.
4. Present evidence of good physical and mental health, as determined by medical examination upon admission to program and prior to enrollment.
5. Overall GPA of 2.0 in all college classes taken.
6. Must have own transportation to all affiliated hospitals.
7. Eligibility for ENGL 100 C.
8. See "Prerequisites and Requirements" for specific course prerequisites needed to apply.

PREREQUISITES AND REQUIREMENTS

1. The following *Foundation* courses must be completed by the end of the spring semester with a minimum "C" grade in each course. Once a passing grade is achieved and program application requirements are met courses may not be repeated for a higher grade.

| Course # | PREREQUISITES Title | Units |
|------------|--|-------|
| RADT 142 C | Radiologic Electronics (*or any introduction or general physics course) | 4 |
| RADT 153 C | Radiography Patient Care | 3 |
| HS 145 C | Survey of Medical Terminology | 3 |
| HS 147 C | Survey of Disease | 3 |
| BIOL 210 C | Anatomy and Physiology | 5 |
| ENGL 100 C | College Writing | 4 |
| | or | |
| COMM 050 C | Effective Communication | (3) |
| | or | |
| COMM 100 C | Human Communication | (3) |
| MATH 040 C | Intermediate Algebra | 4 |
| CIS 111 C | Computer Information Systems | 3 |
| *DMS 060 C | Introduction to Sonography | 2 |

- *DMS 060 C must be completed in the Summer session prior to enrollment into the Fall Semester of the Sonography Program. This course is offered only to the accepted and alternate students who will start the program in the next fall semester.
2. Radiologic Technologists must present official transcripts to verify completion of foundation courses: California C.R.T. license; A.R.R.T. Registry.

APPLICATION AND SELECTION PROCEDURE

1. A separate application, in addition to the college application, is required for admission into the Diagnostic Medical Sonography Program.
2. Applications must be completed **online** during the month of **February**. Please see the **Health Science Application link** on the Diagnostic Medical Sonography home page.
3. Applicants must submit official transcripts (except Cypress and Fullerton Colleges), documents (AART, CRT, Certificate and signature page of application) **in person** to the Health Science Applications office, Health Science Building, Cypress College, 9200 Valley View Street, Cypress, California 90630-5897 by **March 15**. Please bring photo identification.
4. Practical Radiologic Technology years of experience must be verified by completion of the work experience form by the employer, if applicable.
5. An appointment with Health Science counselor or attendance at a program information meeting is recommended to discuss selection criteria and deadlines for application process. Selection criteria will award points to practical and formal radiologic technology experience as well as grade point average in program prerequisites. Selection criteria is subject to change.
6. Class enrollment is based on the number of approved clinical education centers available. Student capacity is also determined by the Joint Review Commission in Diagnostic Medical Sonographers.

ASSOCIATE IN SCIENCE DEGREE DIAGNOSTIC MEDICAL SONOGRAPHY

Program Code: 1S07840

The Department of Radiologic Technology will provide occupational training in Diagnostic Medical Sonography. The purpose of this instruction is to qualify the student for examination by the American Registry of Diagnostic Medical Sonography and to prepare the student for gainful employment in Diagnostic Medical Sonography.

To earn an Associate Degree students must complete: (1) all major course requirements with a minimum grade of "C"; (2) 25 units of General Education Graduation Requirements; (3) the cultural pluralism and reading requirements; (4) any elective courses to complete a minimum of 60 units; and (5) have a minimum GPA of 2.0. At least 50% of all major course work must be completed at Cypress College.

| Required courses: | Units |
|---|-----------|
| All courses of the Certificate Program | 53 |
| General Education Graduation Requirements | 25 |
| Total Units Required | 78 |

Note: All General Education Graduation Requirements units may be taken prior to enrollment in the program or at the completion of the Certificate Program.

REQUIREMENTS

| | | Units |
|-----------------------------|---------------------------|-----------|
| SEMESTER I | | |
| DMS 170 C | Sonography Physics | 3 |
| DMS 175 C | Abdomen Sonography | 4 |
| DMS 172 C | Sonography Externship | 5 |
| RADT 262 C* | Cross-Sectional Imaging | 1 |
| HS 165 C* | Ethical and Legal Issues | 1.5 |
| SEMESTER II | | |
| DMS 176 C | Pathology and Small Parts | 3 |
| DMS 186 C | Ob/Gyn Sonography | 4 |
| DMS 207 C | Clinical Education I | 10 |
| SUMMER INTERSESSION | | |
| DMS 188 C | Doppler Techniques | 1.5 |
| DMS 217 C | Clinical Education II | 7 |
| SEMESTER III | | |
| DMS 227 C | Clinical Training III | 11 |
| DMS 210 C | Review Seminar | 2 |
| Total Units Required | | 53 |

*May be taken prior to enrollment in the program.

DIAGNOSTIC MEDICAL SONOGRAPHY CERTIFICATE

Program Code: 1C21115

REQUIREMENTS

| | | Units |
|--------------------|---------------------------|-------|
| SEMESTER I | | |
| DMS 170 C | Sonography Physics | 3 |
| DMS 175 C | Abdomen Sonography | 4 |
| DMS 172 C | Sonography Externship | 5 |
| RADT 262 C* | Cross-Sectional Imaging | 1 |
| HS 165 C* | Ethical and Legal Issues | 1.5 |
| SEMESTER II | | |
| DMS 176 C | Pathology and Small Parts | 3 |
| DMS 186 C | Ob/Gyn Sonography | 4 |
| DMS 207 C | Clinical Education I | 10 |

| | SUMMER INTERSESSION | Units |
|-----------------------------|----------------------------|-----------|
| DMS 188 C | Doppler Techniques | 1.5 |
| DMS 217 C | Clinical Education II | 7 |
| SEMESTER III | | |
| DMS 227 C | Clinical Training III | 11 |
| DMS 210 C | Review Seminar | 2 |
| Total Units Required | | 53 |

*May be taken prior to enrollment in the program.

Diagnostic Medical Sonography (DMS)

DMS 060 C Introduction to Sonography 2 Units

Prerequisite: Satisfactory completion of RADT 142 C, RADT 153 C, HS 145 C, HS 147 C, BIOL 210 C, ENGL 100 C, MATH 040 C and CIS 111 C all with minimum grades of "C".

Term hours: 27 lecture and 27 laboratory. This course is designed for the student entering the sonography program. Basic sonography theory is taught with emphasis on sonographic terminology and equipment manipulation. Anatomy identification, scanning planes, transducer orientation, ergonomics, and scanning protocols are included. Non Degree Credit. \$14.00 Material Fee - Payable at Registration.

DMS 170 C Sonography Physics 3 Units

Formerly RADT 170 C and RADT 173 C

Prerequisite: Acceptance to the Diagnostic Medical Sonography Program.

Term hours: 54 lecture. This course will provide lecture and demonstrations covering the areas of acoustical physics, propagation principles, transducers, machine instrumentation, hemodynamics, harmonics, doppler principles, biological effects, artifacts, and quality control. (CSU)

DMS 172 C Sonography Externship 5 Units

Prerequisite: Admission into the Diagnostic Medical Sonography Program.

Term hours: 288 laboratory TBA. This course is designed to acclimate the sonography student to the hospital setting, sonography department, and the sonography profession. The student is expected to complete a minimum of 256 hours of clinical training at an assigned clinical facility. Topics include hospital orientation, HIPAA regulations, SDMS code of ethics, sonography ergonomics, and basic scanning techniques and protocols. (CSU)

DMS 175 C Abdomen Sonography 4 Units

Prerequisite: Acceptance to the Diagnostic Medical Sonography Program.

Term hours: 54 lecture and 27 laboratory. This course will provide a study of the clinical applications of abdomen sonography. It will include abdominal vasculature; liver; gallbladder and biliary system; pancreas; spleen; and kidneys. Interpretation of clinical laboratory tests, related clinical signs and symptoms, and normal and abnormal sonographic patterns will be discussed. This course includes a lab section on basic scanning techniques and protocol. (CSU)

DMS 176 C Pathology and Small Parts 3 Units

Prerequisite: DMS 175 C, RADT 262 C, DMS 170 C, DMS 172 C and HS 165 C with minimum grades of "C".

Corequisite: DMS 186 C and DMS 207 C.

Term hours: 54 lecture. This course will discuss the manifestations of abdominal pathology and disease conditions and their relevance to sonographic procedures including hemodynamic changes. The student will describe abdomen scanning techniques and procedures appropriate for the disease process. Normal anatomy, scanning technique, and pathology of small parts is included as well as neonatal imaging. The course will support the student in the clinical phase of sonographic training. Sonographic technique and actual pathologic cases will be discussed. (CSU)

DMS 186 C Ob/Gyn Sonography 4 Units

Prerequisite: DMS 170 C, DMS 172 C, and DMS 175 C with minimum grades of “C”.

Corequisite: Completion of or concurrent enrollment in DMS 176 C and DMS 207 C.

Term hours: 72 lecture. Obstetric/Gynecology sonography is a study of the pregnant and non-pregnant female reproductive system. This includes an assessment of fetal gestational age, fetal anatomy and pathology, as well as, associated maternal conditions. Gynecological sonography includes normal female anatomy along with pathological processes. Topics of discussion include related clinical symptoms, sonographic appearances, scanning techniques and protocols, and laboratory tests. This course includes a demonstration section on basic scanning techniques and protocol. (CSU)

DMS 188 C Doppler Techniques 1.5 Units

Prerequisite: DMS 176 C, DMS 186 C, and DMS 207 C with minimum grades of “C”.

Corequisite: DMS 217 C.

Term hours: 27 lecture. This course includes vascular scanning techniques related to carotid, venous, and arterial sonographic exams. (CSU)

DMS 207 C Clinical Education I 10 Units

Prerequisite: Satisfactory completion of the first (Fall) semester of the Diagnostic Medical Sonography Program and DMS 172 C with a minimum grade of “C”.

Term hours: 540 laboratory TBA. This course offers a minimum of 480 hours of clinical experience at an affiliated hospital/medical center. This course will provide basic instruction and scanning experiences in abdomen sonography. The student will be able to demonstrate the ability to perform sonographic examinations of the abdomen according to the protocols established by the program and clinical education center utilizing sonographic equipment. (CSU)

DMS 210 C Review Seminar 2 Units

Prerequisite: DMS 188 C and DMS 217 C with minimum grades of “C”.

Corequisite: DMS 227 C.

Term hours: 36 lecture. This course will prepare the student to enter the workforce by combining all skills acquired during didactic and clinical training. This course correlates and analyzes information pertaining to ultrasound case studies. The student will achieve an in depth comprehension and an increased level of understanding of clinical symptoms, sonographic patterns, alternative imaging procedures, and technical pitfalls associated with a diagnostic ultrasound exam. Review of abdomen, small parts, physics, obstetric and gynecology will be included to help prepare the student for the American Registry of Diagnostic Medical Sonography test. (CSU)

DMS 217 C Clinical Education II 7 Units

Prerequisite: Successful completion of the second semester (Spring) of the Diagnostic Medical Sonography Program and DMS 207 C with a minimum grade of “C”.

Corequisite: DMS 188 C.

Term hours: 396 laboratory TBA. This course requires a minimum of 384 hours of clinical experience at an affiliated hospital/medical center. This course will provide basic instruction and scanning experiences in breast, thyroid, scrotum, and doppler sonography. The student will be able to demonstrate the ability to perform sonographic examinations of small parts according to the protocols established by the program and clinical education center utilizing sonography equipment. (CSU)

DMS 227 C Clinical Training III 11 Units

Prerequisite: Successful completion of the Summer session of the Diagnostic Medical Sonography Program and DMS 217 C with a minimum grade of “C”.

Term hours: 612 laboratory. This course requires a minimum of 544 hours of clinical training at an affiliated hospital/medical center. This course will provide the basic instruction and scanning experiences in obstetrics and gynecology sonography. The student will be able to demonstrate the ability to perform sonographic examinations of the gravid and non-gravid pelvis according to the protocols established by the program and clinical education center utilizing sonography equipment with both transabdominal and endocavity transducers. (CSU)

**Drafting — See
Engineering Technology (ENGT)****Economics****Division of Social Sciences**

Division Dean — Lisa Gaetje, Interim

Faculty

Fola Odebunmi
Parwinder Sidhu

Counselors

Therese Mosqueda-Ponce
Daniel Pelletier

PROGRAM LEARNING OUTCOMES (PLOs)

The courses taught by this department contribute to the General Education and Basic Skills Program Learning Outcomes. Please refer to General Education and Basic Skills Program Learning Outcomes.

BUSINESS ECONOMICS**CERTIFICATE****Program Code: 1C17172**

Combining economics principles with business practices, this certificate program provides students with the necessary knowledge to make informed financial decisions. Students will gain an understanding of supply and demand and resource allocation issues, marketplace competitive factors, consumer purchasing patterns, and money-management and investment strategies.

To earn a certificate, students must complete the required courses as listed with a minimum grade of “C.” At least 50% of all course work must be completed at Cypress College.

Required courses are listed in suggested sequence:

| Course # | Title | Units |
|-----------------------------|---------------------------------------|-----------|
| ECON 105 C** | Principles of Economics — Micro or | 3 |
| ECON 105HC** | Honors Principles of Economics | (3) |
| MGT 161 C | Introduction to Business | 3 |
| ECON 130 C | Consumer Economics or | 3 |
| MKT 210 C | Consumer Behavior | (3) |
| MGT 101 C | Personal Finance or | 3 |
| MGT 102 C | Financial Literacy | (3) |
| Total Units Required | | 12 |

**A score of 3 or higher on the Advanced Placement (AP) Economics (micro) exam meets this requirement upon petition through Admissions and Records. See a counselor for more information.

ASSOCIATE IN ARTS IN ECONOMICS FOR TRANSFER DEGREE (AA-T) Program Code: 1A35301

This curriculum is designed to provide an opportunity for the economics major to achieve an Associate in Arts in Economics (AA-T in economics) which completes the first and second year requirements for transfer to a four-year public California institution. This degree is designed to provide students with a comprehensive introduction to the two major fields of economics in order to give them the background knowledge needed by undergraduate economics majors. The coursework emphasizes the practical applications of economics and knowledge in a diversity of careers and the utility of economics perspectives as a life-long learning tool for interpreting world economic events. Students successfully completing the AA-T in Economics will acquire a fundamental knowledge base of economics, learn basic knowledge and possess a basic understanding of areas that have an interdisciplinary association to Economics. This degree will provide students with an introduction to the field and its applied areas. While at least a baccalaureate degree is recommended preparation for those seeking professional careers, completion of this degree is excellent general preparation for careers in academic and applied economics, research institutes, financial institutions, education, international economic systems, corporations, government, journalism and technical writing, non-profit organizations, and many other careers. It gives students a solid basis for many career paths and can be enhanced with multidisciplinary study in related fields. This curriculum specifically prepares the prospective transfer student for upper division coursework in Economics or a similar major at a California State University (CSU) campus. At the baccalaureate level students can continue an education in various areas of Economics including Comparative Economic Systems, Environmental Economics, American Economic History, International Economics, Economic Geography, and many more. Graduate study is important in Economics. Those holding a Master's or Doctoral degree may find employment in college and university teaching and other educational institutions. Those without a graduate degree will find limited career opportunity in direct areas of Economics. Students should consult a counselor, the Transfer Center and the catalog of the transfer-college or university to plan a specific program of study to meet the college or university's requirements. Note: Courses that fulfill major requirements for an Associate Degree for Transfer at Cypress College might not be the same as those required for completing the major at all transfer institutions offering a Baccalaureate Degree. The Student Transfer Achievement Reform Act (Senate Bill 1440, now codified in California Education Code sections 66746–66749) guarantees admission to a California State University (CSU) campus for any community college student who completes an

“associate degree for transfer”, a newly established variation of the associate degrees traditionally offered at a California community college. Students completing the AA-T are guaranteed admission to the CSU system, but not to a particular campus or major. Students transferring to a CSU campus that does accept the AA-T will be required to complete no more than 60 units after transfer to earn a bachelor's degree (unless the major is designated “high-unit” major). This degree may not be the best option for students intending to transfer to a particular CSU campus or to a university or college that is not part of the CSU system. To earn an AA-T in Economics students must complete: 1) a minimum of 20–22 semester or 30–33 quarter units in the Economics major with a minimum grade of “C”; (2) California State University General Education Breadth requirements (CSU GE Breadth) or the Intersegmental General Education Transfer Curriculum (CSU IGETC); (3) completion of 60 semester units of CSU transferable coursework; and (4) have an overall GPA of 2.0.

| Required Core Courses (14 units): | | Units |
|---|--|--------------|
| ECON 100 C | Principles of Economics-Macro or | 3 |
| ECON 100HC | Honors Principles of Economics | (3) |
| ECON 105 C | Principles of Economics-Micro or | 3 |
| ECON 105HC | Honors Principles of Economics | (3) |
| MATH 120 C | Introduction to Probability and Statistics | 4 |
| MATH 130 C | Survey of Calculus or | 4 |
| MATH 150AC | Calculus I | (4) |
| List A: Select One Course (3–4 units) | | Units |
| MATH 115 C | Finite Mathematics | 4 |
| MATH 150BC | Calculus II | 4 |
| ACCT 101 C | Financial Accounting | 4 |
| CIS 111 C | Computer Information Systems | 3 |
| MGT 211 C | Writing for Business | 3 |
| List B: Select One Course (3–4 units) or any course not used in List A | | Units |
| ACCT 102 C | Managerial Accounting | 4 |
| ECON 110 C | Survey of Economics | 3 |
| ECON 120 C | International Economics | 3 |
| ECON 130 C | Consumer Economics | 3 |
| MATH 250AC | Multivariable Calculus | 4 |
| Total Units | | 20–22 |

ECONOMICS TRANSFER PROGRAM

Students should consult a counselor or www.assist.org for lower division major requirements for most California public universities. (See the Standard Definitions section of the catalog for a description of ASSIST.) Students transferring to an independent college/university should consult the catalog of the individual school and a counselor for lower division major requirements.

Economics (ECON)

ECON 100 C Principles of Economics-Macro **3 Units**

Prerequisite: MATH 040 C or MATH 041 C with a minimum grade of “C”.

Term hours: 54 lecture. The course concentrates on macroeconomics analysis. Topics emphasized are aggregate supply/demand concepts, economic aggregates and the overall functioning of the American economy, with special emphasis on the role of the government. The course includes national income accounting, employment theory, business cycles, fiscal and monetary policy and economic growth. Duplicate credit not granted for ECON 100HC. (UC Credit Limitation/CSU, AA GE, CSU GE, IGETC, C-ID: ECON 202)

ECON 100HC Honors Principles of Economics 3 Units*Prerequisite: MATH 040 C or MATH 041 C with minimum grades of "C".*

Term hours: 54 lecture. This course is an enhanced study of macroeconomics, focusing on the structure and operation of the American economy. Special topics include simulated practice of fiscal and monetary policy, and web-site updates of statistical economics. Duplicate credit not granted for ECON 100 C. (UC Credit Limitation/CSU, AA GE, CSU GE, IGETC, C-ID: ECON 202)

ECON 105 C Principles of Economics-Micro 3 Units*Prerequisite: MATH 040 C or MATH 041 C with a minimum grade of "C".*

Term hours: 54 lecture. This course concentrates on microeconomic analysis. Topics emphasized are basic structure of the United States economic system, and interrelationships within this structure. The course includes a study of supply and demand, price determination, the market models, resource pricing and allocation, comparative economic systems, and foreign trade/exchange analysis. Duplicate credit not granted for ECON 105HC. (UC Credit Limitation/CSU, AA GE, CSU GE, IGETC, C-ID: ECON 201)

ECON 105HC Honors Principles of Economics 3 Units*Prerequisite: MATH 040 C or MATH 041 C with minimum grades of "C".*

Term hours: 54 lecture. This course is an enhanced study of microeconomics analysis with special attention given to web-based interactive material on topics such as: price determination; the market models; comparative economic analysis; and international trade and finance. Duplicate credit not granted for ECON 105 C. (UC Credit Limitation/CSU, AA GE, CSU GE, IGETC, C-ID: ECON 201)

ECON 110 C Survey of Economics 3 Units

Term hours: 54 lecture. This course is a survey of the American Economic System using basic economic concepts to explain a wide variety of economic applications. It includes production and cost, competition and market structure, market failure and externalities, and the labor market as the microeconomic topics. As macroeconomic topics, it includes national income, unemployment and inflation. It also discusses the economic growth and economic fluctuations issues, monetary and fiscal policy, and international trade and finance. Economics 110 C does not meet the course requirement for majors in economics and business administration. No UC credit if taken after ECON 100 C/100HC or ECON 105 C/105HC. (UC Credit Limitation/CSU, AA GE, CSU GE, IGETC)

ECON 120 C International Economics 3 Units*Prerequisite: ECON 100 C with a minimum grade of "C".*

Term hours: 54 lecture. Institutions in the global economy, International trade and labor and environmental standards, Trade and balance of payments, Exchange rate and exchange rate systems, International financial crisis, Economic integration in North America, The European Union, Trade and policy reforms in Latin America, Export-Oriented growth in East Asia. (UC/CSU, AA GE, CSU GE)

ECON 130 C Consumer Economics 3 Units

Term hours: 54 lecture. This course explains why and how students as consumers can help shape the market place. It includes personal finance topics such as credit, saving, investment, taxes, consumer responsibilities, influence of advertising, issues on health and wellness, issues of identity theft and fraud. Consumer issues, ethics and globalization will also be emphasized. Economics 130 C does not meet the course requirement for majors in economics and business administration. (CSU)

ECON 260 C Economic Geography 3 Units

Same as GEOG 260 C

Term hours: 54 lecture. Investigation and interpretation of the world's economic organization, its natural resources, raw material, crop and crop production, manufacturing and service industries, new trends in producing, and the changing centers of production and consumption are covered in this course. Duplicate credit not granted for GEOG 260 C. (UC/CSU, CSU GE, IGETC)

ECON 298 C Economics Seminar .5 to 12 Units*Prerequisite: May be required.**Corequisite: May be required.**Advisory: May be required.*

Term hours: 0-216 lecture and/or 0-432 laboratory depending on units attempted. This is a lecture/discussion type course developed on a particular limited problem or topic of interest to students. It is designed for able students who wish to increase their knowledge of a particular topic concerning which no other regular class is offered. A paper or group activity may be requested. Credit may range from 1/2 unit to 12 units. Consult class schedule for the offerings in a particular semester. May be taken for credit 1-4 times. Pass/No Pass or Pass/No Pass/Letter Grade Option or Standard Letter Grade. Fees may be required-Payable at Registration. (UC Credit Limitation/CSU)

ECON 299 C Economics Independent Study 1 Unit*Prerequisite: Approved Independent Study Learning Contract.*

Term hours: Varying hours of scheduled conferences per week according to instructor. Independent study is for able students who wish to extend their knowledge of a particular area through individual research and study. It is thought that topics might develop out of a curiosity stimulated in a regular class. The student would then contact the supervising instructor to develop a contract for his/her particular interest so that they could learn more regarding their special topic. May be taken for credit 3 times. (UC Credit Limitation/CSU)

Education

Division of Social Sciences

Division Dean — Lisa Gaetje, Interim*Counselors*

Therese Mosqueda-Ponce

Daniel Pelletier

ASSOCIATE IN ARTS IN ELEMENTARY TEACHER EDUCATION FOR TRANSFER DEGREE (AA-T) **Program Code: 1A32138**

This curriculum is designed to provide an opportunity for the Elementary Teacher Education major to achieve an Associate in Arts in Elementary Teacher Education for Transfer (AA-T in Elementary Teacher Education) which completes the first and second year requirements for transfer to a four-year public California institution. While at least a baccalaureate degree is recommended preparation for those considering professional careers, completion of this curriculum will demonstrate commitment to the field and provide comprehensive preparation for further academic study through upper-division course work. This curriculum specifically prepares the prospective transfer student for upper division course work in Elementary Teacher Education or a similar major at a California State University (CSU) campus. Students should consult a counselor,

the Transfer Center and the catalog of the transfer college or university to plan a specific program of study to meet the college or university's requirements.

Note: Courses that fulfill major requirements for an Associate Degree for Transfer at Cypress College might not be the same as those required for completing the major at all transfer institutions offering a Baccalaureate Degree. The Student Transfer Achievement Reform Act (Senate Bill 1440, now codified in California Education Code sections 66746–66749) guarantees admission to a California State University (CSU) campus for any community college student who completes an “associate degree for transfer,” a newly established variation of the associate degrees traditionally offered at a California community college. The AA-T is intended for students who plan to complete a bachelor's degree in a similar major at a CSU campus. Students completing these degrees (AA-T) are guaranteed admission to the CSU system, but not to a particular campus or major. Students transferring to a CSU campus that does accept the AA-T will be required to complete no more than 60 units after transfer to earn a bachelor's degree (unless the major is designated “high-unit” major). This degree may not be the best option for students intending to transfer to a particular CSU campus or to a university or college that is not part of the CSU system. Students should consult with a counselor when planning to complete the degree for more information on university admission and transfer requirements. Students with a degree in Elementary Teacher Education may pursue a career as a teacher in elementary education.

To earn an AA-T in Elementary Teacher Education students must complete the following requirements: (1) a minimum of 51–52 semester units or 76.5–78 quarter units in the Elementary Teacher Education major with a minimum grade of “C”; (2) California State University General Education Breadth requirements (CSU GE Breadth) or the Intersegmental General Education Transfer Curriculum (CSU IGETC); (3) completion of 60 semester or 90 quarter units of CSU transferable course work; and (4) have an overall GPA of 2.0.

| Required Core Courses (45 Units) | Units | |
|----------------------------------|-----------------------------------|-----|
| EDU 200 C | Elementary School Teaching | 3 |
| GEOL 105 C | Earth Science for Teachers | 4 |
| COMM 100 C | Human Communication | 3 |
| | or | |
| COMM 100HC | Honors Human Communication | (3) |
| ENGL 100 C | College Writing | 4 |
| | or | |
| ENGL 100HC | Honors College Writing | (4) |
| CHEM 104 C | Physical Science for Teachers | 4 |
| | or | |
| PHSC 104 C | Physical Science for Teachers | (4) |
| BIOL 101 C | General Biology | 5 |
| | or | |
| BIOL 101HC | Honors General Biology | (5) |
| MATH 110 C | Math for Prospective Teachers | 4 |
| HIST 112 C | World Civilizations I | 3 |
| | or | |
| HIST 112HC | Honors World Civilizations I | (3) |
| ENGL 102 C | Introduction to Literature | 3 |
| | or | |
| ENGL 102HC | Honors Introduction to Literature | (3) |
| GEOG 100 C | World Geography | 3 |
| | or | |
| GEOG 100HC | Honors World Geography | (3) |
| POSC 100 C | United States Government | 3 |
| | or | |
| POSC 100HC | Honors United States Government | (3) |

| | | |
|------------|---------------------------------------|-----|
| HIST 170 C | History of the United States I | 3 |
| | or | |
| HIST 170HC | Honors History of the United States I | (3) |
| PSY 145 C | Child Psychology | 3 |

| List A (Select One) Meets A3 CSU GE | Units | |
|-------------------------------------|---|-----|
| ENGL 103 C | Critical Reasoning and Writing | 4 |
| | or | |
| ENGL 103HC | Honors Critical Reasoning and Writing | (4) |
| ENGL 104 C | Critical Analysis and Literature | 4 |
| | or | |
| ENGL 104HC | Honors Critical Analysis and Literature | (4) |
| ENGL 106 C | Critical Reading, Writing and Thinking | 3 |
| PHIL 172 C | Critical Thinking and Writing | 3 |

| List B (Select One or Any Course Not Taken in List A) | Units | |
|---|-----------------------------|---|
| ART 110 C | Introduction to Art | 3 |
| MUS 116 C | Music Appreciation | 3 |
| THEA 100 C | Introduction to the Theater | 3 |

Please see the Elementary Education Counselors for specific electives.

Total Units Required **51–52**

Education (EDU)

EDU 200 C Elementary School Teaching 3 Units

Advisory: Completion of COUN 110 C or at least one year as a paraprofessional in a public school setting.

Term hours: 45 lecture and 45 laboratory TBA. This course provides an overview of the teaching profession for students who are considering a career in elementary school teaching. The course will address the philosophies of education, the history of education in America, the sociology of education, contemporary issues in education, and the role of education in American society. In addition, students will gain experience through 45 hours of required fieldwork in K-6 elementary classrooms. (CSU, C-ID: EDUC 200)

EDU 225 C Secondary School Teaching 3 Units

Advisory: COUN 110 C.

Term hours: 45 lecture and 45 laboratory TBA. History, philosophy, and sociology of secondary education. Introduction to the California Teaching Performance Expectations and Assessment; needs of special populations, English learners, and struggling readers; content standards; and major curriculum reform documents. In addition, students will gain experience through 45 hours of required fieldwork in secondary classrooms. Students will divide the 45 hours as follows: 30 hours at one site and 15 hours in various other sites/activities for diversity. (CSU)

Electronics — See Engineering Technology (ENGT)

Energy Sustainable Technology

Division of Career Technical Education

Division Dean — Kathleen Reiland, Interim

Faculty

Doug Sallade

Counselor

Jane Jepson

GEOHERMAL ENERGY CERTIFICATE

Program Code: 1C33923

The Geothermal Energy Certificate provides students with a career path for attaining the communication skills, practical knowledge, and technical training necessary for pursuing a career in geothermal technologies certification. Students completing this certificate will develop an advanced understanding of the technologies involved in the geothermal energy industry. To earn this certificate, complete the required courses as listed with a minimum grade of “C”. At least 50% of all major course work must be completed at Cypress College.

| Required courses are listed in suggested sequence: | | Units |
|---|--|--------------|
| EST 100 C | Renewable and Sustainable Energy | 3 |
| EST 110 C | Tools and Safety | 2 |
| EST 120 C | Digital Controls and Inverters | 2 |
| AC/R 105 C | Electricity for Air Conditioning and Refrigeration I | 3 |
| AC/R 100 C | Principles of Thermodynamics and Heat Transfer | 3 |
| EST 150 C | Advanced Geo-thermal Concepts | 3 |
| Total Units Required | | 16 |

ASSOCIATE IN SCIENCE DEGREE ENERGY AND SUSTAINABLE TECHNOLOGIES

Program Code: 1S35037

The following program is designed to prepare students for employment in the emerging industry of sustainable energy technologies. Training is given in both theory and practical skills. Directed practical work is given in all areas of energy technology maintenance and repair under simulated on-the-job conditions. The sequence in which courses are taken may be modified to meet individual needs.

To earn an Associate Degree students must complete: (1) all major course requirements with a minimum grade of “C”; (2) 25 units of General Education Graduation Requirements; (3) any elective courses to complete a minimum of 60 units; and, (4) have a minimum GPA of 2.0. At least 50% of all major course work must be completed at Cypress College. Courses that fulfill major requirements for an Associate Degree at Cypress College might not be the same as those required for completing the major at a transfer institution offering a Baccalaureate Degree. For information on specific university requirements, please consult with your counselor, or visit the Transfer Center.

| Required courses are listed in suggested sequence: | | Units |
|---|--|--------------|
| EST 100 C | Renewable and Sustainable Energy | 3 |
| EST 110 C | Tools and Safety | 2 |
| EST 120 C | Digital Controls and Inverters | 2 |
| AC/R 100 C | Principles of Thermodynamics and Heat Transfer | 3 |
| AC/R 105 C | Electricity for Air Conditioning and Refrigeration I | 3 |
| EST 130 C | Solar Photovoltaics-install | 3 |
| EST 135 C | Solar Concentrators-Hot Water | 3 |
| EST 140 C | Wind Turbine Drive Trains | 3 |
| EST 145 C | Wind Turbine Power Generation | 3 |
| EST 150 C | Advanced Geo-thermal Concepts | 3 |
| MATH 100 C | Liberal Arts Mathematics | 3 |
| PHYS 130 C | Elementary Physics | 4 |
| Total Units Required | | 35 |

SOLAR ENERGY CERTIFICATE

Program Code: 1C33913

The Solar Energy Certificate provides students with a career path for attaining the communication skills, practical knowledge, and technical training necessary for pursuing a career in solar technologies certification. Students completing this certificate will develop an advanced understanding of the technologies involved in the solar energy industry. To earn this certificate, complete the required courses as listed with a minimum grade of “C”. At least 50% of all major course work must be completed at Cypress College.

| Required courses are listed in suggested sequence: | | Units |
|---|--|--------------|
| EST 100 C | Renewable and Sustainable Energy | 3 |
| EST 110 C | Tools and Safety | 2 |
| EST 120 C | Digital Controls and Inverters | 2 |
| EST 130 C | Solar Photovoltaics-install | 3 |
| EST 135 C | Solar Concentrators-Hot Water | 3 |
| AC/R 105 C | Electricity for Air Conditioning and Refrigeration I | 3 |
| Total Units Required | | 16 |

SUSTAINABLE ENERGY CERTIFICATE

Program Code: 1C35041

The Sustainable Energy Certificate provides students with a career path for attaining the communication skills, practical knowledge, and technical training necessary for pursuing a career in sustainable technologies certification. Students completing this certificate will develop an advanced understanding of the technologies involved in the sustainable energy industry.

To earn this certificate, complete the required courses as listed with a minimum grade of “C”. At least 50% of all major course work must be completed at Cypress College.

| Required courses are listed in suggested sequence: | | Units |
|--|--|-----------|
| EST 100 C | Renewable and Sustainable Energy | 3 |
| EST 110 C | Tools and Safety | 2 |
| EST 120 C | Digital Controls and Inverters | 2 |
| AC/R 105 C | Electricity for Air Conditioning and Refrigeration I | 3 |
| EST 130 C | Solar Photovoltaics-install or | 3 |
| EST 135 C | Solar Concentrators-Hot Water | (3) |
| EST 140 C | Wind Turbine Drive Trains or | 3 |
| EST 145 C | Wind Turbine Power Generation | (3) |
| EST 150 C | Advanced Geo-thermal Concepts | 3 |
| AC/R 100 C | Principles of Thermodynamics and Heat Transfer | 3 |
| Total Units Required | | 22 |

WIND ENERGY CERTIFICATE

Program Code: 1C33719

The Wind Energy Certificate provides students with a career path for attaining the communication skills, practical knowledge, and technical training necessary for pursuing a career in wind energy technologies certification. Students completing this certificate will develop an advanced understanding of the technologies involved in the wind energy industry. To earn this certificate, complete the required courses as listed with a minimum grade of "C". At least 50% of all major course work must be completed at Cypress College.

| Required courses are listed in suggested sequence: | | Units |
|--|--|-----------|
| EST 100 C | Renewable and Sustainable Energy | 3 |
| EST 110 C | Tools and Safety | 2 |
| EST 120 C | Digital Controls and Inverters | 2 |
| AC/R 105 C | Electricity for Air Conditioning and Refrigeration I | 3 |
| EST 140 C | Wind Turbine Drive Trains | 3 |
| EST 145 C | Wind Turbine Power Generation | 3 |
| Total Units | | 16 |

Energy Sustainable Technology (EST)

EST 100 C Renewable and Sustainable Energy 3 Units

Term hours: 27 lecture and 81 laboratory. This course investigates the potential of renewable energy technologies to help solve environmental and economic problems within society. Areas of investigation include solar energy, wind power, hydropower, geothermal, fuel cells, biomass, ocean wave power, and alternative transportation options. Also addressed are conventional energy sources including oil, coal, natural gas, and nuclear energy. Consideration will be given to related issues such as costs, externalities, system efficiencies, emissions and other environmental impacts, financing incentives, and the regulatory and market forces impacting the alternative energy industry. Students will learn how to assess the viability of incorporating renewable technology, such as solar or wind power, for residential and commercial applications. (UC/CSU)

EST 110 C Tools and Safety 2 Units

Term hours: 27 lecture and 27 laboratory. This course covers the concepts and practices of a safe working environment in the renewable energy field. Topics that are covered include PPE, rigging, body harness, ladder safety, sound/hearing safety, etc. (CSU)

EST 120 C Digital Controls and Inverters 2 Units

Term hours: 27 lecture and 27 laboratory. The course covers basic concepts of electronic controls, fiber optics, soldering techniques, PLC controls, substations, generators and transformers as they apply to Energy Sustainability Technology. (CSU)

EST 130 C Solar Photovoltaics-install 3 Units

Prerequisite: AC/R 105 C, EST 100 C, EST 110 C and EST 120 C.

Term hours: 27 lecture and 81 laboratory. This course will explore the use of sunlight to produce electricity. Practical & economical design of photovoltaic power systems, site analysis, system sizing, equip. specs & component selection, code requirements, economics of PV systems, and energy efficiency and conservation impacts on system design will be covered. (CSU)

EST 135 C Solar Concentrators-Hot Water 3 Units

Prerequisite: EST 100 C, EST 110 C, EST 120 C and AC/R 105 C all with minimum grades of "C".

Term hours: 27 lecture and 81 laboratory. In this course, students will learn theory, setting, design, procurement & techniques required to install & maintain a solar hot water system. Examine passive/active, unglazed/ glazed, evacuated tube, and concentrated solar technologies, optimal designs, alternative space heating, building codes, utility conservation programs, and site & federal incentives. (CSU)

EST 140 C Wind Turbine Drive Trains 3 Units

Prerequisite: EST 100 C, EST 110 C, EST 120 C and AC/R 105 C with minimum grades of "C".

Term hours: 27 lecture and 81 laboratory. This course covers basic wind turbine drive train assembly, maintenance, fasteners, torquing procedures, repair, and control systems. (CSU)

EST 145 C Wind Turbine Power Generation 3 Units

Prerequisite: EST 100 C, EST 110 C, EST 120 C and AC/R 105 C with minimum grades of "C".

Term hours: 27 lecture and 81 laboratory. This course covers advanced wind turbine power generation, power generation assembly, maintenance, repair, electrical transmission, substations, and transformers. (CSU)

EST 150 C Advanced Geo-thermal Concepts 3 Units

Prerequisite: AC/R 105 C, EST 100 C, EST 110 C, and EST 120 C all with minimum grades of "C".

Term hours: 27 lecture and 81 laboratory. This course is designed to instruct the student in the application of advanced Geo-thermal technologies. Included will be heat pump technology, and ground-source heat exchangers. Students will apply the theories and skills taught in the classroom on laboratory mock-ups simulating industry standards. (CSU)

Engineering

Division of Science/Engineering/Mathematics

Division Dean — Richard Fee

Faculty

Massoud Saleh

Counselor

Deidre Porter

ASSOCIATE IN SCIENCE DEGREE

PRE-ENGINEERING Program Code: 1S03770

This Pre-Engineering program is designed to prepare students for junior standing at most CSU and UC institutions. To earn an Associate Degree students must complete: (1) all major course requirements with a minimum grade of “C”; (2) 25 units of General Education Graduation Requirements; (3) the cultural diversity and reading requirements; (4) any elective courses to complete a minimum of 60 units; and, (5) have a minimum GPA of 2.0. At least 50% of all major course work must be completed at Cypress College.

Courses that fulfill major requirements for an Associate Degree at Cypress College might not be the same as those required for completing the major at a transfer institution offering a Baccalaureate Degree. For information on specific university requirements, please consult with your counselor, or visit the Transfer Center.

Required courses are listed in suggested sequence:

| Course # | Title | Units |
|-----------------------------|---------------------------------------|-----------|
| *MATH 150AC | Calculus I | 4 |
| **MATH 150BC | Calculus II | 4 |
| MATH 250AC | Multivariable Calculus | 4 |
| MATH 250BC | Linear Algebra/Differential Equations | 5 |
| PHYS 221 C | General Physics I | 4 |
| PHYS 222 C | General Physics II | 4 |
| PHYS 223 C | General Physics III | 4 |
| CHEM 111AC | General Chemistry I | 5 |
| CHEM 112 C | Chemistry for Engineers | 3 |
| ENGR 102 C | Engineering Graphics | 3 |
| ENGR 110 C | Introduction to Engineering | 3 |
| ENGR 201 C | Statics | 3 |
| ENGR 210 C | Electric Circuits | 5 |
| Total Units Required | | 51 |

*A score of 3 or higher on the Advanced Placement (AP) Math (Calculus AB) exam meets this requirement upon petition through Admissions and Records. See a counselor for more information.

**A score of 3 or higher on the Advanced Placement (AP) Math (Calculus BC) exam meets this requirement upon petition through Admissions and Records. See a counselor for more information.

ENGINEERING TRANSFER PROGRAM

Students should consult a counselor or www.assist.org for lower division major requirements for most California public universities. (See the Standard Definitions section of the catalog for a description of ASSIST.) Students transferring to an independent college/university should consult the catalog of the individual school and a counselor for lower division major requirements.

Engineering (ENGR)

ENGR 102 C Engineering Graphics 3 Units

Term hours: 36 lecture and 72 laboratory. This is an introductory course which utilizes drafting and the CAD system for engineering applications. The course incorporates elementary principles associated with the board drawing and the various menu and command structures in computer-assisted drafting (CAD) in order to develop solutions to 2D and 3D design problems. Topics included are drawing of points, lines, planes, plane intersections, orthographic projection, dimensioning, line types, tolerances, file management, and layering. (UC/CSU)

ENGR 110 C Introduction to Engineering 3 Units

Same as ENGT 110 C

Prerequisite: MATH 040 C or MATH 041 C with minimum grades of “C”.

Term hours: 54 lecture. This course is an introduction to engineering as a profession and its associated career responsibilities and opportunities. It also presents an overview of each engineering discipline; illustrates opportunities and challenges in the engineering profession and provides tools for becoming a successful student. Students learn about current trends and issues in engineering career and academic options. Representatives from industry and academic institutions present overviews of the engineering field and describe potential job opportunities. Field trips to various companies and engineering facilities provide an insight into different aspects of engineering. This course includes the application of engineering and scientific problem solving methods to introductory mechanics and electricity. It also meets requirements for credit in Engineering. Pass/No Pass/Letter Grade Option. (UC/CSU)

ENGR 201 C Statics 3 Units

Prerequisite: ENGR 110 C, PHYS 201 C or PHYS 221 C, MATH 142 C or MATH 150AC.

Term hours: 54 lecture. This course includes the study of force systems, equilibrium conditions, and analytical vector mechanics as applied to practical engineering problems. It includes force and moment equilibrium analysis of solid bodies, beams, machine members, and structures in two and three dimensions. It also incorporates topics such as elementary bending moment, shear analysis of simple beams, and distributed beam loading, centroids, friction forces, fluid forces on submerged surfaces, virtual work, and moment of inertia. (UC/CSU)

ENGR 205 C Advanced Engineering Autocad 3 Units

Prerequisite: ENGR 102 C with a minimum grade of “C”.

Term hours: 36 lecture and 72 laboratory. This is an advanced course in Computer Aided Design CAD (AutoCAD 2013) systems that emphasize the use of surfaces, surfaces of revolution, solids (primitives) and extrusions techniques to create 3D working drawings. Students will learn to convert 3D drawings by layout methods to 2D drawings that emphasize baseline dimensioning with tolerances, notes, weights and bill of materials. They will also learn to write unique graphical programs by using LISP. (CSU)

ENGR 210 C Electric Circuits 5 Units

Prerequisite: PHYS 222 C, MATH 250AC, and ENGR 110 C with minimum grades of “C”.

Term hours: 72 lecture and 54 laboratory. The course consists of an introduction to analysis of circuits under steady state and transient conditions. Analysis techniques include nodal analysis, loop analysis, superposition method, Thevenin’s Theorem, Norton’s Theorem and source transformation. RLC circuits are analyzed under DC, AC—steady state and transient conditions using multiple methods including bode diagrams, Fourier and Laplace transforms. (UC/CSU)

Flow Chart for Physics/Engineering Courses

Courses

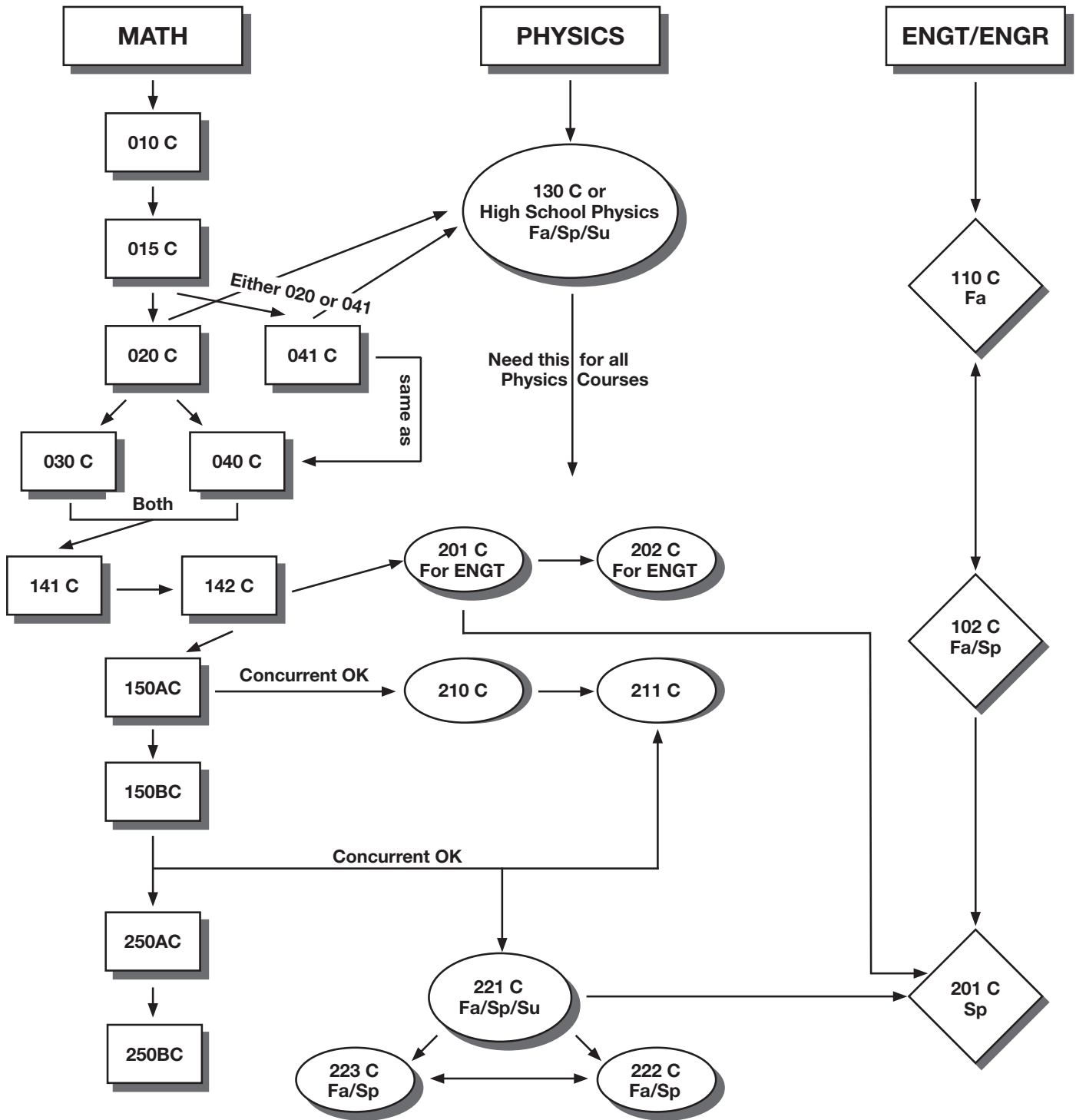

Fa = Fall Sp = Spring Su = Summer

Contact: Dr. Brinda Subramaniam: bsubramaniam@CypressCollege.edu or (714) 484-7000 x48645
 or Massoud Saleh: msaleh@CypressCollege.edu

ENGR 299 C Independent Study .5 to 2 Units*Prerequisite: Approved Independent Study Contract.*

Term hours: 0-36 lecture and/or 0-108 laboratory depending on units attempted. Students who wish to increase their knowledge of engineering design and testing process through individual study, research or internships may enroll in this class. Permission of the instructor is required along with a contract outlining a student's independent work and the supervision of the instructor. Pass/No Pass/Letter Grade Option. (UC/CSU Credit Limitation)

Engineering Technology

Division of Science/Engineering/Mathematics

Division Dean — Richard Fee*Faculty*

Brinda Subramaniam

Counselor

Deidre Porter

ENGINEERING TECHNOLOGY TRANSFER PROGRAM

Students should consult a counselor or www.assist.org for lower division major requirements for most California public universities. (See the Standard Definitions section of the catalog for a description of ASSIST.) Students transferring to an independent college/university should consult the catalog of the individual school and a counselor for lower division major requirements.

Other specializations include: Construction, Manufacturing, and Quality Assurance.

Engineering Technology (ENGT)

ENGT 110 C Introduction to Engineering 3 Units

Same as ENGR 110 C

Prerequisite: MATH 040 C and MATH 041 C with minimum grades of "C".

Term hours: 54 lecture. This course is an introduction to engineering as a profession and its associated career responsibilities and opportunities. It also presents an overview of each engineering discipline; illustrates opportunities and challenges in the engineering profession and provides tools for becoming a successful student. Students learn about current trends and issues in engineering career and academic options. Representatives from industry and academic institutions present overviews of the engineering field and describe potential job opportunities. Field trips to various companies and engineering facilities provide an insight into different aspects of engineering. This course includes the application of engineering and scientific problem solving methods to introductory mechanics and electricity. It also meets requirements for credit in Engineering. Pass/No Pass/Letter Grade Option. Duplicate credit not granted for ENGR 110 C. (UC/CSU)

English

Division of Language Arts

Division Dean — Eldon Young*Faculty*

Linda Borla
Cherie Dickey
Christie Diep
Mary Forman
Cathy Franklin
Janet Fujimoto
Ruth Ann Gutierrez
Sarah Jones
Barbara Kashi
Lawrence Keel
Susan Klein
Annette Letcher
Barbara Marshall
Kathleen McAlister
Joseph Melodia
Melanie Nabahani
Kendyl Palmer
John Payne
Stuart Rosenberg
Kathryn Sonne
Ambika Talwar
Keith Vescial
Randa Wahbe

Counselors

Therese Mosqueda-Ponce
Daniel Pelletier

PROGRAM LEARNING OUTCOMES (PLOs)

The courses taught by this department contribute to the General Education and Basic Skills Program Learning Outcomes. Please refer to General Education and Basic Skills Program Learning Outcomes.

ENGLISH TRANSFER PROGRAM

Students should consult a counselor or www.assist.org for lower division major requirements for most California public universities. (See the Standard Definitions section of the catalog for a description of ASSIST.) Students transferring to an independent college/university should consult the catalog of the individual school and a counselor for lower division major requirements.

Flow Chart for Pre-English 100 C Courses

Students are advised to take English classes according to scores on the following test:

COLLEGE TEST FOR ENGLISH PLACEMENT (CTEP)

The CTEP is designed to measure the English skills of native speakers of English. It is required for proper placement in English courses. Exemptions are: completion of an AA degree or higher, enrollment in one class that has no prerequisite; transcripts/grade reports showing completion of college English with a grade of "C" or better. The CTEP may not be used for placement in ESL courses.

Students with appropriate scores on the CTEP will be advised to take ENGL 100 C (College Writing). Students needing additional fundamental work will be advised to take either ENGL 057 C (Reading and Writing I), ENGL 058 C (Reading and Writing II), or ENGL 060 C (Preparation for College Writing). Students enrolled in pre-English 100 C classes must earn at least a "C" grade in ENGL 060 C or a grade of "C" in ESL 186 C to be eligible for enrollment in ENGL 100 C. All students are encouraged to complete their English coursework as early as possible in their educational programs.

Students enrolled in core classes will be required to write an essay on the first day of instruction to verify skill level and assessment placement score.

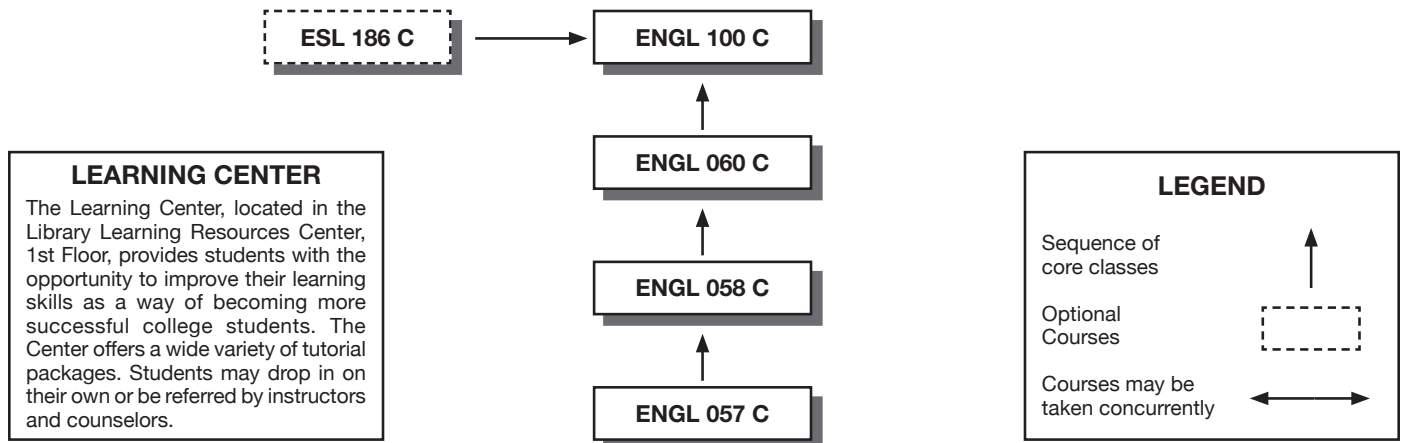

ASSOCIATE IN ARTS IN ENGLISH FOR TRANSFER DEGREE (AA-T) Program Code: 1A32000

This curriculum is designed to provide an opportunity for the English major to achieve an Associate in Arts Degree in English for Transfer (AA-T in English) which completes the first and second year requirements for transfer to a four-year public California institution. While at least a baccalaureate degree is recommended preparation for those considering professional careers, completion of this curriculum will demonstrate commitment to the field and provide comprehensive preparation for further academic study through upper-division course work. This degree is designed to prepare students to read and write critically about literature and to understand key historical and generic influences in the production and reception of literature and other cultural texts. This curriculum specifically prepares the prospective transfer student for upper division course work in English or a similar major at a California State University (CSU) campus. Students should consult a counselor, the Transfer Center, and the catalog of the transfer college or university to plan a specific program of study to meet the college or university's requirements.

Note: Courses that fulfill major requirements for an Associate Degree for Transfer at Cypress College might not be the same as those required for completing the major at all transfer institutions offering a Baccalaureate Degree. The Student Transfer Achievement Reform Act (Senate Bill 1440, now codified in California Education Code sections 66746–66749) guarantees admission to a California State University (CSU) campus for any community college student who completes

an "associate degree for transfer," a newly established variation of the associate degrees traditionally offered at a California community college. The AA-T is intended for students who plan to complete a bachelor's degree in a similar major at a CSU campus. Students completing these degrees (AA-T) are guaranteed admission to the CSU system, but not to a particular campus or major. Students transferring to a CSU campus that does accept the AA-T will be required to complete no more than 60 units after transfer to earn a bachelor's degree (unless the major is designated "high-unit" major). This degree may not be the best option for students intending to transfer to a particular CSU campus or to a university or college that is not part of the CSU system. Students should consult with a counselor when planning to complete the degree for more information on university admission and transfer requirements. The completion of this curriculum will demonstrate commitment to the English field and provide comprehensive preparation for upper-division work.

To earn an AA-T in English students must complete the following requirements: (1) a minimum of 19–21 semester units or 28.5–31.5 quarter units in the English major with a minimum grade of "C"; (2) California State University General Education Breadth requirements (CSU GE Breadth) or the Intersegmental General Education Transfer Curriculum (CSU IGETC); (3) completion of 60 semester or 90 quarter units of CSU transferable course work; and (4) have an overall GPA of 2.0.

Required Core: 1 or 2 courses depending on option selected (4–7 units).

Option 1: Choose 2 courses (7 units)

| | | |
|------------|--|-----|
| ENGL 102 C | Introduction to Literature or | 3 |
| ENGL 102HC | Honors Introduction to Literature and | (3) |
| ENGL 103 C | Critical Reasoning and Writing | 4 |

Option 2: Choose 1 course (4 units)

| | | |
|------------|---|-----|
| ENGL 104 C | Critical Analysis and Literature or | 4 |
| ENGL 104HC | Honors Critical Analysis and Literature | (4) |

Choose 2 courses (6 units).

List A:

| | | |
|------------|--------------------------------|---|
| ENGL 211 C | English Literature to 1760 | 3 |
| ENGL 212 C | English Literature Since 1760 | 3 |
| ENGL 221 C | American Literature to 1865 | 3 |
| ENGL 222 C | American Literature Since 1865 | 3 |

Select courses based on option chosen in Required Core:

If Option 1 selected for core, choose one course (3 units) from those not taken in List A or one course from List B below.

If Option 2 selected for core, choose two courses (6 units) from those not taken in List A, from List B below, or a combination from A and B.

| | | |
|------------|--------------------------------|-----|
| ENGL 105 C | Creative Writing | 3 |
| ENGL 208 C | Asian American Literature | (3) |
| ENGL 247 C | Multicultural Literature | (3) |
| ENGL 255 C | African-American Literature I | (3) |
| ENGL 256 C | African-American Literature II | (3) |

List C: Choose one course from the following, or any course not taken from List A or List B (3–5 units)

| | | |
|------------|----------------------------------|---|
| CHIN 101 C | Elementary Chinese — Mandarin I | 5 |
| CHIN 102 C | Elementary Chinese — Mandarin II | 5 |
| ENGL 110 C | Humanities: Ancient and Medieval | 3 |
| ENGL 111 C | Humanities: Renaissance–Present | 3 |
| ENGL 125 C | The Film | 3 |
| ENGL 125HC | Honors Film | 3 |
| ENGL 126 C | Screenwriting | 3 |
| ENGL 234 C | Shakespeare | 3 |
| ENGL 234HC | Honors Shakespeare | 3 |
| ENGL 239 C | Survey — Children’s Literature | 3 |
| FREN 101 C | Elementary French I | 5 |
| FREN 102 C | Elementary French II | 5 |
| FREN 203 C | Intermediate French III | 4 |
| FREN 204 C | Intermediate French IV | 4 |
| JAPN 101 C | Elementary Japanese I | 5 |
| JAPN 102 C | Elementary Japanese II | 5 |
| JAPN 203 C | Intermediate Japanese III | 4 |
| JAPN 204 C | Intermediate Japanese IV | 4 |
| JOUR 101 C | Reporting and Writing | 3 |
| PORT 101 C | Elementary Portuguese I | 5 |
| PORT 102 C | Elementary Portuguese II | 5 |
| SPAN 101 C | Elementary Spanish I | 5 |
| SPAN 102 C | Elementary Spanish II | 5 |
| SPAN 201 C | Spanish for Spanish Speakers I | 5 |
| SPAN 202 C | Spanish for Spanish Speakers II | 5 |
| SPAN 203 C | Intermediate Spanish III | 4 |
| SPAN 204 C | Intermediate Spanish IV | 4 |

Total Units Required 19–21

English (ENGL)

ENGL 027 C Basic Study Skills 3 Units

Term hours: 54 lecture. The purpose of this course is to assist students with limited academic backgrounds in experiencing college success by taking responsibility for their college experience. Intensive practice and guidance in campus orientation, goal setting, time management, listening and note taking, textbook reading, concentration, memory strategies, and test taking are provided. Non Degree Credit. Pass/No Pass/Letter Grade Option.

ENGL 057 C Reading and Writing I 4 Units

Prerequisite: Student must have appropriate score on CTEP Assessment.
Term hours: 72 lecture hours. This course is designed for first semester college students and emphasizes basic instruction in reading and writing, including such topics as comprehension, vocabulary development, reading efficiency, study techniques, and basic composition. Individualized instruction is provided. Non Degree Credit. Pass/No Pass/Letter Grade Option.

ENGL 058 C Reading and Writing II 4 Units

Prerequisite: Completion of ENGL 057 C with a “C” or better, or acceptable score on the placement test.
Term hours: 72 lecture. This course is designed to prepare students for ENGL 060 C and for the demands of college reading and writing. It emphasizes a comprehensive approach to reading and writing and includes such topics as: academic comprehension, vocabulary development, and basic academic composition. Individualized instruction is included. Non Degree Credit. Pass/No Pass/Letter Grade Option.

ENGL 060 C College Writing Preparation 4 Units

Prerequisite: Acceptable score on placement test, ENGL 058 C with a grade of “C” or better, or ESL 186 C with a grade of “C” or better.
Term hours: 72 lecture. The focus of this course is reading, critical analysis, and writing expository essays. The course reviews the fundamentals of grammar, sentence structure, and paragraph development. Non Degree Credit. Pass/No Pass/Letter Grade Option.

ENGL 096 C College Reading Strategies 3 Units

Prerequisite: Eligibility for ENGL 060 C or acceptable score on the placement test.
Term hours: 54 lecture. This course prepares students to succeed in college by focusing attention on academic and technical discipline-specific reading strategies and by teaching students how to adapt these active reading skills to college courses and in the workplace. Emphasis is placed on acquiring, applying, adapting, and critically evaluating these crucial reading, writing and study-learning strategies which facilitate optimum learning in the content area classes. These include cross-discipline strategies, as well as writing-to-learn strategies and discipline-specific strategies. Completion of this course satisfies the Cypress College Associate Degree Graduation Reading Proficiency Requirement. Pass/No Pass/Letter Grade Option. (RDG)

ENGL 098 C Language Arts Seminar .5 to 12 Units

Prerequisite: May be required.
Corequisite: May be required.
Advisory: May be required.
Term hours: 0-216 lecture and/or 0-432 laboratory depending on units attempted. This seminar is for students who wish to extend their knowledge of English, reading, and study skills through small group discussion. May be taken for credit 1-4 times. Pass/No Pass or Pass/No Pass/Letter Grade Option or Standard Letter Grade. Fees may be required-Payable at Registration.

ENGL 100 C College Writing 4 Units

Prerequisite: Acceptable score on placement test or ENGL 060 C with a grade of “C” or better, or ESL 186 C with a grade of “C” or better.

Term hours: 72 lecture. This course is a college level course in written communication. It is designed to develop reading, critical thinking, and writing strategies necessary for academic success. The emphasis is on writing expository essays. The course requires the use of research and documentation skills. Duplicate credit not granted for ENGL 100HC. (UC Credit Limitation/CSU, AA GE, CSU GE, IGETC, C-ID: ENGL 100)

ENGL 100HC Honors College Writing 4 Units

Prerequisite: ENGL 060 C with a grade of “C” or better.

Term hours: 72 lecture. This course is a college level course enhanced for Honors students. The emphasis is on reading and writing expository essays. The course will develop increased critical thinking, reading and writing skills. The class will be conducted as a seminar and will require a significant research project that uses correct documentation skills. Duplicate credit not granted for ENGL 100 C. (UC Credit Limitation/CSU, AA GE, CSU GE, IGETC, C-ID: ENGL 100)

ENGL 102 C Introduction to Literature 3 Units

Prerequisite: ENGL 100 C or ENGL 100HC with a grade of “C” or better.

Term hours: 54 lecture. This course is a continuation of ENGL 100 C. It builds from the inferential reading and expository writing of the first semester course to demonstrate reading comprehension as well as composition of the analytical and critical essay. The content introduces students to techniques and major authors of narrative fiction, drama, and poetry, providing them with an opportunity to enrich their lives, enhance their understanding of the human condition, and develop an appreciation of good literature. (UC/CSU, AA GE, CSU GE, IGETC, RDG, C-ID: ENGL 120)

ENGL 102HC Honors Introduction to Literature 3 Units

Prerequisite: ENGL 100 C or ENGL 100HC.

Term hours: 54 lecture. This course is enhanced for honors students. The course is a continuation of ENGL 100 C or ENGL 100HC. It builds from the inferential reading and expository writing of the first semester course to demonstrate reading comprehension as well as composition of the analytical and critical essay. The content introduces students to techniques and major authors of narrative fiction, drama, and poetry, providing them with an opportunity to enrich their lives, enhance their understanding of the human condition, and develop an appreciation of literature. The class is conducted as a seminar and will require additional writing and documented research assignments. Duplicate credit not granted for ENGL 102 C. (UC/CSU, AA GE, CSU GE, IGETC, RDG, C-ID: ENGL 120)

ENGL 103 C Critical Reasoning and Writing 4 Units

Prerequisite: ENGL 100 C or ENGL 100HC with a grade of “C” or better.

Term hours: 72 lecture. This course is designed to develop critical thinking, reading, and writing skills beyond the level achieved in ENGL 100 C. The course will focus on the development of logical reasoning and analytical and argumentative writing skills. (UC/CSU, AA GE, CSU GE, IGETC, RDG, C-ID: ENGL 105)

ENGL 103HC Honors Critical Reasoning and Writing 4 Units

Prerequisite: ENGL 100 C or ENGL 100HC with grades of “C”.

Term hours: 72 lecture. ENGL 103HC is a college level course enhanced for Honors students. This course is designed to develop critical thinking, reading, and writing skills beyond the level achieved in ENGL 100 C. The course will focus on the enhanced development of logical reasoning and analytical and argumentative writing skills. Writing expanded argumentative research essays, and utilizing enhanced research strategies and documentation skills will be required. Duplicate credit not granted for ENGL 103 C. (UC/CSU, AA GE, CSU GE, IGETC, C-ID: ENGL 105)

ENGL 104 C Critical Analysis and Literature 4 Units

Prerequisite: ENGL 100 C with a grade of “C” or better.

Term hours: 72 lecture. This course will develop critical thinking, reading, and writing skills as they apply to the analysis of literature and literary criticisms from diverse cultural sources and perspectives. There will be an emphasis on the techniques and principles of effective written argument as they apply to literature. Students will demonstrate this understanding by writing and critiquing essays and utilizing research strategies. Duplicate credit not granted for ENGL 104HC. (UC Credit Limitation/CSU, AA GE, CSU GE, IGETC, RDG, C-ID: ENGL 110)

ENGL 104HC Honors Critical Analysis and Literature 4 Units

Prerequisite: ENGL 100 C or ENGL 100HC with a grade of “C” or better.

Term hours: 72 lecture. This course is a college level course enhanced for honors students. The emphasis is on developing increased critical thinking, reading, and writing skills as they apply to the analysis of literature and literary criticism. Writing expanded argumentative research essays and utilizing enhanced research strategies and documentation skills will be required. The class will be conducted as a seminar. Duplicate credit not granted for ENGL 104 C. (UC Credit Limitation/CSU, AA GE, CSU GE, IGETC, RDG, C-ID: ENGL 110)

ENGL 105 C Creative Writing 3 Units

Prerequisite: ENGL 100 C or ENGL 100HC with a minimum grade of “C”.

Advisory: ENGL 102 C.

Term hours: 54 lecture. This class provides an opportunity for students to write short fiction, poetry, and, optionally, a short play. Students will gain an understanding of each literary type, create material in each area, and have their work critiqued in a workshop setting. (UC/CSU, C-ID: ENGL 200)

ENGL 106 C Critical Reading, Writing and Thinking 3 Units

Prerequisite: ENGL 100 C or ENGL 100HC with minimum grades of “C”.

Term hours: 54 lecture. This course develops critical reading, writing and thinking skills. Emphasis is placed on learning the critical reading strategies necessary to analyze and evaluate rhetorical and logical elements of written communication. (UC/CSU, AA GE, CSU GE, IGETC, RDG)

ENGL 108 C Writing the Personal Statement .5 Units

Prerequisite: ENGL 100 C or ENGL 100HC.

Term hours: 9 lecture. This course will teach students how to write an effective personal statement on their transfer applications to four-year institutions. Content strategies and essay format will be discussed, and opportunities for multiple drafts will be engaged. Pass/No Pass only. (CSU)

ENGL 110 C Humanities: Ancient and Medieval 3 Units

Prerequisite: Eligibility for ENGL 100 C.

Term hours: 54 lecture. This course is a survey of the development of Western culture with a focus upon its Greco-Roman roots, and a study of other important influences, including African and Middle Eastern. The course covers prehistory to the Renaissance, with an emphasis on the arts. Cost for museum visits not to exceed \$15.00. (UC/CSU, AA GE, CSU GE, IGETC)

ENGL 111 C Humanities: Renaissance-Present 3 Units

Same as INDS 101 C

Prerequisite: Eligibility for ENGL 100 C.

Term hours: 54 lecture. This course is a survey of the development of Western culture from the Renaissance to the present, including a study of other important influences from Africa, the Middle East, and North and South America, with emphasis on the arts. Duplicate credit not granted for INDS 101 C. Cost for museum visits not to exceed \$15.00. (UC/CSU, AA GE, CSU GE, IGETC)

ENGL 117 C Academic Reading and Study Strategies**1 Unit**

Term hours: 18 lecture. This course helps students improve comprehension of reading materials related to a designated college-level content-area course through the development of discipline-specific vocabulary, academic reading strategies, critical analysis of reading materials, and academic success skills specific to that course. Content-area courses vary by semester. (CSU)

ENGL 125 C The Film**3 Units***Prerequisite: ENGL 100 C.*

Term hours: 54 lecture. This course is a critical study of film that will develop critical thinking and writing skills. Students will study the elements of film making and the historical development of film. Film as a story telling art form will be emphasized. Ten to twelve films will be shown in class for analysis and discussion. Students will be expected to watch and study several additional films outside of class. Duplicate credit not granted for ENGL 125HC. (UC Credit Limitation/CSU, AA GE, CSU GE, IGETC)

ENGL 125HC Honors Film**3 Units***Prerequisite: ENGL 100 C or ENGL 100HC with a minimum grade of "C".*

Term hours: 54 lecture. This course is a critical study of film as a story telling art form enhanced for Honors students. Students study the elements of cinematic storytelling, film's dependence on literature, and the historical development of film. Ten to twelve short and feature films are shown in the course for discussion and analysis. Students will be expected to watch and study several additional films outside of class. The course is taught in a seminar format. Duplicate credit not granted for ENGL 125 C. (UC Credit Limitation/CSU, AA GE, CSU GE, IGETC)

ENGL 126 C Screenwriting**3 Units***Prerequisite: ENGL 100 C or ENGL 100HC with a minimum grade of "C".*

Term hours: 54 lecture. This course provides students the opportunity to study the art of the screenplay and create their own. Students will critically analyze professional models, view excellent examples of film writing, and work on their own screenplay. Students will have the opportunity to have their work critiqued in a workshop setting. (UC/CSU, AA GE)

ENGL 127 C Introduction to Poetry Writing**3 Units***Prerequisite: ENGL 100 C or ENGL 100HC with a minimum grade of "C".*

Term hours: 54 lecture. Students will write original poetry, study forms, techniques, and literary elements of poetry, including classical poetic forms and free-verse tradition. Student work will be critiqued in a workshop setting. (UC/CSU, AA GE, CSU GE pending)

ENGL 135 C Grammar and Usage**3 Units***Prerequisite: Eligibility for ENGL 100 C.*

Term hours: 54 lecture. This is a course in English grammar and usage. Students will learn about the origins and development of the English language. Parts of speech, parts of sentences, verb tenses, sentence types, syntax, and standard usage will be emphasized. Students will demonstrate their understanding of English grammar and usage by analyzing standard written English. This course is useful for English, journalism, foreign language, and court reporting students and especially for those planning to enter elementary or secondary teaching. (CSU, AA GE)

ENGL 137 C College Study Strategies**3 Units***Prerequisite: ENGL 060 C.*

Term hours: 54 lecture. The purpose of this course is to assist students in mastering effective learning and critical thinking strategies crucial for academic success and professional and personal growth. Goal setting and motivation, learning styles, time management, stress management, academic and professional reading, reading rate improvement, listening for note-taking, concentration, memory, test preparation, and test-taking strategies are primary topics. Pass/No Pass/Letter Grade Option. (CSU)

ENGL 208 C Asian American Literature**3 Units***Prerequisite: ENGL 100 C or ENGL 100HC with a minimum grade of "C".*

Term hours: 54 lecture. This course is a study of Asian American literature. Students will explore and analyze a variety of social and political issues, such as gender relationships, family relationships, cultural traditions, cultural conflicts, culinary traditions, and stereotypes from an Asian American perspective. This course is designed to enhance cultural awareness and understanding, while also facilitating personal enrichment through the exploration of a variety of literary sources, including fiction, drama, poetry, journals, biography, and film. (UC/CSU, AA GE, CSU GE, IGETC, CUL DIV)

ENGL 211 C English Literature to 1760**3 Units***Prerequisite: ENGL 100 C or ENGL 100HC.**Advisory: ENGL 102 C.*

Term hours: 54 lecture. The course is an introduction to the major periods and movements, major authors, and major forms from the beginning of English literature to 1760. It covers works such as Beowulf and Sir Gawain and the Green Knight, as well as works from authors such as Marie de France, Chaucer, Marlowe, Shakespeare, Donne, Milton, Pope, and Swift. (UC/CSU, AA GE, CSU GE, IGETC, C-ID: ENGL 160)

ENGL 212 C English Literature Since 1760**3 Units***Prerequisite: ENGL 100 C or ENGL 100HC.**Advisory: ENGL 102 C.*

Term hours: 54 lecture. The course is an introduction to the major periods and movements, major authors, and major forms from 1760 to the present. It considers literary trends and historical backgrounds from the Romantic, Victorian, Modern, and Postmodern eras. It covers fiction, poetry, drama, and prose from such authors as Wollstonecraft, Blake, Wordsworth, Coleridge, Byron, Shelley, Keats, Browning, Dickens, Wilde, Joyce, Hopkins, Yeats, Eliot, Woolf, and Beckett. (UC/CSU, AA GE, CSU GE, IGETC, C-ID: ENGL 165)

ENGL 221 C American Literature to 1865**3 Units***Prerequisite: ENGL 100 C or ENGL 100HC.**Advisory: ENGL 102 C.*

Term hours: 54 lecture. This course is a survey of the literature of American writers from the Colonial Period to 1865. It is designed to increase understanding and appreciation of the development of American culture and literary achievements. A diversity of writings will be included to reflect the various subjects and styles that comprise the development of American Literature. (UC/CSU, AA GE, CSU GE, IGETC, C-ID: ENGL 130)

ENGL 222 C American Literature Since 1865**3 Units***Prerequisite: ENGL 100 C or ENGL 100HC.**Advisory: ENGL 102 C.*

Term hours: 54 lecture. This course is a survey of the literature of American writers from 1865 to the present. It is designed to increase understanding and appreciation of the development of American culture and literary achievements. A diversity of writings will be included to reflect the various subjects and styles that comprise the development of American Literature. (UC/CSU, AA GE, CSU GE, IGETC, C-ID: ENGL 135)

ENGL 225 C Literary Journal Publications**3 Units***Prerequisite: ENGL 100 C with a minimum grade of "C".*

Term hours: 54 lecture. This course provides instruction and experience in literary journal editing and publication. Students will solicit, select, proof-read, and edit submissions in fiction and creative non-fiction for the Cypress College magazines Sole Image and Gendersmash. Students will design and compose layout, oversee the editing and printing process, and coordinate distribution. (CSU)



ENGL 234 C Shakespeare 3 Units*Prerequisite: ENGL 100 C or ENGL 100HC with a minimum grade of "C".*

Term hours: 54 lecture. The course is an introduction to the major works of William Shakespeare. The emphasis is upon the plays and includes a study of selected comedies, histories, and the major tragedies. Ten to twelve plays will be studied along with a selection of the sonnets. Duplicate credit not granted for ENGL 234HC. (UC Credit Limitation/CSU, AA GE, CSU GE, IGETC)

ENGL 234HC Honors Shakespeare 3 Units*Prerequisite: ENGL 100 C or ENGL 100HC with a minimum grade of "C".*

Term hours: 54 lecture. This is a college level course enhanced for Honors students. The emphasis is on developing increased critical thinking, reading, and writing skills as they apply to an analysis of William Shakespeare's sonnets and his major plays, both as texts and in performance. The class will be conducted as a seminar. Duplicate credit not granted for ENGL 234 C. (UC Credit Limitation/CSU, AA GE, CSU GE, IGETC)

ENGL 239 C Survey - Children's Literature 3 Units*Prerequisite: Completion of ENGL 100 C or ENGL 100HC with a grade of "C" or better.*

Term hours: 54 lecture. This course surveys the historical and cultural development of children's literature throughout the world, while emphasizing the important role that literature must assume in the social, emotional, and intellectual development of children. Tracing the multicultural origins of the oral tradition to the current standards of written excellence and pictorial artistry, this course concentrates on nursery rhymes, poetry, folk tales, myth, sacred literature, picture books, juvenile literature, and non-fiction. Comparative and critical approaches are used to analyze children's literature from a multicultural perspective. (UC/CSU, AA GE, CSU GE, CUL DIV, C-ID: ENGL 180)

ENGL 243 C Mythology 3 Units*Prerequisite: ENGL 100 C with a minimum grade of "C".*

Term hours: 54 lecture. This course is an introductory study of the mythology and folklore of the world including such cultures as Egyptian, Babylonian, Greek, Norse, Hindu, Chinese, Scandinavian, Native American, Central and South American, and African. This course will include a comparative study of mythic elements and patterns with their modern parallels. (UC/CSU, AA GE, CSU GE, IGETC)

ENGL 247 C Multicultural Literature 3 Units*Prerequisite: ENGL 100 C or ENGL 100HC.*

Term hours: 54 lecture. This is a survey course on the ethnic American experience in the United States, focusing primarily on the works of Native American, African American, Latino, and Asian American authors. Literary genres will include poetry, drama, short fiction, and expository writing, as well as tales, chants, and rituals. Literary works will be examined within their cultural, historical, and social frameworks. Students will explore the role of race, ethnic identity, class, gender, and sexual orientation in identity formation, evaluating the collision/interaction between cultures. The course is designed to enrich students' lives by exploring the multicultural literary sources of America that contribute to the cultural history and development of contemporary American society. Duplicate credit not granted for ENGL 097 C. (UC/CSU, AA GE, CSU GE, IGETC, CUL DIV)

ENGL 255 C African-American Literature I 3 Units*Prerequisite: ENGL 100 C or ENGL 100HC with a grade of "C" or better.*

Term hours: 54 lecture. This course is an in-depth historical analysis of the African and African-American literary diaspora, which explores autobiography, letters, poems, narratives, prose and other folk traditions from the beginning of the slave era to the Reconstruction era in the United States. This course is designed to expose students to the literature and social issues of Africans in America. (UC/CSU, AA GE, CSU GE, IGETC, CUL DIV)

ENGL 256 C African-American Literature II 3 Units*Prerequisite: ENGL 100 C or ENGL 100HC with a grade of "C" or better.*

Term hours: 54 lecture. This course is an in-depth historical analysis of the African and African American literary diaspora, which explores autobiography, letters, poems, plays, prose and other folk traditions from the Civil War to present in the United States. This course is designed to expose students to the literature and social issues of Africans in America. (UC/CSU, AA GE, CSU GE, IGETC, CUL DIV)

ENGL 260 C Survey of Arabic Literature 3 Units*Prerequisite: ENGL 100 C or ENGL 100HC with minimum grades of "C".*

Term hours: 54 lecture. This course is a survey of Arabic literature in translation. Students will explore and analyze many of the social, political, and cultural issues through a focus on continuity and change, influence, and major trends. This course is designed to provide students with a foundational knowledge of Arabic literature in translation and enhance cultural awareness and understanding, while also facilitating personal enrichment through the exploration of a variety of literary sources, including fiction, drama, and poetry. (UC/CSU, AA GE, CSU GE, IGETC)

ENGL 298 C Language Arts Seminar .5 to 12 Units

Term hours: 9-216 lecture depending on units attempted. This seminar is for able students who wish to extend their knowledge of literature, language and culture through small group discussion. Subject matter may concern the work of one author or the literary or cultural characteristics of a particular movement or period. May be taken for credit 1-4 times. Pass/No Pass or Pass/No Pass/Letter Grade Option or Standard Letter Grade. (UC Credit Limitation/CSU)

ENGL 299 C Language Arts Independent Study .5 to 2 Units*Prerequisite: Approved Independent Study Learning Contract.*

Term hours: 9-36 conference depending on units attempted. This course is for students who wish to increase their knowledge of literature and/or language through individual study or research. Unit credit may range from 1/2 to 2 units in any given semester. May be taken for credit 3 times. (UC Credit Limitation/CSU)

ENGL 310 C Advanced Writing in the Health Sciences 3 Units*Prerequisite: ENGL 100 C or ENGL 100HC.*

Term Hours: 72 lecture. This course provides an overview of writing for students in health sciences. It will include effective workplace/professional writing and critical evaluation of discipline specific texts. The class will also include research writing, grant writing and appropriate documentation skills. This course is designed for science majors. Enrollment limited to those accepted into the baccalaureate degree pilot program.

English as a Second Language (ESL)

Division of Language Arts

Division Dean — Eldon Young

Faculty

Jill Bauer

Jenelle Herman

Alison Robertson

Samantha Simmons

Kathryn Wada

Counselors

Therese Mosqueda-Ponce

Daniel Pelletier

PROGRAM LEARNING OUTCOMES (PLOs)

The courses taught by this department contribute to the General Education and Basic Skills Program Learning Outcomes. Please refer to General Education and Basic Skills Program Learning Outcomes.

English as a Second Language (ESL)

ESL 044 C Low Intermediate Academic Oral Skills 2 Units

Prerequisite: Appropriate skills demonstrated through the assessment process.

Term hours: 36 lecture. This course is designed for low intermediate level non-native speakers of English (NNS) to improve basic oral communication skills related to academic and social contexts. The emphasis is on conversation, small group discussion, class discussion, and listening comprehension. Non-Degree Credit. Pass/No Pass/Letter Grade Option.

ESL 051 C Intermediate Pronunciation 2 Units

Prerequisite: Appropriate skills demonstrated through the assessment process.

Term hours: 36 lecture. This course is designed to refine pronunciation, to reduce foreign accent, and to build confidence in oral expression. Recommended for all non-native students. Non-Degree Credit. Pass/No Pass/Letter Grade Option.

ESL 052 C Intermediate ESL Grammar 1 3 Units

Prerequisite: Completion of ESL 081 C or appropriate skills demonstrated through the assessment process.

Term hours: 54 lecture. This course is designed for intermediate academic ESL students to increase their knowledge and usage of English grammar with particular emphasis on verb tense, verb form, verbals and verb phrase structure in writing. Non-Degree Credit. Pass/No Pass/Letter Grade Option.

ESL 053 C Intermediate ESL Grammar 2 3 Units

Prerequisite: Completion of ESL 081 C or appropriate skills demonstrated through the assessment process.

Term hours: 54 lecture. This course is designed for intermediate academic ESL students to increase their knowledge and use of English with particular emphasis on sentence parts, sentence types, punctuation and editing skills in writing. Non-Degree Credit. Pass/No Pass/Letter Grade Option.

ESL 054 C Intermediate Academic Oral Skills NNS 2 Units

Prerequisite: Completion of ESL 080 C or appropriate skills demonstrated through the assessment process.

Term hours: 36 lecture. This course is designed for intermediate level non-native English speakers (NNS) to improve oral communication skills related to academic and social contexts. The emphasis is on small group and class discussion, formal and informal presentations, and listening comprehension. Non-Degree Credit. Pass/No Pass/Letter Grade Option.

ESL 062 C Advanced ESL Grammar 1 3 Units

Prerequisite: Completion of ESL 183 C or appropriate skills demonstrated through the assessment process.

Term hours: 54 lecture. This course is designed for advanced academic ESL students to increase their knowledge and use of English with particular emphasis on advanced verb tense, verb form, verbals, verb phrase structure and editing skills in writing. Non-Degree Credit. Pass/No Pass/Letter Grade Option.

ESL 063 C Advanced ESL Grammar 2 3 Units

Prerequisite: Completion of ESL 183 C or appropriate skills demonstrated through the assessment process.

Term hours: 54 lecture. This course is designed for advanced ESL students to increase knowledge and use of English with emphasis on sentence parts, advanced sentence structure, punctuation and editing skills in writing. Non-Degree Credit. Pass/No Pass/Letter Grade Option.

ESL 064 C Advanced Academic Oral Skills NNS 2 Units

Prerequisite: Completion of ESL 183 C or appropriate skills demonstrated through the assessment process.

Term hours: 36 lecture. This course is designed for advanced level non-native speakers of English (NNS) to improve listening and speaking skills related to academic contexts. The emphasis is lecture note-taking, informal and formal speeches, and small group and class discussion. Non-Degree Credit. Pass/No Pass/Letter Grade Option.

ESL 066 C Advanced ESL Reading 3 Units

Prerequisite: ESL 183 C with a minimum grade of "C" or appropriate skills demonstrated through the assessment process.

Term hours: 54 lecture. This reading skills course is designed for non-native speaking students eligible for advanced ESL courses who need to improve their college academic and non-academic reading skills. It does not meet the reading proficiency requirement for the AA degree. Non-Degree Credit. Pass/No Pass/Letter Grade Option.

ESL 080 C Low Intermediate Academic Reading/Writing 1 5 Units

Prerequisite: Appropriate skills demonstrated through the assessment process.

Term hours: 90 lecture. This is a low intermediate level one integrated skills course designed to improve the academic reading, writing, grammar and interpersonal communication skills of non-native speakers. Non-Degree Credit. Pass/No Pass/Letter Grade Option.

ESL 081 C Low Intermediate Academic Reading/Writing 2 5 Units

Prerequisite: ESL 080 C with a grade of "C" or appropriate skills demonstrated through the assessment process.

Term hours: 90 lecture. This is a low intermediate level two integrated skills course designed to improve the academic reading, writing, grammar, and interpersonal communication skills of non-native speakers. Non-Degree Credit. Pass/No Pass/Letter Grade Option.

Flow Chart for Academic ESL Courses at Cypress College

Courses

Are you a non-native speaker of English? If so, then the CELSA (the ESL placement test) is the right test to evaluate your language skills. You should take the CELSA if ...

- ... you were born in a non-English speaking country; and
- ... you started in the U.S. school system in the 7th-12th grade OR as an adult.

The CELSA test is designed to measure the English skills of non-native speakers of English and is required for proper placement in English as a Second Language (ESL) courses. The CTEP test is designed for native speakers of English and may NOT be substituted for placement in ESL courses.

However, students scoring high on the CELSA test may be referred to English 100 after writing a successful composition.

The ESL courses at Cypress College are designed to build the academic skills of non-native speakers of English as they prepare for college-level coursework, certificate programs, or other professional goals.

Students enrolled in core courses will be required to write a composition or other written evaluation on the first day of instruction to verify skill level and appropriate placement in the ESL sequence of courses.

Students with appropriate scores on the CELSA test may be advised to take ESL courses and elective courses at different levels in order to build specific skill areas.

ADVANCED ELECTIVES

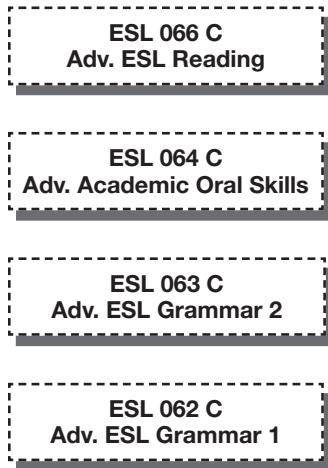

INTERMEDIATE ELECTIVES

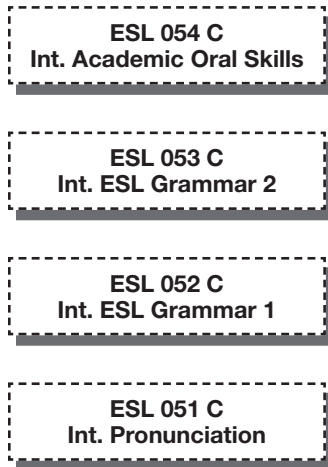

ESL CORE CLASSES

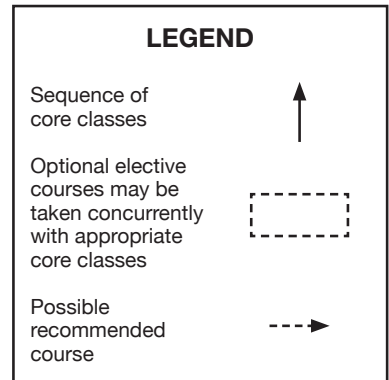
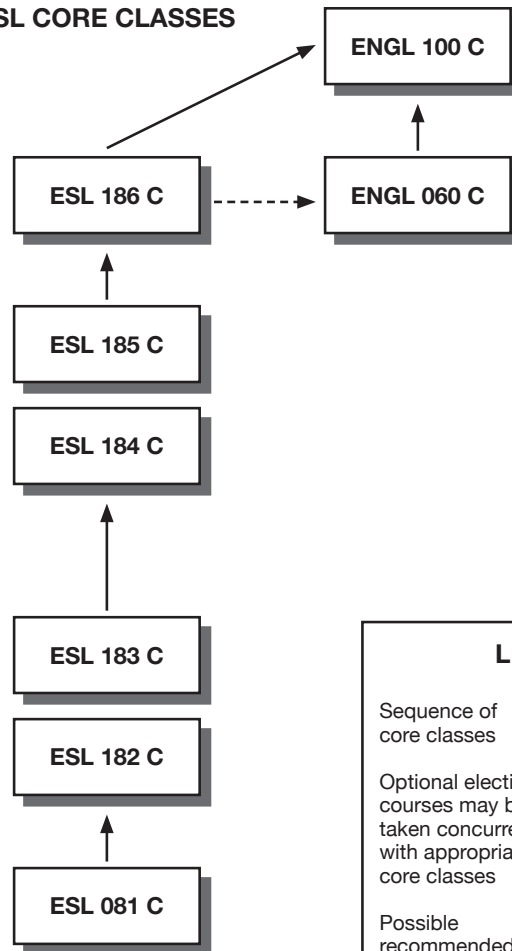

ESL 098 C ESL Seminar/Non-Native Speakers .5 to 12 Units*Prerequisite: May be required.**Corequisite: May be required.**Advisory: May be required.*

Term hours: 0-216 lecture and/or 0-432 laboratory depending on units attempted. This seminar is for qualified students who wish to extend their knowledge of literature, language, and culture through small groups discussion. Fees may be required-Payable at Registration. Pass/No Pass/Letter Grade Option.

ESL 099 C Independent Study/Non-Native Speakers .5 to 2 Units*Prerequisite: Approved Independent Study Learning Contract.*

Term hours: Two hours conference per week and appropriate number of laboratory hours for maximum credit. This is a course designed for advanced ESL students who have completed all regular courses and wish to pursue additional coursework in one or more of the language skills: listening, speaking, reading, writing and/or culture. Pass/No Pass only.

ESL 182 C Intermediate Academic Reading/Writing 5 Units

Formerly ESL 082 C

Prerequisite: ESL 081 C with a minimum grade of "C" or appropriate skills demonstrated through the assessment process.

Term hours: 90 lecture. This is an intermediate integrated skills course designed to improve the academic reading, writing, grammar, and interpersonal communication skills of non-native speakers. (CSU)

ESL 183 C High Intermediate Academic Reading/Writing 5 Units

Formerly ESL 083 C

Prerequisite: ESL 182 C with a minimum grade of "C" and appropriate skills demonstrated through the assessment process.

Term hours: 90 lecture. This course is a high intermediate integrated skills course designed to improve the academic reading, writing, grammar, and interpersonal communication skills of non-native speakers. (CSU)

ESL 184 C Advanced Academic Reading/Writing 1 5 Units*Prerequisite: ESL 183 C with a minimum grade of "C" or appropriate skills demonstrated through the assessment process.*

Term hours: 90 lecture. This course is the first in a series of advanced integrated ESL skills course designed to improve the academic reading, writing, grammar, and interpersonal communication skills of non-native speakers. (UC Credit Limitation/CSU)

ESL 185 C Advanced Academic Reading/Writing 2 5 Units*Prerequisite: ESL 184 C with a minimum grade of "C" or appropriate skills demonstrated through the assessment process.*

Term hours: 90 lecture. This course is the second in a series of advanced integrated ESL skills course designed to improve the academic reading, writing, grammar, and interpersonal communication skills of non-native speakers. (UC Credit Limitation/CSU)

ESL 186 C College Writing Preparation for Non-Native Speakers 5 Units*Prerequisite: ESL 185 C with a grade of "C" or appropriate skills demonstrated through the assessment process.*

Term hours: 90 lecture. This course is designed for the non-native speaker of English for development of college level writing skills. Emphasis is on essay development of expository writing in connection with advanced readings from various sources and a novel. The fundamentals of English written expression are reviewed with emphasis on standard American usage problematic to the non-native student. The course is designed to prepare students for ENGL 100 C. (UC Credit Limitation/CSU)

ESL 298 C English as a Second Language Seminar .5 to 12 Units*Prerequisite: May be required.**Corequisite: May be required.**Advisory: May be required.*

Term hours: 0-216 lecture and/or 0-432 laboratory depending on units attempted. This seminar is for able students who wish to extend their knowledge of literature, language and culture through small group discussion. Fees may be required-Payable at Registration. Pass/No Pass/Letter Grade Option. (UC Credit Limitation/CSU)

Ethnic Studies

Division of Social Sciences

Division Dean — Lisa Gaetje, Interim*Faculty*

Steven Estrada

Daniel Lind

Counselors

Therese Mosqueda-Ponce

Daniel Pelletier

PROGRAM LEARNING OUTCOMES (PLOs)

The courses taught by this department contribute to the General Education and Basic Skills Program Learning Outcomes. Please refer to General Education and Basic Skills Program Learning Outcomes.

ASSOCIATE IN ARTS DEGREE

AFRICAN-AMERICAN STUDIES

Program Code: 1A19682

The Associate in Arts Degree in African-American Studies is designed to provide students with a multi-disciplinary and interdisciplinary examination of the experiences of persons of African descent in the United States. Students will analyze issues pertaining to the African-American community in particular while holistically developing a critical understanding of race, ethnicity, class, and gender in American society.

To earn an Associate Degree students must complete: (1) all major course requirements with a minimum grade of "C"; (2) California State University General Education Breadth requirements (CSU GE Breadth) or IGETC general education plan; (3) any elective courses to complete a minimum of 60 units; (4) complete all graduation requirements; and (5) have an overall GPA of 2.0. At least 50% of all major course work must be completed at Cypress College. Students pursuing more than one specified departmental/area major may double count a maximum of 7 units to fulfill major requirements. Courses that fulfill major requirements for an Associate Degree at Cypress College might not be the same as those required for completing the major at a transfer institution offering a Baccalaureate Degree. For information on specific university requirements, please consult with your counselor, or visit the Transfer Center.

| Required courses (12 units): | | Units |
|--|--|--------------|
| ETHS 101 C | American Ethnic Studies | 3 |
| | or | |
| ETHS 101HC | Honors American Ethnic Studies | (3) |
| ETHS 129 C | Introduction to African-American Studies | 3 |
| ETHS 130 C | African-American History I | 3 |
| ETHS 131 C | African-American History II | 3 |
| Three (3) units from the following elective courses related to the African-American experience: | | Units |
| ENGL 255 C | African-American Literature I | 3 |
| ENGL 256 C | African-American Literature II | 3 |
| ETHS 235 C | The Civil Rights Movement | 3 |
| HIST 135 C | History of Africa | 3 |
| MUS 113 C | Jazz History | 3 |
| POSC 209 C | Urban Politics | 3 |
| Three (3) units from the following elective courses: | | Units |
| ETHS 150 C | Introduction to Chicana/o Studies | 3 |
| ETHS 151 C | Chicana/o History I | 3 |
| ETHS 152 C | Chicana/o History II | 3 |
| ETHS 153 C | Chicana/o Contemporary Issues | 3 |
| ETHS 160 C | Native American History | 3 |
| ETHS 170 C | Introduction to Asian Pacific American Studies | 3 |
| ETHS 171 C | Asian Pacific American History | 3 |
| Total Units Required | | 18 |

ASSOCIATE IN ARTS DEGREE CHICANA/O STUDIES **Program Code: 1A19606**

The Associate in Arts Degree in Chicana/o Studies is designed to provide students with a multi-disciplinary and interdisciplinary examination of the experiences of persons of Mexican descent in the United States. Students will analyze issues pertaining to the Chicana/o (Mexican-American) community in particular while holistically developing a critical understanding of race, ethnicity, class, and gender in American society.

To earn an Associate Degree students must complete: (1) all major course requirements with a minimum grade of "C"; (2) California State University General Education Breadth requirements (CSU GE Breadth) or IGETC general education plan; (3) any elective courses to complete a minimum of 60 units; (4) complete all graduation requirements; and (5) have an overall GPA of 2.0. At least 50% of all major course work must be completed at Cypress College. Students pursuing more than one specified departmental/area major may double count a maximum of 7 units to fulfill major requirements. Courses that fulfill major requirements for an Associate Degree at Cypress College might not be the same as those required for completing the major at a transfer institution offering a Baccalaureate Degree. For information on specific university requirements, please consult with your counselor, or visit the Transfer Center.

| Required courses (15 units): | | Units |
|-------------------------------------|-----------------------------------|--------------|
| ETHS 101 C | American Ethnic Studies | 3 |
| | or | |
| ETHS 101HC | Honors American Ethnic Studies | (3) |
| ETHS 150 C | Introduction to Chicana/o Studies | 3 |
| ETHS 151 C | Chicana/o History I | 3 |
| ETHS 152 C | Chicana/o History II | 3 |
| ETHS 153 C | Chicana/o Contemporary Issues | 3 |

| Three (3) units from the following elective courses: | | Units |
|---|--|--------------|
| ANTH 225 C | Cultures of Mesoamerica | 3 |
| ART 216 C | Latin American Art | 3 |
| ETHS 129 C | Introduction to African-American Studies | 3 |
| ETHS 130 C | African-American History I | 3 |
| ETHS 131 C | African-American History II | 3 |
| ETHS 160 C | Native American History | 3 |
| ETHS 170 C | Introduction to Asian Pacific American Studies | 3 |
| ETHS 171 C | Asian Pacific American History | 3 |
| HIST 142 C | History of Latin America I | 3 |
| HIST 143 C | History of Latin America II | 3 |
| HIST 162AC | History of the Americas I | 3 |
| HIST 162BC | History of the Americas II | 3 |
| HIST 163 C | History of Mexico | 3 |
| HIST 275 C | History of California | 3 |
| Total Units Required | | 18 |

ASSOCIATE IN ARTS DEGREE ETHNIC STUDIES **Program Code: 1A03807**

The Associate in Arts Degree in Ethnic Studies is designed to provide students with a comparative, multi-disciplinary, and interdisciplinary understanding of the experiences of African Americans, Asian Pacific Americans, Chicanos/Latinos, and Native Americans. Students study the histories, cultures, literatures, and politics of communities of color in the United States so that they can critically analyze issues pertaining to race, ethnicity, class, and gender while developing an appreciation for the cultural diversity of American society.

To earn an Associate Degree students must complete: (1) all major course requirements with a minimum grade of "C"; (2) California State University General Education Breadth requirements (CSU GE Breadth) or IGETC general education plan; (3) any elective courses to complete a minimum of 60 units; (4) complete all graduation requirements; and (5) have an overall GPA of 2.0. At least 50% of all major course work must be completed at Cypress College. Students pursuing more than one specified departmental major may double count a maximum of 7 units to fulfill major requirements. Courses that fulfill major requirements for an Associate Degree at Cypress College might not be the same as those required for completing the major at a transfer institution offering a Baccalaureate Degree. For information on specific university requirements, please consult with your counselor, or visit the Transfer Center.

| Required courses (15 units): | | Units |
|-------------------------------------|--|--------------|
| ETHS 101 C | American Ethnic Studies | 3 |
| | or | |
| ETHS 101HC | Honors American Ethnic Studies | (3) |
| ETHS 129 C | Introduction to African-American Studies | 3 |
| ETHS 150 C | Introduction to Chicana/o Studies | 3 |
| ETHS 160 C | Native American History | 3 |
| ETHS 170 C | Introduction to Asian Pacific American Studies | 3 |

| Three (3) units from the following elective courses: | Units |
|---|--------------|
| ANTH 121 C | 3 |
| ANTH 225 C | 3 |
| ART 216 C | 3 |
| ENGL 208 C | 3 |
| ENGL 247 C | 3 |
| ENGL 255 C | 3 |
| ENGL 256 C | 3 |
| ETHS 130 C | 3 |
| ETHS 131 C | 3 |
| ETHS 151 C | 3 |
| ETHS 152 C | 3 |
| ETHS 153 C | 3 |
| ETHS 171 C | 3 |
| ETHS 235 C | 3 |
| HIST 135 C | 3 |
| HIST 142 C | 3 |
| HIST 143 C | 3 |
| HIST 160 C | 3 |
| HIST 161 C | 3 |
| HIST 163 C | 3 |
| HIST 275 C | 3 |
| POSC 209 C | 3 |
| PSY 131 C | 3 |
| THEA 107 C | 3 |
| THEA 107HC | (3) |
| Total Units Required | 18 |

ETHNIC STUDIES TRANSFER PROGRAM

Students should consult a counselor or www.assist.org for lower division major requirements for most California public universities. (See the Standard Definitions section of the catalog for a description of ASSIST.) Students transferring to an independent college/university should consult the catalog of the individual school and a counselor for lower division major requirements.

Ethnic Studies (ETHS)

ETHS 101 C American Ethnic Studies 3 Units
Advisory: Eligibility for ENGL 100 C.
 Term hours: 54 lecture. This course serves to broaden the ethnic and racial perspective of students interested in American culture and society. It encompasses a historical overview of the social, cultural, political, and economic aspects of four ethnic groups -- Native Americans, African Americans, Chicanos, and Asian Pacific Americans -- in the United States. Emphasis is placed on the historical and contemporary relationships of these groups with each other and the rest of American society. Duplicate credit not granted for ETHS 101HC. (UC Credit Limitation/CSU, AA GE, CSU GE, IGETC, CUL DIV, C-ID: SOCI 150)

ETHS 101HC Honors American Ethnic Studies 3 Units
Advisory: Eligibility for ENGL 100 C.
 Term hours: 54 lecture. This course serves to broaden the ethnic and racial perspective of students interested in American culture and society. It is an enhanced historical study of the social, cultural, political, and economic aspects of four ethnic groups -- Native Americans, African Americans, Chicanos, and Asian Pacific Americans -- in the United States. Emphasis is placed on the historical and contemporary relationships of these groups with each other and the rest of American society. Duplicate credit not granted for ETHS 101 C. (UC Credit Limitation/CSU, AA GE, CSU GE, IGETC, CUL DIV, C-ID: SOCI 150)

ETHS 129 C Introduction to African-American Studies 3 Units
Advisory: Eligibility for ENGL 100 C.
 Term hours: 54 lecture. This course is an introduction to the field of African-American Studies. An interdisciplinary approach will be employed to study the various experiences of African Americans and their contributions to American society and culture. The course will cover historical and contemporary issues, including African origins, the development of African-American culture, the struggles of the black family, black political life, and the socio-economic empowerment of black people in the United States. (UC/CSU, AA GE, CSU GE, IGETC, CUL DIV)

ETHS 130 C African-American History I 3 Units
Advisory: Eligibility for ENGL 100 C.
 Term hours: 54 lecture. This course is a survey of the African-American experience in the United States from its African roots through the American Civil War, emphasizing the roles of African Americans in the political, social, and economic development of American society. Topics covered include: the trans-Atlantic slave trade; the process of enslavement in the Americas; slave life and resistance; the socio-economic conditions of free blacks; the politico-economic dispute regarding slavery and its consequences in the outbreak of the American Civil War; and the emancipation of the enslaved black population. (UC/CSU, AA GE, CSU GE, IGETC, CUL DIV)

ETHS 131 C African-American History II 3 Units
Advisory: Eligibility for ENGL 100 C.
 Term hours: 54 lecture. This course is a survey of the African-American experience in the United States from the Era of Reconstruction to the present, emphasizing the roles of African Americans in the political, social and economic development of American society. Topics covered include: the various phases of the Reconstruction period; black life in the "New South"; the debates over educational and socio-economic progress; the migrations to the North and West; the struggles of the black working class; the impact of the two world wars on black life; the Civil Rights Movement; militancy during the 1960s; and the black experience in contemporary America. (UC/CSU, AA GE, CSU GE, IGETC, CUL DIV)

ETHS 150 C Introduction to Chicana-o Studies 3 Units
Advisory: Eligibility for ENGL 100 C.
 Term hours: 54 lecture. This course is an introduction to the field of Chicana/o Studies. It is designed to acquaint students with the most significant social, political, economic, and historical aspects of the Chicana/o experience in the United States. As such, the course is interdisciplinary in nature and critically analyzes the societal content in which Chicanas/os have sought to maintain their culture. (UC/CSU, AA GE, CSU GE, IGETC, CUL DIV)

ETHS 151 C Chicana-o History I 3 Units
Advisory: Eligibility for ENGL 100 C.
 Term hours: 54 lecture. This course is a survey of the Chicana/o experience from the pre-European conquest era of North America to the Mexican-American War. Topics covered include: Mesoamerican civilizations; Spanish conquest and settlement in the Americas; the African presence in New Spain; "mestizaje", racial categorization, and racial identity; life in the Spanish and Mexican borderlands prior to the American conquest; and the War between the United States and Mexico. (UC/CSU, AA GE, CSU GE, IGETC, CUL DIV)

ETHS 152 C Chicana-o History II 3 Units
Advisory: Eligibility for ENGL 100 C.
 Term hours: 54 lecture. This course is a survey of the Chicana/o experience from the Mexican-American War to the present. Topics covered include: the impact of the Mexican-American War on the lives of Mexicans in the American Southwest during the nineteenth century; immigration, labor struggles, and racial discrimination during the twentieth century; the struggles for civil rights and social equality; cultural affirmation and the construction of a "Chicana/o" identity; and the Chicana/o experience in contemporary America. (UC/CSU, AA GE, CSU GE, IGETC, CUL DIV)

ETHS 153 C Chicana-o Contemporary Issues 3 Units*Advisory: Eligibility for ENGL 100 C.*

Term hours: 54 lecture. This course focuses on the contemporary issues, characteristics, and significant contributions of the Chicana/o community. Emphasis is placed on contemporary sociological systems including, but not limited to, education, politics, social welfare, criminal justice, and the family. Some field study and research work may be required to provide relevant experiences. (UC/CSU, CSU GE, IGETC, CUL DIV)

ETHS 160 C Native American History 3 Units*Advisory: Eligibility for ENGL 100 C.*

Term hours: 54 lecture. This course is an historical examination of the native peoples of the Americas from their early beginnings to the present. Emphasis is placed on the relations between Native Americans and other peoples in the United States. A socio-cultural approach is utilized to develop a thorough understanding of the Native American experience. (UC/CSU, AA GE, CSU GE, IGETC, CUL DIV)

ETHS 170 C Introduction to Asian Pacific American Studies 3 Units*Advisory: Eligibility for ENGL 100 C.*

Term hours: 54 lecture. This course is an introduction to the field of Asian Pacific American Studies. An interdisciplinary approach will be employed to study the experiences of various Asian and Pacific Islander groups in the United States, utilizing the perspectives of race, nationality, class, gender, and sexuality. The course will cover historical and contemporary issues within Asian Pacific American communities, including immigration, anti-Asian violence, labor, unionization, and stereotypes. (UC/CSU, AA GE, CSU GE, IGETC, CUL DIV)

ETHS 171 C Asian Pacific American History 3 Units*Advisory: Eligibility for ENGL 100 C.*

Term hours: 54 lecture. This course is a survey of the Asian Pacific American experience in the United States from the mid-nineteenth century to the present. It addresses the historical forces that affected Asian Pacific American communities including: Chinese, Japanese, Filipino, Korean, Hawaiian, South Asian, and Southeast Asian. Topics covered include: Asian and Pacific Islander origins; immigration and settlement patterns; labor struggles and community formation; racism and U.S. exclusionary policies; the struggles for inclusion and civil rights; and the Asian Pacific American experience in contemporary America. (UC/CSU, AA GE, CSU GE, IGETC, CUL DIV)

ETHS 235 C American Social Justice Movements 3 Units

Term hours: 54 lecture. This course is an examination of the Post-World War II movements for social justice among people of color in the United States. It analyzes the socio-historical factors that led to the struggles against racial injustice while comparing their strategies and outcomes. Topics covered include the African-American Civil Rights and Black Power Movements; the Chicano Movement and other Latina/o activist struggles; the Asian-American Movement; Native American political activism; the roles of women and LGBT activists in social justice movements; and the attempts of these movements to eradicate racism, classism, sexism and homophobia in American society. (UC/CSU, AA GE, CSU GE, CUL DIV)

ETHS 298 C Ethnic Studies Seminar .5 to 12 Units*Prerequisite: May be required.**Corequisite: May be required.**Advisory: May be required.*

Term hours: 0-216 lecture and 0-432 laboratory depending on units attempted. This is a lecture/discussion course focusing on a particular limited problem or topic of interest to students. It is designed for students who wish to increase their knowledge of a particular topic concerning which no other regular class is offered. A paper or group activity may be requested. Consult the class schedule for the offerings in a particular semester. May be taken for credit 1-4 times. Pass/No Pass or Pass/No Pass/Letter Grade Option or Standard Letter Grade. Fees may be required-Payable at Registration. (UC Credit Limitation/CSU)

ETHS 299 C Ethnic Studies Independent Study 1 Unit*Prerequisite: Dean Approved Independent Study Learning Contract.*

Term hours: 16-18 lecture. Independent study is for students who wish to extend their knowledge of a particular area through individual research and study. It is thought that topics might develop out of a curiosity stimulated in a regular class. The student would then contact the supervising instructor to develop a contract for his/her particular interest so he/she could learn more regarding their special topic. May be taken for credit 4 times. (UC Credit Limitation/CSU)

**Flight Attendant —
See Aviation and Travel Careers (ATC)****Foreign Language**

For specific foreign language courses see Chinese, Japanese, French and Spanish.

FOREIGN LANGUAGE TRANSFER PROGRAM

Students should consult a counselor or www.assist.org for lower division major requirements for most California public universities. (See the Standard Definitions section of the catalog for a description of ASSIST.) Students transferring to an independent college/university should consult the catalog of the individual school and a counselor for lower division major requirements.

French

Division of Language Arts

Division Dean — Eldon Young

Counselors

Therese Mosqueda-Ponce
Daniel Pelletier

PROGRAM LEARNING OUTCOMES (PLOs)

The courses taught by this department contribute to the General Education and Basic Skills Program Learning Outcomes. Please refer to General Education and Basic Skills Program Learning Outcomes.

FRENCH TRANSFER PROGRAM

Students should consult a counselor or www.assist.org for lower division major requirements for most California public universities. (See the Standard Definitions section of the catalog for a description of ASSIST.) Students transferring to an independent college/university should consult the catalog of the individual school and a counselor for lower division major requirements.

French (FREN)

FREN 053 C Basic Spoken French 3 Units

Term hours: 54 lecture. This is an introductory course emphasizing oral practice, pronunciation, and vocabulary development. It is designed to develop a speaking knowledge of French for use in everyday conversational situations. It is an ideal preparation for college-level language classes for students with limited language skills. It is not open to native speakers of the language. Pass/No Pass/Letter Grade Option.

FREN 098 C French Seminar .5 to 12 Units

Prerequisite: May be required.
Corequisite: May be required.
Advisory: May be required.

Term hours: 0-216 lecture and/or 0-432 laboratory depending on units attempted. This seminar is for able students who wish to extend their knowledge of literature, language and culture through small group discussion. May be taken for credit 1-4 times. Pass/No Pass/Letter Grade Option. Fees may be required-Payable at Registration.

FREN 101 C Elementary French I 5 Units

Term hours: 90 lecture. The course emphasizes the acquisition of basic skills in pronunciation, listening, speaking, reading, and writing. Students will be introduced to the culture, history, and geography of France and other French-speaking countries through lectures, films, video, DVD, CD rom, Internet sites, and reading assignments. Pass/No Pass/Letter Grade Option. (UC/CSU, AA GE, CSU GE)

FREN 102 C Elementary French II 5 Units

Prerequisite: FREN 101 C with a minimum grade of "C" or better or one year of high school French with an average grade of "C" or better.
Term hours: 90 lecture. The course continues to emphasize the acquisition of basic skills in pronunciation, listening, speaking, reading, and writing. Students will increase their knowledge of the culture, history, and geography of France through lectures, slides, films, and reading and writing assignments. Pass/No Pass/Letter Grade Option. (UC/CSU, AA GE, CSU GE, IGETC)

FREN 200 C Conversational French 2 Units

Prerequisite: FREN 102 C.

Term hours: 36 lecture. This is a course in conversation with emphasis on the idiomatic use of the language through French films. Topics concern French life, culture, geography, and history. Students prepare for this class through the study of the textbook, magazines, newspapers, and other current material and encounters. This course is conducted in French. Pass/No Pass/Letter Grade Option. (CSU, CSU GE)

FREN 203 C Intermediate French III 4 Units

Prerequisite: FREN 102 C with a grade of "C" or two years of high school French with an average grade of "C".

Term hours: 72 lecture. The course emphasizes the acquisition of contextualized vocabulary and grammatical information to develop speaking, reading and writing skills. New cultural, historic and literary material is introduced through lectures, films, Internet sites, reading and writing assignments. This course is conducted in French. Pass/No Pass/Letter Grade Option. (UC/CSU, AA GE, CSU GE, IGETC)

FREN 204 C Intermediate French IV 4 Units

Prerequisite: FREN 203 C with grade of "C" or better or three years of high school French with an average grade of "C" or better.

Term hours: 72 lecture. The course emphasizes the mastery and application of grammatical rules. It requires more advanced reading of modern and classical French, as well as a continued emphasis on oral and written expression. It is designed to help the student acquire a working knowledge of the language and to form the basis for advanced work in literature and science. Continued readings and discussions of francophone life and culture are an essential factor. Pass/No Pass/Letter Grade Option. (UC/CSU, AA GE, CSU GE, IGETC)

FREN 298 C French Seminar .5 to 12 Units

Prerequisite: May be required.
Corequisite: May be required.
Advisory: May be required.

Term hours: 0-216 lecture and/or 0-432 laboratory depending on units attempted. This seminar is for able students who wish to extend their knowledge of literature, language and culture through small group discussion. Fees may be required-Payable at Registration. May be taken for credit 1-4 times. Pass/No Pass or Pass/No Pass/Letter Grade Option or Standard Letter Grade. (UC Credit Limitation/CSU)

FREN 299 C French Independent Study .5 to 2 Units

Prerequisite: Approved Independent Study Learning Contract.

Term hours: Two hours conference per week for maximum credit. This course is designed for able students who wish to increase their knowledge of the French language through individual study or research. Variable Unit Class. May be taken for credit 3 times. Pass/No Pass/Letter Grade Option. (UC Credit Limitation/CSU)

Geography

Division of Social Sciences

Division Dean — Lisa Gaetje, Interim

Faculty

Eric Bladh

Armando Mendoza

Counselors

Therese Mosqueda-Ponce

Daniel Pelletier

PROGRAM LEARNING OUTCOMES (PLOs)

The courses taught by this department contribute to the General Education and Basic Skills Program Learning Outcomes. Please refer to General Education and Basic Skills Program Learning Outcomes.

ASSOCIATE IN ARTS IN GEOGRAPHY FOR TRANSFER

DEGREE (AA-T)

Program Code: 1A32028

This curriculum is designed to provide an opportunity for the Geography major to achieve an Associate in Arts Degree in Geography for Transfer (AA-T in Geography) which completes the first and second year requirements for transfer to a four-year public California institution. This program is designed to prepare the student with a fundamental understanding and acquisition of knowledge in the Geography discipline. The curriculum includes courses in Human Geography, Physical Geography/Earth Science, and Earth Technologies, such as Geographic Information Systems, and Global Positioning Systems. While at least a baccalaureate degree is recommended preparation for those considering professional careers, completion of this curriculum will demonstrate commitment to the field and provide comprehensive preparation for further academic study through upper-division course work. This curriculum specifically prepares the prospective transfer student for upper division course work in Geography or a similar major at a California State University (CSU) campus. Students should consult a counselor, the Transfer Center and the catalog of the transfer college or university to plan a specific program of study to meet the college or university's requirements.

Note: Courses that fulfill major requirements for an Associate Degree for Transfer at Cypress College might not be the same as those required for completing the major at all transfer institutions offering a Baccalaureate Degree. The Student Transfer Achievement Reform Act (Senate Bill 1440, now codified in California Education Code sections 66746–66749) guarantees admission to a California State University (CSU) campus for any community college student who completes an “associate degree for transfer,” a newly established variation of the associate degrees traditionally offered at a California community college. The AA-T is intended for students who plan to complete a bachelor's degree in a similar major at a CSU campus. Students completing these degrees (AA-T) are guaranteed admission to the CSU system, but not to a particular campus or major. Students transferring to a CSU campus that does accept the AA-T will be required to complete no more than 60 units after transfer to earn a bachelor's degree (unless the major is designated “high-unit” major). This degree may not be the best option for students intending to transfer to a particular CSU campus or to a university or college that is not part of the CSU system. Students should consult with a counselor when planning to complete the degree

for more information on university admission and transfer requirements. The completion of this curriculum will demonstrate commitment to the Geography field and provide comprehensive preparation for upper-division work.

To earn an AA-T in Geography students must meet the following requirements: (1) a minimum of 19–20 semester units or 28.5–30 quarter units in the Geography major with a minimum grade of “C”; (2) California State University General Education Breadth requirements (CSU GE Breadth) or the Intersegmental General Education Transfer Curriculum (CSU IGETC); (3) completion of 60 semester or 90 quarter units of CSU transferable course work; and (4) have an overall GPA of 2.0.

| Required core courses (7 units) | | Units |
|--|------------------------------|--------------|
| GEOG 102 C | Physical Geography | 3 |
| GEOG 102LC | Physical Geography-Lab | 1 |
| GEOG 160 C | Cultural Geography | 3 |
| List A (Select 6–7 units from the following): | | Units |
| GEOG 202 C is optional if offered. | | |
| GEOG 100 C | World Geography | 3 |
| | or | |
| GEOG 100HC | Honors World Geography | (3) |
| GEOG 130 C | California Geography | 3 |
| GEOG 230 C | Introduction to GIS | 3 |
| GEOG 140 C | Weather and Climate | 3 |
| GEOG 202 C | Field Geography — Physical | 1 |
| List B (Select 6 units from the following or any courses not selected from List A): | | Units |
| ANTH 102 C | Cultural Anthropology | 3 |
| | or | |
| ANTH 102HC | Honors Cultural Anthropology | (3) |
| POSC 230 C | International Relations | 3 |
| Total Units Required | | 19–20 |

ASSOCIATE IN ARTS DEGREE GEOGRAPHY

Program Code: 1A19681

The Associate in Arts Degree in Geography is designed to provide students with a comprehensive introduction to the three distinct areas of geographic studies (Earth Science/Environmental Studies/Physical; Earth Technologies; and Human Studies) in order to give them the background knowledge needed by undergraduate geography majors for university transfer and course work, while emphasizing the practical applications of geographic skills and knowledge in a diversity of careers and the utility of geographic perspectives as a life-long learning tool for interpreting our world's complex systems and world events.

To earn an Associate Degree, students must complete: (1) all major course requirements with a minimum grade of “C”; (2) California State University General Education Breadth requirements (CSU GE Breadth) or IGETC general education plan; (3) any elective courses to complete a minimum of 60 units; (4) complete all graduation requirements; and (5) have an overall GPA of 2.0. At least 50% of all major course work must be completed at Cypress College. Students pursuing more than one specified departmental major may double count a maximum of 7 units to fulfill major requirements. Courses that fulfill major requirements for an Associate Degree at Cypress College might not be the same as those required for completing the major at a transfer institution offering a Baccalaureate Degree. For information on specific university requirements, please consult with your counselor, or visit the Transfer Center.

Required courses (13 Units):

| Course # | Title | Units |
|-------------|--------------------------|-------|
| GEOG 100 C | World Geography | 3 |
| | or | |
| GEOG 100HC | Honors World Geography | (3) |
| GEOG 102 C | Physical Geography | 3 |
| GEOG 102LC | Physical Geography - Lab | 1 |
| *GEOG 160 C | Cultural Geography | 3 |
| GEOG 130 C | California Geography | 3 |

Elective courses: (6 Units)

GEOG 202 C is optional if offered:

| Course # | Title | Units |
|------------|----------------------------|-------|
| GEOG 140 C | Weather and Climate | 3 |
| GEOG 260 C | Economic Geography | 3 |
| GEOG 202 C | Field Geography — Physical | 1 |
| ANTH 104 C | Comparative Cultures | 3 |
| POSC 230 C | International Relations | 3 |
| HIST 112 C | World Civilizations I | 3 |

Total Units Required 19

*A score of 3 or higher on the Advanced Placement (AP) Geography (Human) exam meets this requirement upon petition through Admissions and Records. See a counselor for more information.

GEOGRAPHIC INFORMATION SYSTEMS CERTIFICATE Program Code: 1C07825

Provide endorsed entry-level skills for the rapidly growing GIS field. Our certificate is the first general purpose GIS certificate approved by the California State Chancellor's office.

To earn a certificate, students must complete the required courses as listed with a minimum grade of "C." At least 50% of all course work must be completed at Cypress College. College certificate is inclusive of tiers one through four in the U.S. Department of Labor's Geospatial Industry Competency Model of June 1, 2010.

Geographic Information Systems (12 units) required:

| Course # | Title | Units |
|------------|----------------------------|-------|
| GEOG 230 C | Introduction to GIS | 3 |
| GEOG 231 C | GIS: Spatial Analysis | 3 |
| GEOG 232 C | GIS: Analysis and Modeling | 3 |
| GEOG 233 C | GIS: Advanced/Internship | 3 |

Spatial Courses (3 units) from the following:

| | | |
|-------------|--------------------|---|
| GEOG 100 C | World Geography | 3 |
| *GEOG 160 C | Cultural Geography | 3 |

Spatially Related Courses (3–5 units) from the following:

| | | |
|-------------|-------------------------------|---|
| ANTH 102 C | Cultural Anthropology | 3 |
| ANTH 103 C | Introduction to Archaeology | 3 |
| BIOL 103 C | Environmental Science | 3 |
| BIOL 122 C | Marine Biology | 4 |
| ECON 260 C | Economic Geography | 3 |
| GEOG 100 C | World Geography | 3 |
| GEOG 102 C | Physical Geography | 3 |
| GEOG 130 C | California Geography | 3 |
| GEOG 140 C | Weather and Climate | 3 |
| *GEOG 160 C | Cultural Geography | 3 |
| GEOG 202 C | Field Geography — Physical | 1 |
| GEOG 234 C | Current Topics in GIS | 3 |
| GEOG 260 C | Economic Geography | 3 |
| GEOL 100 C | Physical Geology | 3 |
| GEOL 120 C | Geology of California | 3 |
| GEOL 130 C | Introduction to Oceanography | 3 |
| GEOL 190 C | Environmental Geology | 3 |
| HS 147 C | Survey of Disease | 3 |
| ATC 174 C | Destinations: Americas/Europe | 3 |
| ATC 175 C | Destinations: Africa/Pacific | 3 |
| MKT 222 C | Principles of Marketing | 3 |
| MKT 224 C | International Marketing | 3 |
| ASTR 116 C | Introduction to Astronomy | 3 |

Spatial Course with Lab (4 units) from the following:

| | | |
|------------|-----------------------------|---|
| GEOG 102 C | Physical Geography | 3 |
| GEOG 102LC | Physical Geography — Lab | 1 |
| GEOL 100 C | Physical Geology | 3 |
| GEOL 101 C | Physical Geology Laboratory | 1 |
| GEOG 202 C | Field Geography — Physical | 1 |

Computer Programming Skills: (3 units) from the following:

| | | |
|-----------|--|---|
| CIS 211 C | Introduction to Programming | 3 |
| CIS 229 C | Introduction to XML Programming | 3 |
| CIS 236 C | Introduction to Oracle: SQL and PL/SQL | 3 |
| CIS 247 C | Python Programming | 3 |

Total Units Required 25–27

*A score of 3 or higher on the Advanced Placement (AP) Geography (Human) exam meets this requirement upon petition through Admissions and Records. See a counselor for more information.

GEOGRAPHIC INFORMATION SYSTEMS/MARKETING CERTIFICATE Program Code: 1C12953

This certificate program provides students with the skills to use Geographic Information Systems (GIS) computerized mapping techniques in the field of marketing. Combining the latest computer graphics and marketing research methods, students will learn to create maps to locate customers, evaluate business sites, plan distribution networks and sales territories, and find new business opportunities.

To earn a certificate, students must complete the required courses as listed with a minimum grade of "C." At least 50% of all course work must be completed at Cypress College.

Required courses are listed in suggested sequence:

| Course # | Title | Units |
|-----------------------------|-------------------------|-----------|
| MKT 222 C | Principles of Marketing | 3 |
| MKT 210 C | Consumer Behavior | 3 |
| MKT 224 C | International Marketing | 3 |
| GEOG 230 C | Introduction to GIS | 3 |
| GEOG 231 C | GIS: Spatial Analysis | 3 |
| Total Units Required | | 15 |

GEOGRAPHY TRANSFER PROGRAM

Students should consult a counselor or www.assist.org for lower division major requirements for most California public universities. (See the Standard Definitions section of the catalog for a description of ASSIST.) Students transferring to an independent college/university should consult the catalog of the individual school and a counselor for lower division major requirements.

Geography (GEOG)

GEOG 100 C World Geography 3 Units

Term hours: 54 lecture. An introduction to today's physical and political regions emphasizing location, population, political status, land use problems and potentialities and providing opportunities for worldwide research. Duplicate credit not granted for GEOG 100HC. (UC Credit Limitation/CSU, AA GE, CSU GE, IGETC, C-ID: GEOG 125)

GEOG 100HC Honors World Geography 3 Units

Term hours: 54 lecture. An enhanced introduction to today's physical and political regions emphasizing location, population, political and economic status, differences and similarities, problems and potentialities and providing opportunities for worldwide research. Duplicate credit not granted for GEOG 100 C. (UC Credit Limitation/CSU, AA GE, CSU GE, IGETC, C-ID: GEOG 125)

GEOG 102 C Physical Geography 3 Units

Term hours: 54 lecture. This course is an investigation and interpretation of the sun-earth relationship, science maps, weather and climate, the hydrosphere, cycles and patterns in the biosphere, flora and fauna, soils, rocks, and minerals, weathering, mass wasting, erosion, and origin and types of landforms that provide insight into the nature of the physical environment. (UC/CSU, AA GE, CSU GE, IGETC, C-ID: GEOG 110)

GEOG 102LC Physical Geography - Lab 1 Unit

Prerequisite: Completion of or concurrent enrollment in GEOG 102 C.
Term hours: 36 laboratory and 18 laboratory/quiz/problem solving. This course investigates and interprets in a laboratory environment the sun-earth relationships, science of maps, weather and climate, climatic types and locations, natural vegetation, soils and minerals, ocean environment, and the origin and types of landforms that provide insight into the nature of the physical environment. (UC/CSU, AA GE, CSU GE, IGETC, C-ID: GEOG 111)

GEOG 120 C Introduction to Spatial Reasoning 3 Units

Term hours: 54 lecture. Introduction to the fundamental concepts of Geographic Information Science and Technology (GIS&T) including Geographic Information Systems (GIS), Global Positioning Systems (GPS), cartography, remote sensing, and spatial analysis. Exploration of how geospatial technologies are used in addressing human and environmental issues. (UC/CSU)

GEOG 130 C California Geography 3 Units

Term hours: 54 lecture. This course investigates and interprets the physical, cultural and economic bases and regions of the state of California. Particular emphasis is placed upon the natural foundations of the landscape with the exploration of the unique nature and special characteristics of the people utilizing that landscape. (UC/CSU, CSU GE, IGETC, C-ID: GEOG 140)

GEOG 140 C Weather and Climate 3 Units

Term hours: 54 lecture. This course is an investigation and interpretation of the earth's atmosphere and the science behind local and global surface weather phenomena. Particular emphasis is placed upon the interrelationships between weather and climate and upon meteorological forecasting techniques. (UC/CSU, CSU GE, IGETC, C-ID: GEOG 130)

GEOG 160 C Cultural Geography 3 Units

Term hours: 54 lecture. This course investigates and interprets the interrelationship of human activities with cultural background, physical environment and the diffusion of ideas. Emphasis is placed on where and why people locate, the distribution of different cultural characteristics on the earth's surface, how people earn a living in various parts of the world, how people organize their lives and how their problems may result from the use of the earth's resources. (UC/CSU, AA GE, CSU GE, IGETC, C-ID: GEOG 120)

GEOG 202 C Field Geography - Physical 1 Unit

Prerequisite: Completion of or concurrent enrollment in GEOG 102 C.
Term hours: 18 lecture in the field (location TBA). Each separate offering of this course will occur in a unique location, studying unique circumstances and conditions in the field. Each course will employ its own combination of technical equipment, scientific instruments, and geotechniques. All courses will study the basic conceptual materials, with modifications associated with the location and the specific conditions encountered at each season. Field trip cost not to exceed \$40.00. (UC/CSU, C-ID: GEOG 160)

GEOG 230 C Introduction to GIS 3 Units

Term hours: 36 lecture and 54 laboratory. This course will introduce the student to Geographic Information Systems technology and software. Students will be taught how to retrieve and apply data in their chosen business and/or academic area of interest. \$4.00 Materials Fee-Payable at Registration. (CSU, C-ID: GEOG 155)

GEOG 231 C GIS: Spatial Analysis 3 Units

Prerequisite: GEOG 230 C.
Term hours: 36 lecture and 54 laboratory. Geographic Information Systems (such as ArcGIS) is introduced as a tool to analyze and solve problems, and to discover opportunities for business and academic applications. Students will apply this software in student selected projects. A semester project will be required of each student. \$4.00 Materials Fee-Payable at Registration. (CSU)

GEOG 232 C GIS: Analysis and Modeling 3 Units

Prerequisite: GEOG 231 C.
Term hours: 36 lecture and 54 laboratory. This course introduces students to advanced topics, techniques, and analysis in Geographic Information Systems (GIS). Students will retrieve and apply data in their chosen business or academic area of interest. \$4.00 Materials Fee-Payable at Registration. (CSU)

GEOG 233 C GIS: Advanced/Internship 3 Units

Prerequisite: GEOG 232 C.
Term hours: 9 lecture and 125 hours fieldwork. Internships and fieldwork comprise a significant portion of the students' work in this Geographic Information Systems (GIS) course. Students are required to participate in 125 hours of supervised field study per semester (7 hours per week) and one hour lecture per week to discuss problem areas related to fieldwork. \$4.00 Material Fee-Payable at Registration. (CSU)

GEOG 234 C Current Topics in GIS 3 Units

Term hours: 36 lecture and 54 laboratory. This is an advanced lecture/discussion project type course designed to cover current issues and advances in Geographic Information Systems. It is designed for students who have experience in GIS applications and wish to update their knowledge and working skills. A final semester project, utilizing GIS for a project chosen by the student will be required. May be taken for credit 3 times. \$4.00 Material Fee-Payable at Registration. (CSU)

GEOG 260 C Economic Geography 3 Units

Same as ECON 260 C
 Term hours: 54 lecture. This course is an investigation and interpretation of the world's economic organization, its natural resources, raw materials, crops and crop production, manufacturing and service industries, new trends in producing and the changing centers of production and consumption. Duplicate credit not granted for ECON 260 C. (UC/CSU, CSU GE, IGETC)

GEOG 298 C Geography Seminar .5 to 12 Units

Prerequisite: May be required.
Corequisite: May be required.
Advisory: May be required.

Term hours: 0-216 lecture and/or 0-756 laboratory. This is a lecture/discussion type course developed on a particular limited problem or topic of interest to students. It is designed for able students who wish to increase their knowledge of a particular topic concerning which no other regular class is offered. A paper or group activity may be requested. Credit may range from 1/2 unit to 12 units. Consult class schedule for the offerings in a particular semester. Fees may be required-Payable at Registration. May be taken for credit 1-4 times. Pass/No Pass or Pass/No Pass/Letter Grade Option or Standard Letter Grade. (UC Credit Limitation/CSU)

GEOG 299 C Geography Independent Study 1 Unit

Prerequisite: Approved Independent Study Learning Contract.
 Term hours: 18 lecture. Independent study is for able students who wish to extend their knowledge of a particular area through individual research and study. It is thought the topics might develop out of a curiosity stimulated in a regular class. The student would then contact the supervising instructor to develop a contract for his/her particular interest so that they could learn more regarding their specific topic. May be taken for credit 3 times. (UC Credit Limitation/CSU)

Geology

Division of Science/Engineering/Mathematics

Division Dean — Richard Fee

Faculty

Victoria Castle
 Kirk Domke

Counselor

Deidre Porter

PROGRAM LEARNING OUTCOMES (PLOs)

The courses taught by this department contribute to the General Education and Basic Skills Program Learning Outcomes. Please refer to General Education and Basic Skills Program Learning Outcomes.

GEOLOGY TRANSFER PROGRAMS

Students should consult a counselor or www.assist.org for lower division major requirements for most California public universities. (See the Standard Definitions section of the catalog for a description of ASSIST.) Students transferring to an independent college/university should consult the catalog of the individual school and a counselor for lower division major requirements.

ASSOCIATE IN SCIENCE IN GEOLOGY FOR TRANSFER DEGREE (AS-T)

Program Code: 1S31935

This curriculum is designed to provide an opportunity for the Geology major to achieve an Associate in Science Degree in Geology for Transfer (AS-T in Geology) which completes the first and second year requirements for transfer to a four-year public California institution. Students with a degree in geology may pursue careers in education, consulting, research or work in industry as an entry geologist or geotechnician in fields such as engineering geology, environmental geology, petroleum and mining geology, hydrogeology, seismology, paleontology, geophysics, marine geology and volcanology. While at least a baccalaureate degree is recommended preparation for those considering professional careers, completion of this curriculum will demonstrate commitment to the field and provide comprehensive preparation for further academic study through upper-division course work. This curriculum specifically prepares the prospective transfer student for upper division course work in Geology or a similar major at a California State University (CSU) campus. Students should consult a counselor, the Transfer Center and the catalog of the transfer college or university to plan a specific program of study to meet the college or university's requirements.

Note: Courses that fulfill major requirements for an Associate Degree for Transfer at Cypress College might not be the same as those required for completing the major at all transfer institutions offering a Baccalaureate Degree. The Student Transfer Achievement Reform Act (Senate Bill 1440, now codified in California Education Code sections 66746–66749) guarantees admission to a California State University (CSU) campus for any community college student who completes an “associate degree for transfer,” a newly established variation of the associate degrees traditionally offered at a California community college. The AS-T is intended for students who plan to complete a bachelor's degree in a similar major at a CSU campus. Students completing these degrees (AS-T) are guaranteed admission to the CSU system, but not to a particular campus or major. Students transferring to a CSU campus that does accept the AS-T will be required to complete no more than 60 units after transfer to earn a bachelor's degree (unless the major is designated “high-unit” major). This degree may not be the best option for students intending to transfer to a particular CSU campus or to a university or college that is not part of the CSU system. Students should consult with a counselor when planning to complete the degree for more information on university admission and transfer requirements.

To earn an AS-T in Geology students must complete the following requirements: (1) a minimum of 26 semester units or 39 quarter units in the Geology major with a minimum grade of “C”; (2) California State University General Education Breadth requirements (CSU GE Breadth) or the Intersegmental General Education Transfer Curriculum (CSU IGETC); (3) completion of 60 semester or 90 quarter units of CSU transferable course work; and (4) have an overall GPA of 2.0.

| Core Courses (26 units) | | Units |
|-------------------------|-----------------------------|-------|
| GEOL 100 C | Physical Geology | 3 |
| | or | |
| GEOL 100HC | Honors Physical Geology | (3) |
| GEOL 101 C | Physical Geology Laboratory | 1 |
| GEOL 103 C | Historical Geology | 4 |
| CHEM 111AC | General Chemistry I | 5 |
| CHEM 111BC | General Chemistry II | 5 |
| MATH 150AC | Calculus I | 4 |
| MATH 150BC | Calculus II | 4 |

| Additional Recommended Course Work (not required) | | Units |
|---|------------------------|-----------|
| PHYS 221 C | General Physics I | 4 |
| PHYS 222 C | General Physics II | 4 |
| BIOL 101 C | General Biology | 5 |
| | or | |
| BIOL 101HC | Honors General Biology | (5) |
| Total Units Required | | 26 |

Geology (GEOL)

GEOL 100 C Physical Geology **3 Units**

Term hours: 54 lecture. This introductory course is a survey of the composition, structure, processes and forces that operate underneath and upon Earth's surface. Topics include plate tectonics, rocks/minerals, earthquakes, volcanoes, landslides, resources, and environmental concerns. Field trips may be required not to exceed \$25. Duplicate credit not granted for GEOL 100HC. (UC/CSU, AA GE, CSU GE, IGETC, C-ID: GEOL 100)

GEOL 100HC Honors Physical Geology **3 Units**

Term hours: 54 lecture. This course is an enhanced introduction to the concepts and theories of geology. Includes a survey of the composition, structure, processes and forces that operate underneath and upon Earth's surface. Topics include plate tectonics, rocks/minerals, earthquakes, volcanoes, landslides, resources, and environmental concerns. Field trips may be required not to exceed \$25. Duplicate credit not granted for GEOL 100 C. (UC/CSU, AA GE, CSU GE, IGETC, C-ID: GEOL 100)

GEOL 101 C Physical Geology Laboratory **1 Unit**

Prerequisite: Completion of or concurrent enrollment in GEOL 100 C.
Term hours: 54 laboratory. This course includes the identification of minerals and rocks; understanding of topographic maps, aerial photographs and other imagery from remote sensing; interpretation of rocks, structures, and geologic processes as revealed on maps, air photos, and satellite imagery and their relationship to plate tectonics. Not open to students with credit in GEOL 102 C. (UC/CSU, AA GE, CSU GE, IGETC, C-ID: GEOL 100L)

GEOL 103 C Historical Geology **4 Units**

Term hours: 54 lecture and 54 laboratory. This course is an introduction to the scientific method of exploring Earth's history and the life it supports. Subjects include geologic dating, plate tectonics, stratigraphy, fossils, biological evolution and Earth's origin and processes. Cost of field trips will not exceed \$20.00. (UC/CSU, AA GE, CSU GE, IGETC, C-ID: GEOL 111)

GEOL 105 C Earth Science for Teachers **4 Units**

Term hours: 54 lecture and 54 laboratory. This class is designed for the prospective school teacher. This multidisciplinary course will explore the fields of geology, oceanography, meteorology, and astronomy. Topics include solar system, mineral/rock formation, star/galaxy, atmosphere, volcanoes, and earthquakes. (CSU, AA GE, CSU GE)

GEOL 115 C Physical Geology Field Lab **1 Unit**

Prerequisite: Earth science class as approved by instructor.
Corequisite: GEOL 100 C or GEOL 100HC.
Term hours: 54 laboratory. This course includes field and laboratory study of mineral, rock, and fossil identification; structural and geomorphic features; geologic history; and geologic hazards of selected regions in California, Arizona and Utah. Field trip fees range from \$25-\$155 depending on trip location. (UC Credit Limitation/CSU, AA GE, CSU GE, IGETC)

GEOL 120 C Geology of California **3 Units**

Term hours: 54 lecture. This course is designed to acquaint the student with the physical and historical geology of the natural provinces of California. The mineral deposits, stratigraphic and rock units, tectonic structures, fossils and geomorphology within each province will be examined. (UC/CSU, AA GE, CSU GE, IGETC)

GEOL 125 C Natural Disasters **3 Units**

Term hours: 54 lecture. This course is an introduction to the science of natural disasters. Topics include earthquakes, volcanoes, landslides, hurricanes, tornadoes, floods, climate change and mass extinctions. Case studies, monitoring methods and disaster planning will be addressed. (UC/CSU, AA GE, CSU GE, IGETC)

GEOL 130 C Introduction to Oceanography **3 Units**

Term hours: 54 lecture. This course is a survey of the composition and structure of the earth's ocean showing the interrelationship between atmosphere, hydrosphere, lithosphere, and biosphere. The effects of modern technology, ocean resources, and marine pollution will be explored. Field trips may be required with a fee not to exceed \$25. (UC/CSU, AA GE, CSU GE, IGETC)

GEOL 131 C Introduction to Oceanography Lab **1 Unit**

Prerequisite: Completion of, or concurrent enrollment in, GEOL 130 C.
Term hours: 54 laboratory. This course includes the identification of earth materials; understanding of bathymetric charts; basic navigation; and methods of oceanographic research. Field trips may be required at no additional cost. (UC/CSU, AA GE, CSU GE, IGETC)

GEOL 190 C Environmental Geology **3 Units**

Term hours: 54 lecture. This course is designed for the non-science major and will integrate the significant principles and concepts of the solid earth, atmosphere, space and hydrospace and relate them to the environment, with special emphasis on resources, wastes and hazards. The perspective will focus on ways in which earth processes generate the varieties of resources useful in humans in the form of metal, non-metals, energy, water, ocean and soil. Hazards such as liquid, solid and radioactive wastes and their effects on environmental deterioration will be studied. Natural hazards such as floods, faults, landslides and earthquakes will be examined. The course is not open to students who have completed GEOL 100 C or GEOL 102 C. (UC Credit Limitation/CSU, AA GE, CSU GE, IGETC)

GEOL 298 C Geology Seminar **.5 to 4 Units**

Prerequisite: May be required.
Corequisite: May be required.
Advisory: May be required.
Term hours: 9-72 lecture and/or 27-216 laboratory depending on units attempted. The seminars are designed to enhance and intensify knowledge in a variety of geologic topics. They may include lectures, discussions, and field excursions at the discretion of the instructor. Specific topics for seminars will be listed in the class schedule for a particular semester. Pass/No Pass/Letter Grade Option or Standard Letter Grade. Fees may be required – Payable at Registration (UC Credit Limitation/CSU)

Graphic Arts — See Media Art Design (MAD)

Health Information Technology

Division of Health Science

Division Dean — Rebecca Gomez, Interim

Faculty

Rebecca Gomez
Jennie Larez

Counselors

Kelly Carter
Denise Vo
Doreen Villaseñor

PROGRAM LEARNING OUTCOMES (PLOs)

Health Information Technology

A student who completes the Health Information Technology program will be able to:

- Gain the knowledge and skills needed to perform entry level functions in health information management technology.
- Attain the knowledge and skills needed to successfully pass entry level HIM certification examinations, especially the Registered Health Information Technician examination.
- Obtain HIM-related positions or be enrolled in an advanced degree program within 6 months of completion of the program.

ASSOCIATE IN SCIENCE DEGREE

HEALTH INFORMATION TECHNOLOGY

Program Code: 1S03788

Health information professionals care for patients by caring for their medical data. They ensure that all of a patient's health information is complete, accurate, and protected, yet readily available for healthcare providers when needed. There are three professional and academic areas of health information that you can learn about below: Health Information Management, Health Information Technology, and Health Informatics. Health information management (HIM) is the practice of acquiring, analyzing, and protecting digital and traditional medical information vital to providing quality patient care. Health information technology (Health IT) refers to the framework used to manage health information, and the exchange of health information in a digital format. Health Informatics (HI) is a science that defines how health information is technically captured, transmitted and utilized. Health information management professionals work in a variety of different settings and job titles. They often serve in bridge roles, connecting clinical, operational, and administrative functions. These professionals affect the quality of patient information and patient care at every touchpoint in the healthcare delivery cycle. Having skilled HIM professionals on staff ensures an organization has the right information available when and where it is needed while maintaining the highest standards of data integrity, confidentiality, and security. They are vital to the daily operations management of health information and electronic health records. Because health information coding is at the heart of both health care reimbursement and clinical analysis, this extremely important aspect of health information management requires a highly trained and accurate professional who can assign numerical codes to diagnoses, symptoms, and procedures using the current diagnostic coding and procedure classification systems which include ICD 9-CM, ICD-10-CM and ICD 10-PCS and Current Procedural Terminology (CPT). Most third

party payers, including the federal government and private insurance companies, require submission of diagnoses and procedure codes as part of the hospital and/or physician billing process. Diagnoses and procedures codes are needed for comparing and tracking diseases, clinical research, statistical reporting, market data and planning. Professionals who work in health IT (information technology) are focused on the technical side of managing health information, working with software and hardware used to manage and store patient data. Health IT professionals are usually from Information Technology backgrounds, and provide support for electronic health records and other systems HIM professionals use to secure health information. A career in HIM/Health IT/HI is right for you if you:

- See yourself in a career that offers diverse opportunities.
- Would like to work in health care, but not directly with patients.
- Have an aptitude for science, but also like management, law, and computers.
- Enjoy working with professionals: physicians, nurses, lawyers, administrators and executives.
- Want a career where you can choose to work on your own, with others, or some of both.

HIM programs incorporate the disciplines of medicine, management, finance, information technology, and law into one curriculum. Because of this unique mixture, HIM graduates can choose from a variety of work settings across an array of healthcare environments. The program is accredited by the Commission on Accreditation of Health Informatics and Information Management Education. Graduates of the Program are, therefore, eligible to take the national examination leading to certification as a Registered Health Information Technician (RHIT).

MINIMUM STANDARDS FOR APPLICANTS:

1. Eligibility for admission to Cypress College.
2. Completion of ENGL 100 C with a grade of "C" or better or transcript showing course in progress.
3. Completion of CIS 111 C Computer Information Systems with a grade of "C" or better or transcript showing course in progress.
4. Completion of HS 145 C Survey of Medical Terminology with a grade of "C" or better or transcript showing course in progress.
5. Eligibility for MATH 120 C Introduction to Probability and Statistics or transcript showing appropriate Math course in progress.

APPLICATION PROCEDURES:

1. In addition to the Cypress College application form, a separate application is required for admission into the Health Information Technology Program. Applications must be completed online. Please see the Health Science Application link on the Health Information Technology home page.
2. Qualified students are selected each spring and fall semester. Applicants may exceed the available seat space. Prioritization of qualified applicants will determine acceptance.
3. Applicants are responsible for submitting all documents (records, forms and transcripts) indicating minimum standards and prerequisites have been met to the Health Science Counseling Office.

SELECTION PROCEDURES:

Students will be selected using a point system based on the number of general education/graduation courses completed at the time of application. Criteria are subject to change. For information see a Health Science Counselor.

SPECIAL REQUIREMENTS AND EXPENSES INCURRED BY HEALTH INFORMATION TECHNOLOGY STUDENTS BEFORE ASSIGNMENT TO CLINICAL FACILITIES/AGENCIES

This information is intended to assist those who are planning enrollment in the HIT program prepare for educational expenses. In addition to enrollment fees PAYABLE AT REGISTRATION, the HIT student incurs additional expenses. Clinical practice sites are located throughout Riverside, Orange and Los Angeles counties. Clinical assignments are scheduled during the day. The student will need reliable personal transportation in order to travel to assigned agencies at least one day a week in each directed practice course. All enrolled students must meet the same health and safety standards required of agency employees in the contracted clinical facilities. For this reason each student enrolled in the HIT program must complete specific requirements at his/her own expense prior to agency assignment. Information regarding the specific requirements in place at the time of initial enrollment into HIT Program is provided at a mandatory orientation scheduled for applicants selected each semester.

1. Physical examination with health clearance indicating good physical and mental health status with no physical limitations which would impede the ability to operate a computer keyboard; read a visual display terminal; and sit for a long period of time.
2. Proof of current immunizations or immunity by titer.
3. Testing for communicable diseases including, but not limited to, the following: tuberculosis, rubella, rubeola, varicella, hepatitis.
4. Professional liability insurance.
5. Clean background checks.

REQUIRED CURRICULUM:

Transferability of health information course work is determined by the individual receiving college. To earn an Associate Degree, students must complete:

- (1) all major course requirements with a minimum grade of "C";
- (2) 25 units of General Education Graduation Requirements;
- (3) the cultural diversity and reading requirements;
- (4) any elective courses to complete a minimum of 60 units; and,
- (5) have a minimum GPA of 2.0.

At least 50% of all major course work must be completed at Cypress College. To earn a certificate, students must (1) document a minimum of an Associate Degree; and (2) complete all major course work with a minimum grade of "C."

| Prerequisites | | Units |
|----------------------------|--|--------------|
| CIS 111 C | Computer Information Systems | 3 |
| HS 145 C | Survey of Medical Terminology | 3 |
| ENGL 100 C | College Writing | 4 |
| Eligibility for MATH 120 C | | |
| SEMESTER 1 | | Units |
| HI 100 C | Trends in Health Care Delivery | 3 |
| HI 101 C | Health Information Management | 3 |
| BIOL 210 C | Anatomy and Physiology | 5 |
| MATH 120 C | Introduction to Probability and Statistics | 4 |
| SEMESTER 2 | | Units |
| HI 102 C | Legal Aspects of Health Care | 3 |
| HI 103 C | Healthcare Data Analysis | 3 |
| HI 114 C | Beginning ICD 10-CM Coding | 3 |
| HS 147 C | Survey of Disease | 3 |

| SEMESTER 3 | | Units |
|-----------------------------|--|--------------|
| HI 203 C | Medical Quality Management | 3 |
| HI 214 C | CPT/Ambulatory Care Coding | 3 |
| HI 225 C | Information Technology | 3 |
| HI 230 C*** | Directed Practice I | 3 |
| SEMESTER 4 | | Units |
| CIS 236 C | Introduction to Oracle: SQL and PL/SQL | 3 |
| HI 224 C | Advanced ICD-10 Coding | 3 |
| HI 240 C*** | Directed Practice II | 4 |
| HI 245 C | Coding Skills Lab | 2 |
| Total Units Required | | 61 |

***This course is a non-paid laboratory experience. Students are assigned to a health care agency.

Health Information Technology (HI)

HI 080 C Selected Topics .5 to 8 Units

Term hours: Variable hours lecture and variable hours laboratory per week. This course is designed to meet the health information technology student's need for current topics and issues, updated information in health care review of specialized subject matter and/or preparation for health information related certification exams. Content will emphasize clinical application of theoretical principles in the discipline. Computer software, videotapes, resource materials, instructor assessment of individual student knowledge and skills will be utilized. Variable Unit Class. May be taken for credit 4 times. Pass/No Pass/Letter Grade Option.

HI 100 C Trends in Health Care Delivery 3 Units

Term hours: 54 lecture. This course investigates how and where health care is delivered in the United States and examines different health care practitioners and professional healthcare associations, the role of federal, state and local governments in health care, and the impact of managed care organizations. How consumers pay for health care as well as how health care providers receive reimbursement for services are discussed. The principles of customer focused health care are discussed. Current issues affecting the delivery of health care are emphasized. The course is recommended for students interested in health care or preparing for careers in health care. (CSU)

HI 101 C Health Information Management 3 Units

Prerequisite: CIS 111 C with a minimum grade of "C" and acceptance in the Health Information Technology Program.

Term hours: 36 lecture and 54 laboratory. This course investigates the content, use and structure of health care data and data sets and how these components relate to primary and secondary health information systems across the healthcare delivery system. Emphasis is on medical record documentation requirements pursuant to federal/state regulations and voluntary accrediting body standards. Discussions will focus on regulatory issues, documentation requirements, quality and utilization management, risk management and the role of the HIM professional in healthcare delivery. Laboratory activities will include use of electronic health records; assembly and analysis of medical records; and reading and interpreting medical records and researching healthcare documentation requirements. \$4.00 Material Fee-Payable at Registration. (CSU)

HI 102 C Legal Aspects of Health Care 3 Units

Prerequisites: Acceptance in the Health Information Technology Program.

Term hours: 54 lecture. The focus of this course is on the legal and ethical issues affecting health care industry, health care providers, and health information managers. State laws, federal regulations, and case precedents form the basis for class discussion. Topics include tort law, confidentiality, release of protected health information (PHI), informed consent, corporate compliance, patient rights, negligence and medical malpractice, contract and labor law, and medical staff organization. Special emphasis is placed on the HIPAA Privacy and Security rules and measures to safeguard against disclosure of PHI. (CSU)

HI 103 C Healthcare Data Analysis 3 Units

Prerequisite: HI 101 C and MATH 120 C with minimum grades of "C".

Term hours: 36 lecture and 54 laboratory. This course focuses on the collection, presentation and analysis of healthcare data that forms the basis for administrative and clinical decision-making. The use of data in clinical research, vital statistics and population health will be discussed. Laboratory activities will focus on development of skills in calculating and displaying data electronically and interpreting healthcare data. The role of the certified health data analyst in acquiring, managing, analyzing, interpreting and transforming data into accurate, consistent, and timely information will be stressed. Data reliability and validity are emphasized. (CSU)

HI 105 C Directed Practice I 4 Units

Prerequisite: HI 101 C and CIS 111 C and enrollment in the Health Information Technology Program.

Term hours: 36 lecture and 108 laboratory. This course is an investigation of the components of the content, use, and structure of health care data and data sets in the following alternative health care settings: long term care, home health, hospice, ambulatory care, behavioral health and rehab services. Emphasis is on analyzing the content of the health record and documentation requirements pursuant to federal/state regulations and voluntary accrediting body standards. Discussions will focus on the opportunities for health information management professionals in these different settings. Directed practice activities focus on the abstracting of data, analysis of findings, and preparation of reports in alternative health care settings. Students are assigned to an affiliated health related agency for supervised directed practice. Students shall have the status of learner and shall not be considered agency employees, nor shall they replace agency staff. Directed practice is conducted as a nonpaid, laboratory experience. (CSU)

HI 110 C Medical Insurance Billing 3 Units

Prerequisite: HS 145 C or equivalent.

Term hours: 54 lecture. This course focuses on the principles and mechanics of ambulatory care and medical office billing and will cover the entire billing process from the initial verification of insurance benefits, to the submission of the claim form, and to final collections process. It provides exposure to the many types of private and governmental insurance: Medicare, Medicaid, Blue Cross, health maintenance organizations, workers compensation, etc. CPT and ICD-9-CM coding principles related to claims submissions will focus on the use of complete diagnostic coding, CPT modifiers and HCPCS Level II codes. The advantages of electronic claims submission will be discussed. Students will learn to complete insurance claim Form 1500, the universally accepted billing format for medical offices. (CSU)

HI 114 C Beginning ICD 10-CM Coding 3 Units

Prerequisite: HI 101 C and HS 145 C and BIOL 210 C all with minimum grades of "C".

Term hours: 36 lecture and 54 laboratory. Principles of nomenclature and classification systems emphasized include ICD 10-CM and ICD 10-PCS. The focus is on coding and abstracting diagnostic and procedural data needed for clinical and administrative decision-making, financial reimbursement and research. (CSU)

HI 115 C Medical Staff Services Science 3 Units

Term hours: 54 lecture. This comprehensive introductory course in fundamental concepts, principles and organization of the hospital and the medical staff services department includes the purpose and role of an organized medical staff; initial staff appointment; reappointment; privilege delineation; preparing agendas and writing minutes; monitoring and documenting proctoring, peer review, and quality review. A primary focus of the course is the guidelines for credentialing of physicians and allied health professionals in not only the hospital but also managed care settings. The organization of health care facilities and interdepartmental relationships are discussed. Emphasis will be placed on standards of voluntary accrediting agencies and regulations of federal and state licensing agencies. This course will provide useful information to the individual responsible for credentialing in a managed care organization and is good preparation for the CPMSM and CPCS credentialing exams. (CSU)

HI 203 C Medical Quality Management 3 Units

Prerequisite: HS 145 C, HI 101 C and HI 103 C all with minimum grades of "C".

Term hours: 36 lecture. This course is an introduction to the principles of the quality management and performance improvement process in health care and provides a framework for gaining skills in collecting, analyzing and presenting data. Course content includes an introduction to quality management techniques and tools, patient safety, hospital and ambulatory accreditation requirements, utilization and risk management. Activities focus on the use of quality improvement tools to collect and present quality management data. (CSU)

HI 204 C Beginning Coding 3 Units

Prerequisite: HS 101 C, HS 145 C, and BIOL 210 C with minimum grades of "C".

Term hours: 36 lecture and 54 laboratory. Principles of nomenclature and classification systems emphasized include ICD-9-CM, ICD 10-CM and ICD 10-PCS. The focus is on coding and abstracting diagnostic and procedural data needed for clinical and administrative decision making, financial reimbursement and research. (CSU)

HI 205 C Directed Practice II 4 Units

Prerequisite: HI 103 C and HI 204 C and counselor approval indicating eligibility to graduate from Health Information Technology Program at the end of the semester.

Term hours: 36 lecture and 108 laboratory. This course will focus on the principles of organization of a health information management department; supervision of human resources in order to develop effective skills in leadership, motivation and team-building techniques; project management and marketing health information management services. Discussions focus on directed practice activities which emphasize the collection, analysis and presentation of health care data; quality improvement functions; and coding and abstracting. During the final semester, students are assigned to an affiliated health-related agency for supervised directed practice. Students shall have the status of learner and shall not be considered agency employees, nor shall they replace agency staff. Directed practice is conducted as a nonpaid, laboratory experience. (CSU)

HI 214 C CPT/Ambulatory Care Coding 3 Units*Prerequisite: HI 114 C.*

Term hours: 36 lecture and 54 laboratory. This course focuses on the principles and mechanics of coding procedures according to Current Procedural Terminology and its relationship to the Health Care Common Procedure Coding System (HCPCS). The course will address the requirements for diagnostic and procedure coding in ambulatory care including hospital outpatient, outpatient surgery and physician office as well as the relationship to outpatient reimbursement methodologies. In the laboratory, students will solve coding problems using operative reports and encoding software. (CSU)

HI 215 C Medical Staff Services Science 2 Units*Prerequisite: HI 115 C.*

Term hours: 36 lecture. Lecture and discussion focuses on selected aspects of medical staff services departmental management and supervision; due process and peer review hearings; and documentation of Medical Executive Committee activities. Throughout the course, there will be advanced review of office management systems. (CSU)

HI 220 C Advanced Coding 3 Units*Prerequisite: HI 204 C and HS 147 C.*

Term hours: 36 lecture and 54 laboratory. Advanced concepts in ICD-9-CM/ICD-10CM & ICD-10-PCS and its application in the prospective payment system are discussed. Lecture will focus on the structure of the Medicare-Severity diagnostic related groups; interpretation of laboratory and radiologic findings; basic pharmacology; and Coding Clinic guidelines. Laboratory activities will include coding actual medical records related to the most common diagnostic related groups using automated encoders. \$3.00 Materials Fee-Payable at Registration. (CSU)

HI 224 C Advanced ICD-10 Coding 3 Units*Prerequisite: HI 114 C and HS 147 C.*

Term hours: 36 lecture and 54 laboratory. Advanced concepts in ICD-10-CM & ICD-10-PCS and its application to the hospital inpatient prospective payment system are discussed. Lecture will focus on the structure of the Medicare-Severity diagnostic related groups; interpretation of laboratory and radiologic findings; pharmacology; and Official Coding Clinic guidelines. Laboratory activities will include coding medical records of the most common diagnostic related groups using automated encoders. \$4.00 Materials Fee - Payable at Registration. (CSU)

HI 225 C Information Technology 3 Units*Prerequisite: CIS 111 C and HI 101 C with minimum grades of "C".*

Term hours: 36 lecture and 54 laboratory. This course explores information and communication technologies used to deliver and document health care that facilitate interoperable health information exchange between and among health care providers. Emphasis is on the implementation of certified electronic health records by hospitals and physicians and how organizations meet the Centers for Medicare and Medicaid Services meaningful use criteria. Discussions focus on personal health records, patient portals, telemedicine, e-prescribing, clinical decision support systems and networking technologies that store, protect, retrieve, and transfer clinical, administrative, and financial information within health care settings. Lab activities center on using electronic health records software; creating and analyzing data in Excel spreadsheets; creating and querying Microsoft Access databases; using Visio and Microsoft Project scheduling tools and evaluating personal health record applications. (CSU)

HI 230 C Directed Practice I 3 Units*Prerequisite: HI 101 C with a minimum grade of "C".*

Term hours: 18 lecture and 108 laboratory. This course investigates the structure and organization of the health information management function in healthcare agencies. A major focus is the development of HIM roles as trainers and patient advocates throughout the healthcare delivery system. Students are assigned to an affiliated health-related agency for supervised directed practice. Students shall have the status of learner and shall not be considered agency employees, nor shall they replace agency staff. Directed practice is conducted as an unpaid, laboratory experience. Directed practice emphasizes working with electronic health record systems and analyzing data in healthcare agencies. (CSU)

HI 240 C Directed Practice II 4 Units*Prerequisite: HI 103 C and HI 114 C with minimum grades of "C".*

Term hours: 36 lecture and 108 laboratory. This course will focus on the basic principles of management; supervision of human resources in order to develop effective skills in leadership, motivation and team-building techniques; project management and marketing health information management services. Discussions focus on directed practice activities which emphasize the collection, analysis and presentation of health care data; quality improvement functions; coding and abstracting; and review for the RHIT credentialing exam. During the semester, students are assigned to an affiliated health-related agency for supervised directed practice. Students shall have the status of learner and shall not be considered agency employees, nor shall they replace agency staff. Directed practice is conducted as an unpaid, laboratory experience. (CSU)

HI 245 C Coding Skills Lab 1 to 2 Units*Prerequisite: Completion of or concurrent enrollment in HI 204 C.*

Term hours: 54-108 laboratory depending on units attempting. The focus of this course is one of assisting the students in the development of coding skills and the application of those skills to different types of medical records. Students will code inpatient, emergency department, outpatient surgery, and referred outpatient medical records using ICD 9-CM, ICD 10-CM, ICD 10-PCS, and the Healthcare Common Procedure Coding System (HCPCS). The process of interpreting medical record information, choosing the required coding classification and assigning and sequencing codes correctly will be addressed. This course will provide an opportunity for students in the Health Information Technology and Health Information Coding Specialist Programs to demonstrate competencies required for completion of each program. Computer assisted instruction and automated encoders will be used within the course. This course may also be taken to update coding skills. May be taken for credit 4 times. Open Entry/Open Exit. Pass/No Pass. \$4.00 Material Fee - Payable at Registration. (CSU)

HI 299 C HI Tech Independent Study .5 to 2 Units*Prerequisite: Approved Independent Study Learning Contract.*

Term hours: 9-36 lecture depending on units attempted. This course is designed for students enrolled in the Health Information Technology program or its options who wish to increase their knowledge and experience in applied areas. Students will participate in independent study in assigned areas under staff supervision. May be taken for credit 4 times. Pass/No Pass/Letter Grade Option. (CSU)

Health Science

Division of Health Science

Division Dean — Rebecca Gomez, Interim

Counselors

Kelly Carter
Denise Vo
Doreen Villaseñor

Health Science (HS)

HS 030 C Calculations for Medications 1 Unit

Advisory: Students should consider this course if they are eligible for admission to the nursing program or psychiatric technician program and/or have had challenges on the math section of the entrance exam, or are in need of updating of math/medication computation skills. MATH 010 C.
Term hours: 18 lecture. This course covers basic math skills, measurement systems and calculation methods involved in safe medication administration to patients. Calculations with decimals, fractions, metric, apothecary, and household systems of measurement will be covered. Ratio and proportion will be used to calculate non-parenteral, parenteral and intravenous infusion dosages/rates. The course will include individual and group experiences with use of a workbook, computer software tutorials, and on-line resources. Non-Degree Credit. Pass/No Pass/Letter Grade Option.

HS 050 C Preparation for Health Science 3 Units

Term hours: 54 lecture. This course is designed for students interested in a health science career. The communication, reading and mathematical skills of students will be developed in relation to the various career needs. Remedial and introductory material necessary to enter and complete a Health Science Program are emphasized. Pass/No Pass/Letter Grade Option.

HS 066 C Selected Topics for NURS 297 C .5 to 2 Units

Prerequisite: Acceptance in the Nursing Program.
Term hours: 9-36 lecture. This course correlates with NURS 297 C. Students will recall and build upon the curricular concepts learning in preceding nursing courses of patient centered care, safety, oxygenation, regulation and movement using teamwork and collaboration, professionalism, evidence based practice, quality improvement and informatics, to apply the nursing process and provide effective care to promote synthesis and competence necessary for entry into practice. Pass/No Pass/Letter Grade Option.

HS 070 C Health Care Communication .5 to 1 Units

Advisory: ESL 184 C.
Term hours: 27-54 laboratory. This course is designed for the non-native speaker to help foster open written and oral communication within the inter-professional team and enhance safe quality patient centered care. Individualized instruction that correlates with the co-enrolled healthcare course of study will be taught. This course is open to students enrolled in any Health Science course or waiting to be re-admitted to a Health Science program. Non-Degree Credit. May be taken for credit 4 times. Open Entry/Open Exit. Pass/No Pass

HS 076 C CPR for Health Care Providers 1 Unit

Term hours: 18 lecture. Basic life support "C" certification is required for health care providers. This class prepares the student with knowledge and skills required to perform adult one-rescuer CPR, adult two-rescuer CPR, pediatric one-rescuer CPR, child two-rescuer CPR, adult foreign body airway management and pediatric foreign body airway management. (The American Heart Association charges a fee for the "C" certification card). Pass/No Pass/Letter Grade Option.

HS 077 C CPR Recertification .5 Units

Prerequisite: Course in Basic Life Support with "C" Certification.
Term hours: 9 lecture. Current BLS "C" certification is required for health care workers when providing direct patient care. This class prepares the student with current knowledge and skills required to obtain a recertification card from the American Heart Association. (The American Heart Association charges a fee for the recertification card). May be taken for credit 4 times. Pass/No Pass/Letter Grade Option.

HS 080 C Selected Topics in Nursing and Allied Health .5 to 8 Units

Term hours: 9-144 lecture depending on units attempted. This course is designed to meet the nursing and allied health science student need for current topics and issues, updated information in health care review of specialized subject matter, and/or preparation for health related licensure and certification exams. Content will emphasize clinical application of theoretical principles in the discipline. Computer software, videotapes, resource materials, instructor assessment of individual student knowledge and skills will be utilized. May be taken for credit 10 times. Pass/No Pass/Letter Grade Option.

HS 098 C Health Science Seminar .5 to 12 Units

Prerequisite: May be required.
Corequisite: May be required.
Advisory: May be required.
Term hours: 0-216 lecture and/or 0-648 laboratory depending on units attempted. This class will utilize a lecture discussion approach to various topics within the Health Science programs. A variety of classes will be offered to introduce students to new experiences, update content on current issues, and explore new trends in health care. Fees may be required-Payable at Registration. May be taken for credit 1-4 times. Pass/No Pass or Pass/No Pass/Letter Grade Option or Standard Letter Grade.

HS 099 C Health Science Independent Study .5 to 2 Units

Prerequisite: Approved Independent Study Learning Contract.
Term hours: Lecture hours vary according to credit given. This course is designed for students interested in health science programs who wish to increase their knowledge and experience in applied areas. Students will participate in independent study on assigned areas under staff supervision. May be taken for credit 4 times. Pass/No Pass/Letter Grade Option.

HS 145 C Survey of Medical Terminology 3 Units

Term hours: 54 lecture. This course includes fundamentals of word analysis, roots, prefixes and suffixes in an orientation to the body as a whole. A survey of medical terminology of the following body systems includes: skin and breast, musculoskeletal, neurological/psychiatric, cardiovascular, respiratory, digestive, genitourinary, prenatal, maternal, endocrine, and special senses. Anatomical and physiologic terminology, combining forms, diagnostic terms, clinical and surgical procedures, laboratory tests and abbreviations are included. A basic requirement for most career opportunities in the allied health occupations and in the court systems is the comprehension of medical terminology. (CSU)

HS 147 C Survey of Disease 3 Units

Prerequisite: HS 145 C and BIOL 210 C or BIOL 231 C or BIOL 241 C with minimum grades of "C".
Term hours: 54 lecture. This course is a comprehensive survey of pathophysiology focusing on how diseases affect human body function along with diagnostic and therapeutic interventions. It includes chronic and degenerative diseases; cardiac, respiratory, hematologic, musculoskeletal, gastrointestinal, genitourinary and reproductive system disorders; genetic disorders; infectious diseases; neoplasia; and fluid, electrolyte and acid-base imbalance disorders. (CSU)

HS 161 C Dying/Death and Grief/Mourning 3 Units

Same as HSCE 161 C

Term hours: 54 lecture. This course is designed to assist individuals in such areas as personal death anxiety and working/living with the terminally ill person. Discussion includes special concerns such as how to handle grief, suicide, hospice, and other related topics. (CSU)

HS 165 C Ethical and Legal Issues 1.5 Units

Term hours: 27 lecture. This course will focus on making ethical choices in health care. An introduction to legal terminology, concepts, and principles will be presented. Topics include misconduct, malpractice, legal and professional standards and the scope of practice. The importance of proper documentation and informed consent is emphasized. The student will examine a variety of ethical issues and dilemmas found in clinical practice. The rights and responsibilities of patients and health care professionals will be examined. (CSU)

HS 168 C Patient Care Skills - Open Lab .5 to 3 Units

Prerequisite: Current first year Health Science program student or approved re-entry students needing remedial assistance or current professional license related to a health science program.

Term hours: 27-162 laboratory depending on units attempted. This open-entry, open-exit course with flexible hours and variable units allows self-paced individualized instruction and/or practice in basic patient centered care skills with Health Science faculty supervision. The course provides students with space, equipment and resources needed to learn skills and apply theory surrounding patient safety, oxygenation, regulation and movement with teamwork, collaboration, professionalism, evidence based practice and informatics to prepare for quality clinical experiences towards positive patient outcomes. \$15.00 Material Fee-Payable at Registration. May be taken for credit 4 times. Open Entry/Open Exit. Pass/No Pass only. (CSU)

HS 268 C Patient Care Skills - Open Lab .5 to 3 Units

Prerequisite: Current second year Health Science program student or re-entry students needing remedial assistance or health care professional seeking an environment to practice advanced health science skills.

Advisory: BIOL 241 C, BIOL 220 C, BIOL 231 C and ENGL 100 C.

Term hours: 27-162 laboratory depending on units attempted. This open-entry, open-exit course with flexible hours and variable units allows self-paced individualized instruction and/or practice in advanced patient centered care skills with Health Science faculty supervision. The course provides students with space, equipment and resources needed to learn skills and apply theory surrounding patient safety, oxygenation, regulation and movement with teamwork, collaboration, professionalism, evidence based practice and informatics to prepare for quality clinical experiences towards positive patient outcomes. May be taken for credit 4 times. Open Entry/Open Exit. Pass/No Pass only. \$15.00 Material Fee-Payable at Registration. (CSU)

HS 277 C Cultural Awareness and the Health Care System 3 Units

Term hours: 54 lecture. This course is designed to examine how cultural differences impact health care and health care delivery. The influence of multi-ethnic cultures on health care concepts, intervention, and the delivery of health care will be discussed. The course will emphasize communication, beliefs and customs, cultural rituals, ethical and legal implications and staff relations in our multi-ethnic health care system. The content focuses on expanding sensitivity to cultural diversity in health care and includes medical, social, and legal issues. (CSU, AA GE, CSU GE, CUL DIV)

Health Science — Continuing Education

Division of Health Science

Division Dean — Rebecca Gomez, Interim

Faculty

Health Science Instructors

Counselors

Kelly Carter

Denise Vo

Doreen Villaseñor

Provider approved by the California Board of Registered Nursing — Provider Number 00110, for the number of contact hours the class meets. Request list of approved classes from the Health Science Division.

Health Science — Continuing Education (HSCE)

HSCE 161 C Dying/Death and Grief/Mourning 3 Units

Same as HS 161 C

Term hours: 54 lecture/discussion. This course is designed to assist individuals in such areas as personal death anxiety and working/living with the terminally ill person. Discussion includes special concerns such as how to handle grief, suicide, hospice, and other related topics. (CSU)

History

Division of Social Sciences

Division Dean — Lisa Gaetje, Interim

Faculty

Michael Flores

David Halahmy

Carol Elsensohn Lewis

Bryan Seiling

Counselors

Therese Mosqueda-Ponce

Daniel Pelletier

PROGRAM LEARNING OUTCOMES (PLOs)

The courses taught by this department contribute to the General Education and Basic Skills Program Learning Outcomes. Please refer to General Education and Basic Skills Program Learning Outcomes.

HISTORY TRANSFER PROGRAM

Students should consult a counselor or www.assist.org for lower division major requirements for most California public universities. (See the Standard Definitions section of the catalog for a description of ASSIST.) Students transferring to an independent college/university should consult the catalog of the individual school and a counselor for lower division major requirements.

ASSOCIATE IN ARTS IN HISTORY FOR TRANSFER DEGREE (AA-T)

Program Code: 1A31266

This curriculum is designed to provide an opportunity for the History major to achieve an Associate in Arts Degree in History for Transfer (AA-T in History) which completes the first and second year requirements for transfer to a four-year public California institution. While at least a baccalaureate degree is recommended preparation for those considering professional careers, completion of this curriculum will demonstrate commitment to the field and provide comprehensive preparation for further academic study through upper-division course work. This curriculum specifically prepares the prospective transfer student for upper division course work in History or a similar major at a California State University (CSU) campus. Students should consult a counselor, the Transfer Center and the catalog of the transfer college or university to plan a specific program of study to meet the college or university's requirements.

Note: Courses that fulfill major requirements for an Associate Degree for Transfer at Cypress College might not be the same as those required for completing the major at all transfer institutions offering a Baccalaureate Degree. The Student Transfer Achievement Reform Act (Senate Bill 1440, now codified in California Education Code sections 66746–66749) guarantees admission to a California State University (CSU) campus for any community college student who completes an “associate degree for transfer,” a newly established variation of the associate degrees traditionally offered at a California community college. The AA-T is intended for students who plan to complete a bachelor's degree in a similar major at a CSU campus. Students completing these degrees (AA-T) are guaranteed admission to the CSU system, but not to a particular campus or major. Students transferring to a CSU campus that does accept the AA-T will be required to complete no more than 60 units after transfer to earn a bachelor's degree (unless the major is designated a “high-unit” major). This degree may not be the best option for students intending to transfer to a particular CSU campus or to a university or college that is not part of the CSU system. Students should consult with a counselor when planning to complete the degree for more information on university admission and transfer requirements. History is the study of change over time. Historians analyze cause and effect, construct narratives from primary sources, and try to explain the actions of people in the past. Students in history courses learn more than dates, names, and events. They also learn how to interpret, debate, and draw conclusions. History majors acquire a broad perspective on the human experience and appreciate how the past has shaped the present. While a baccalaureate degree is still recommended, completion of this degree is excellent general preparation for careers in education, law, historical research, historical preservation, government, journalism, media, and communication.

To earn an AA-T in History students must complete the following requirements: (1) a minimum of 18 semester units or 27 quarter units in the History major with a minimum grade of “C”; (2) California State University General Education Breadth requirements (CSU GE Breadth) or the Intersegmental General Education Transfer Curriculum (IGETC); (3) elective courses to complete a minimum of 60 units of CSU transferable course work; (4) have an overall GPA of 2.0.

| | | Units |
|---|--|--------------|
| Required Core: 6 units | | |
| HIST 170 C | History of the United States I or | 3 |
| HIST 170HC | Honors History of the United States I and | (3) |
| HIST 171 C | History of the United States II or | 3 |
| HIST 171HC | Honors History of the United States II | (3) |
| List A: 6 units chosen. Students will need to take either HIST 110 C/110HC or HIST 112 C/112HC and HIST 111 C/111HC or HIST 113 C/113HC. | | |
| HIST 110 C | Western Civilizations I or | 3 |
| HIST 110HC | Honors Western Civilizations I or | (3) |
| HIST 112 C | World Civilizations I or | (3) |
| HIST 112HC | Honors World Civilizations I and | (3) |
| HIST 111 C | Western Civilizations II or | 3 |
| HIST 111HC | Honors Western Civilizations II or | (3) |
| HIST 113 C | World Civilizations II or | (3) |
| HIST 113HC | Honors World Civilizations II | (3) |
| List B Group 1: Select 3 units from the following: Any History course not pertaining to the U.S. or Europe. (History 112 C/112HC and 113 C/113HC may be taken if not used in List A) | | |
| HIST 112 C | World Civilizations I | 3 |
| HIST 112HC | Honors World Civilizations I | 3 |
| HIST 113 C | World Civilizations II | 3 |
| HIST 113HC | Honors World Civilizations II | 3 |
| HIST 135 C | History of Africa | 3 |
| HIST 142 C | History of Latin America I | 3 |
| HIST 143 C | History of Latin America II | 3 |
| HIST 160 C | Asian Civilizations I | 3 |
| HIST 161 C | Asian Civilizations II | 3 |
| HIST 165 C | History of the Middle East | 3 |
| List B Group 2: 3 units: Any history course (may be taken if not used from List A or from List B Group 1) | | |
| HIST 110 C | Western Civilizations I | 3 |
| HIST 110HC | Honors Western Civilizations I | 3 |
| HIST 111 C | Western Civilizations II | 3 |
| HIST 111HC | Honors Western Civilizations II | 3 |
| HIST 112 C | World Civilizations I | 3 |
| HIST 112HC | Honors World Civilizations I | 3 |
| HIST 113 C | World Civilizations II | 3 |
| HIST 113HC | Honors World Civilizations II | 3 |
| HIST 135 C | History of Africa | 3 |
| HIST 142 C | History of Latin America I | 3 |
| HIST 143 C | History of Latin America II | 3 |
| HIST 151 C | Survey of British History I | 3 |
| HIST 152 C | Survey of British History II | 3 |
| HIST 160 C | Asian Civilizations I | 3 |
| HIST 161 C | Asian Civilizations II | 3 |
| HIST 162AC | History of the Americas I | 3 |
| HIST 162BC | History of the Americas II | 3 |
| HIST 163 C | History of Mexico | 3 |
| HIST 165 C | History of the Middle East | 3 |
| HIST 270 C | Women in United States History | 3 |
| HIST 275 C | History of California | 3 |
| Total Units Required | | 18 |

History (HIST)

HIST 110 C Western Civilizations I 3 Units

Advisory: Eligibility for ENGL 100 C.

Term hours: 54 lecture. This course is a comprehensive study of the contributions of previous civilizations from prehistoric times to the beginning of the modern era. The development of the present day Western mind and institutions is traced by analyzing the beliefs, myths, accomplishments and problems of the civilizations of Mesopotamia, Egypt, Greece, Rome, the Medieval Period, Renaissance and Reformation. Duplicate credit not granted for HIST 110HC. (UC Credit Limitation/CSU, AA GE, CSU GE, IGETC, C-ID: HIST 170)

HIST 110HC Honors Western Civilizations I 3 Units

Advisory: Eligibility for ENGL 100 C.

Term hours: 54 lecture. This course is an enhanced comprehensive study of the contributions of previous civilizations from prehistoric times to the beginning of the modern era. The development of the present day Western mind and institutions is traced by analyzing the beliefs, myths, accomplishments and problems of the civilizations of Mesopotamia, Egypt, Greece, Rome, the Medieval Period, Renaissance and Reformation. Duplicate credit not granted for HIST 110 C. (UC Credit Limitation/CSU, AA GE, CSU GE, IGETC, C-ID: HIST 170)

HIST 111 C Western Civilizations II 3 Units

Advisory: Eligibility for ENGL 100 C.

Term hours: 54 lecture. This course covers the development of Western civilization from the beginning of the modern era to the present day. A major part of this course deals with the twentieth century. It covers monarchies, imperialism, scientific and industrial contributions, modern political ideologies and the World Wars with related political-social, and cultural issues. Duplicate credit not granted for HIST 111HC. (UC Credit Limitation/CSU, AA GE, CSU GE, IGETC, C-ID: HIST 180)

HIST 111HC Honors Western Civilizations II 3 Units

Advisory: Eligibility for ENGL 100 C.

Term hours: 54 lecture. This course covers the development of Western civilization from the beginning of the modern era to the present day. A major part of this course deals with the twentieth century. It covers monarchies, imperialism, scientific and industrial contributions, modern political ideologies and the World Wars with related political, social, and cultural issues. Duplicate credit not granted for HIST 111 C. (UC Credit Limitation/CSU, AA GE, CSU GE, IGETC, C-ID: HIST 180)

HIST 112 C World Civilizations I 3 Units

Advisory: Eligibility for ENGL 100 C.

Term hours: 54 lecture. This course is a survey of the roots and development of civilizations in Africa, the Americas, Asia, and Europe from the earliest times to 1550 CE. Duplicate credit not granted for HIST 112HC. (UC Credit Limitation/CSU, AA GE, CSU GE, IGETC)

HIST 112HC Honors World Civilizations I 3 Units

Advisory: Eligibility for ENGL 100 C.

Term hours: 54 lecture. This course is an enhanced survey of the roots and development of the various civilizations in Africa, the Americas, Asia, and Europe from the earliest times to 1550 CE. Duplicate credit not granted for HIST 112 C. (UC Credit Limitation/CSU, AA GE, CSU GE, IGETC)

HIST 113 C World Civilizations II 3 Units

Advisory: Eligibility for ENGL 100 C.

Term hours: 54 lecture. This course is a survey of the roots and development of civilizations in Africa, the Americas, Asia, and Europe from 1550 CE to the present. Duplicate credit not granted for HIST 113HC. (UC Credit Limitation/CSU, AA GE, CSU GE, IGETC, C-ID: HIST 160)

HIST 113HC Honors World Civilizations II 3 Units

Advisory: Eligibility for ENGL 100 C.

Term hours: 54 lecture. This course is an enhanced survey of the roots and development of civilizations in Africa, the Americas, Asia, and Europe from 1550 CE to the present. Duplicate credit not granted for HIST 113 C. (UC Credit Limitation/CSU, AA GE, CSU GE, IGETC, C-ID: HIST 160)

HIST 135 C History of Africa 3 Units

Advisory: Eligibility for ENGL 100 C.

Term hours: 54 lecture. This course is a survey of the history of Africa from the continent's earliest beginnings to contemporary times. A special emphasis is placed on the various cultures of Africa, demography and general chronology of the rise and fall of nation states, and the impact of Western culture through the colonial, neo-colonial, and contemporary periods. (UC/CSU, AA GE, CSU GE, IGETC)

HIST 142 C History of Latin America I 3 Units

Advisory: Eligibility for ENGL 100 C.

Term hours: 54 lecture. This course is a survey of the history of Latin America from the late pre-Columbian era to the independence period. Emphasis is placed upon European conquest, the interaction of Europeans with Native American and African cultures, and the planting of colonial societies in the regions of Mexico, Central America, the Caribbean, and South America. Spanish, French, Portuguese, British, and Dutch America are compared as to their socio-cultural, economic, and political development during the colonial and independence periods. (UC/CSU, AA GE, CSU GE)

HIST 143 C History of Latin America II 3 Units

Advisory: Eligibility for ENGL 100 C.

Term hours: 54 lecture. This course is a survey of the history of Latin America from the independence period to the present. Emphasis is placed upon: the nation-building process, integration into the world capitalist system, the inequality between the elite classes and the masses, the development of new groups, such as the urban middle and working classes, the conflict between liberalism and the Catholic Church, race relations, challenges of political regimes, relationships during the Cold War, and the new global economic models. (UC/CSU, AA GE, CSU GE, IGETC)

HIST 151 C Survey of British History I 3 Units

Advisory: Eligibility for ENGL 100 C.

Term hours: 54 lecture. This course is a survey of English history and civilizations from prehistoric times to the end of the Stuart period. The course concentrates on the development of governmental institutions, and the cultural and intellectual foundations of England and its people. (UC/CSU, AA GE, CSU GE, IGETC)

HIST 152 C Survey of British History II 3 Units

Advisory: Eligibility for ENGL 100 C.

Term hours: 54 lecture. This course is the continuing survey of the development of the United Kingdom from 1715 to the present. Special emphasis in this course will be placed on England's political and cultural expansion around the globe. (UC/CSU, AA GE, CSU GE, IGETC)

HIST 160 C Asian Civilizations I 3 Units

Advisory: Eligibility for ENGL 100 C.

Term hours: 54 lecture. This course is a comparative history of the civilizations of Asia from their birth to the 19th century. It explores the social, cultural, political, and economic developments of East, South, and Southeast Asian countries. Pass/No Pass/Letter Grade Option. (UC/CSU, AA GE, CSU GE, IGETC)

HIST 161 C Asian Civilizations II **3 Units***Advisory: Eligibility for ENGL 100 C.*

Term hours: 54 lecture. This course is a comparative history of the civilizations of Asia from the 19th century to the present. It explores the social, cultural, political, and economic developments of East, South, and Southeast Asian countries. Pass/No Pass/Letter Grade Option. (UC/CSU, AA GE, CSU GE, IGETC)

HIST 163 C History of Mexico **3 Units***Advisory: Eligibility for ENGL 100 C.*

Term hours: 54 lecture. This course is a survey of the economic, socio-cultural and political history of Mexico from the pre-Columbian period to the present. (UC/CSU, AA GE, CSU GE, IGETC)

HIST 165 C History of the Middle East **3 Units***Advisory: Eligibility for ENGL 100 C.*

Term hours: 54 lecture. This course covers the historical development of the Middle East from the rise of Middle Eastern civilization to the present. Emphasis will be placed on the Jewish and Islamic religions, as well as the key political and social conflicts through modern times in the region. (UC/CSU, AA GE, CSU GE, IGETC)

HIST 170 C History of the United States I **3 Units***Advisory: Eligibility for ENGL 100 C.*

Term hours: 54 lecture. This course is a survey of American history from the colonial foundations to 1877. The course satisfies state requirements in American history and institutions for transfer. Duplicate credit not granted for HIST 170HC. (UC Credit Limitation/CSU, AA GE, CSU GE, IGETC, C-ID: HIST 130)

HIST 170HC Honors History of the United States I **3 Units***Advisory: Eligibility for ENGL 100 C.*

Term hours: 54 lecture. This course is an enhanced survey of American history from the colonial foundations to 1877. This course satisfies state requirements in American history and institutions for transfer. Duplicate credit not granted for HIST 170 C. (UC Credit Limitation/CSU, AA GE, CSU GE, IGETC, C-ID: HIST 130)

HIST 171 C History of the United States II **3 Units***Advisory: Eligibility for ENGL 100 C.*

Term hours: 54 lecture. This course is a survey of American history from 1877 to the present. This course satisfies state requirement in American history and institutions for transfer. Duplicate credit not granted for HIST 171HC. (UC Credit Limitation/CSU, AA GE, CSU GE, IGETC, C-ID: HIST 140)

HIST 171HC Honors History of the United States II **3 Units***Advisory: Eligibility for ENGL 100 C.*

Term hours: 54 lecture. This course is an enhanced survey of American History from 1877 to the present. This course satisfies state requirements in American History and institutions for transfer. Duplicate credit will not be granted for HIST 171 C. (UC Credit Limitation/CSU, AA GE, CSU GE, IGETC)

HIST 190 C History of the Americas I **3 Units**

Formerly HIST 162AC

Advisory: Eligibility for ENGL 100 C.

Term hours: 54 lecture. This course is a survey of the history of the Western hemisphere from its discovery to the wars of independence. Emphasis is placed upon European conquest, the interaction of Europeans with Native American and African cultures, and the planting of colonial societies in the New World. Spanish America, Brazil, Canada, and the United States are compared as to their socio-cultural, economic, and political development during the colonial and independence periods. (UC/CSU, AA GE, CSU GE, IGETC)

HIST 191 C History of the Americas II **3 Units**

Formerly HIST 162BC

Advisory: Eligibility for ENGL 100 C.

Term hours: 54 lecture. This course is a comparative study of the political, social, and economic development of the independent nations of the Western hemisphere from the wars of independence to the present. Emphasis is placed upon the present international relations of these nations. (UC/CSU, AA GE, CSU GE, IGETC)

HIST 270 C Women in United States History **3 Units***Advisory: Eligibility for ENGL 100 C.*

Term hours: 54 lecture. This course is a survey of the economic, social, intellectual and political history of women in America from colonial times to the present. Special emphasis is placed upon the feminist movements and the suffrage struggle of the 19th and 20th centuries. (UC/CSU, AA GE, CSU GE, IGETC)

HIST 275 C History of California **3 Units***Advisory: Eligibility for ENGL 100 C.*

Term hours: 54 lecture. This course surveys the economic, social, ethnic, intellectual, and political history of California from the earliest times to the present. Special emphasis is placed upon issues of diversity caused by demographic changes. (UC/CSU, CSU GE, IGETC, CUL DIV)

HIST 295 C Research Methods-Oral History **2 Units**

Same as SOSC 295 C

Term hours: 18 lecture and 54 laboratory. This course introduces the student to the special techniques of tape recorded interviews to document 20th century history. Areas of study will include interviewing techniques, historical editing, and transcripts of interviews. The course does not satisfy General Education requirements in Social Science. (CSU)

HIST 298 C History Seminar **.5 to 12 Units***Prerequisite: May be required.**Corequisite: May be required.**Advisory: May be required.*

Term hours: 0-216 lecture and/or 0-648 laboratory. This is a lecture/discussion type course developed on a particular limited problem or topic of interest to students. It is designed for able students who wish to increase their knowledge of a particular topic concerning which no other regular class is offered. A paper or group activity may be requested. Credit may range from 1/2 unit to 12 units. Consult class schedule for the offerings a particular semester. May be taken for credit 1-4 times. Pass/No Pass/or Pass/No Pass/Letter Grade Option or Standard Letter Grade. Fees may be required-Payable at Registration. (UC Credit Limitation/CSU)

HIST 299 C History Independent Study **1 Unit***Prerequisite: Approved Independent Study Learning Contract.*

May be taken for credit 3 times.

Varying hours of scheduled conferences per week according to instructor. Independent study is for able students who wish to extend their knowledge of a particular area through individual research and study. It is thought that topics might develop out of a curiosity stimulated in a regular class. The student would then contact the supervising instructor to develop a contract for his/her particular interest so that they could learn more regarding their special topic. (UC Credit Limitation/CSU)

Hotel, Restaurant, Culinary Arts

Division of Career Technical Education

Division Dean — Kathleen Reiland, Interim

Faculty

Lisa Clark

Jeremy Peters

Stephanie Rosati

Counselor

Jane Jepson

PROGRAM LEARNING OUTCOMES (PLOs)

Hotel, Restaurant and Culinary Arts

A Cypress College student who earns a Certificate from the Hotel, Restaurant, Culinary Arts program in Hotel Management, Foodservice Management or Culinary Arts will:

- Acquire the necessary skills for hospitality/culinary arts employment to include demonstrated ability in effective communications, customer service, teamwork, cost control, ethical considerations, critical thinking and leadership
- Demonstrate competencies required for hospitality/culinary employment to include sanitation and safety, nutrition, restaurant and hotel operations, and specialized culinary techniques
- Enhance his/her career and educational opportunities within the hospitality and culinary industry

ASSOCIATE IN SCIENCE DEGREE

CULINARY ARTS Program Code: 1S03813

The Culinary Arts program provides students with fundamentals in the methods of food safety, handling, preparation, and kitchen management. It includes exposure to various styles of cuisines, and proper use of culinary applications and equipment. The program is designed to help students develop a working knowledge of what is required to be successful in the fast pace culinary industry.

To earn an Associate Degree students must complete all graduation requirements to include: (1) all major course requirements with a “C” or better; (2) 25 units of General Education Graduation Requirements; (3) the cultural diversity and reading requirements; (4) any elective courses to complete a minimum of 60 units; and, (5) have a minimum GPA of 2.0. At least 50% of all major course work must be completed at Cypress College. Courses that fulfill major requirements for an Associate Degree at Cypress College might not be the same as those required for completing the major at a transfer institution offering a Baccalaureate Degree. For information on specific university requirements, please consult with your counselor, or visit the Transfer Center.

| Required courses are listed in suggested sequence: | | Units |
|---|-------------------------------------|--------------|
| HRC 100 C | Nutrition | 3 |
| HRC 101 C | Introduction to Hospitality Careers | 3 |
| HRC 120 C | Sanitation and Safety | 3 |
| HRC 125 C | Restaurant Management | 3 |
| HRC 135 C | Culinary Fundamentals I | 3 |
| HRC 136 C | Baking Fundamentals I | 3 |
| HRC 145 C | The Art of Garde Manger | 3 |
| HRC 152 C | Hospitality Purchasing | 3 |
| HRC 231 C | Cost Control in Hospitality | 3 |
| HRC 235 C | Culinary Fundamentals II | 3 |
| HRC 255 C | American Regional Cuisine | 3 |
| HRC 290 C | Hospitality Career Capstone | 3 |
| Total Units Required | | 36 |

CULINARY ARTS CERTIFICATE

Program Code: 1C21119

The Culinary Arts program provides students with basic competencies in the methods of food handling, cooking, and culinary management. It includes exposure to various styles, and proper use of culinary applications and equipment. The program is designed to help students develop a working knowledge of what is required to be successful for fast track culinary management potential.

To earn a certificate, complete the required courses as listed with a minimum grade of “C.” At least 50% of all course work must be completed at Cypress College.

| Required courses are listed in suggested sequence: | | Units |
|---|-------------------------------------|--------------|
| HRC 100 C | Nutrition | 3 |
| HRC 101 C | Introduction to Hospitality Careers | 3 |
| HRC 120 C | Sanitation and Safety | 3 |
| HRC 125 C | Restaurant Management | 3 |
| HRC 135 C | Culinary Fundamentals I | 3 |
| HRC 136 C | Baking Fundamentals I | 3 |
| HRC 145 C | The Art of Garde Manger | 3 |
| HRC 152 C | Hospitality Purchasing | 3 |
| HRC 231 C | Cost Control in Hospitality | 3 |
| HRC 235 C | Culinary Fundamentals II | 3 |
| HRC 255 C | American Regional Cuisine | 3 |
| HRC 290 C | Hospitality Career Capstone | 3 |
| Total Units Required | | 36 |

ASSOCIATE IN SCIENCE DEGREE

BAKING AND PASTRY ARTS

Program Code: 1S31170

The Baking and Pastry Arts program provides students with a broad and thorough foundation in the art of pastry and baking, from bread to chocolate to ice cream, and everything in between. The program is designed to help students develop a working knowledge of what is required to be successful in the fast pace culinary industry.

To earn an Associate Degree students must complete all graduation requirements to include: (1) all major course requirements with a “C” or better; (2) 25 units of General Education Graduation Requirements; (3) the cultural diversity and reading requirements; (4) any elective courses to complete a minimum of 60 units; and, (5) have a minimum GPA of 2.0. At least 50% of all major course work must be completed at Cypress College. Courses that fulfill major requirements for an Associate Degree at Cypress College might not be the same as those required for completing the major at a transfer institution offering a Baccalaureate Degree. For information on specific university requirements, please consult with your counselor, or visit the Transfer Center.

Required courses are listed in suggested sequence:

| | | |
|-----------------------------|-------------------------------------|-----------|
| HRC 100 C | Nutrition | 3 |
| HRC 101 C | Introduction to Hospitality Careers | 3 |
| HRC 120 C | Sanitation and Safety | 3 |
| HRC 135 C | Culinary Fundamentals I | 3 |
| HRC 136 C | Baking Fundamentals I | 3 |
| HRC 152 C | Hospitality Purchasing | 3 |
| HRC 231 C | Cost Control in Hospitality | 3 |
| HRC 232 C | Special Event Management | 3 |
| HRC 236 C | Baking Fundamentals II | 3 |
| HRC 246 C | Pastry Arts | 3 |
| HRC 255 C | American Regional Cuisine | 3 |
| HRC 290 C | Hospitality Career Capstone | 3 |
| Total Units Required | | 36 |

BAKING AND PASTRY ARTS CERTIFICATE **Program Code: 1C31172**

The Baking and Pastry Arts program provides students with a broad and thorough foundation in the art of pastry and baking, from bread to chocolate to ice cream, and everything in between. The program is designed to help students develop a working knowledge of what is required to be successful in the fast paced culinary industry.

To earn a certificate, complete the required courses as listed with a minimum grade of "C." At least 50% of all course work must be completed at Cypress College.

Required courses are listed in suggested sequence:

| | | |
|-----------------------------|-------------------------------------|-----------|
| HRC 100 C | Nutrition | 3 |
| HRC 101 C | Introduction to Hospitality Careers | 3 |
| HRC 120 C | Sanitation and Safety | 3 |
| HRC 135 C | Culinary Fundamentals I | 3 |
| HRC 136 C | Baking Fundamentals I | 3 |
| HRC 152 C | Hospitality Purchasing | 3 |
| HRC 231 C | Cost Control in Hospitality | 3 |
| HRC 232 C | Special Event Management | 3 |
| HRC 236 C | Baking Fundamentals II | 3 |
| HRC 246 C | Pastry Arts | 3 |
| HRC 255 C | American Regional Cuisine | 3 |
| HRC 290 C | Hospitality Career Capstone | 3 |
| Total Units Required | | 36 |

BAKING FUNDAMENTALS CERTIFICATE **Program Code: 1C12968**

This two semester certificate program is designed to provide the student with fundamental knowledge and techniques of baking and pastry, food safety, an understanding of the complexity of kitchen operations and an appreciation of the hospitality industry.

Graduates will gain the knowledge and applied skills required to enter the hospitality industry as a baker or pastry cook.

To earn a certificate, complete the required courses as listed with a minimum grade of "C." At least 50% of all course work must be completed at Cypress College.

Required courses are listed in suggested sequence:

| | | |
|-----------------------------|-------------------------------------|-----------|
| HRC 101 C | Introduction to Hospitality Careers | 3 |
| HRC 120 C | Sanitation and Safety | 3 |
| HRC 136 C | Baking Fundamentals I | 3 |
| HRC 236 C | Baking Fundamentals II | 3 |
| HRC 246 C | Pastry Arts | 3 |
| Total Units Required | | 15 |

CULINARY FUNDAMENTALS CERTIFICATE **Program Code: 1C12969**

This two semester certificate program is designed to provide the student with fundamental knowledge and techniques of food preparation, food safety, an understanding of the complexity of kitchen operations and an appreciation of the hospitality industry.

Graduates will gain the knowledge and applied skills required to enter the hospitality industry as a cook.

To earn a certificate, complete the required courses as listed with a minimum grade of "C." At least 50% of all course work must be completed at Cypress College.

Required courses are listed in suggested sequence:

| | | |
|-----------------------------|-------------------------------------|-----------|
| HRC 101 C | Introduction to Hospitality Careers | 3 |
| HRC 120 C | Sanitation and Safety | 3 |
| HRC 135 C | Culinary Fundamentals I | 3 |
| HRC 145 C | The Art of Garde Manger | 3 |
| HRC 235 C | Culinary Fundamentals II | 3 |
| Total Units Required | | 15 |

ASSOCIATE IN SCIENCE DEGREE FOOD AND BEVERAGE MANAGEMENT **Program Code: 1S07848**

The Associate of Science Degree in Food and Beverage Management offers comprehensive coursework in restaurant management, beverage operations, managed food services and special events. Coursework emphasizes the role of guest services, effective oral and written communication, teamwork, management and leadership strategies, ethical decision-making and critical thinking. Students will prepare for a career in the growing restaurant and food service industry and/or to transfer to a four-year university.

To earn an Associate Degree students must complete: (1) all major course requirements with a "C" or better; (2) 25 units of General Education Graduation Requirements; (3) the cultural diversity and reading requirements; (4) any elective courses to complete a minimum of 60 units; and, (5) have a minimum GPA of 2.0. At least 50% of all major course work must be completed at Cypress College.

Courses that fulfill major requirements for an Associate Degree at Cypress College might not be the same as those required for completing the major at a transfer institution offering a Baccalaureate Degree. For information on specific university requirements, please consult with your counselor, or visit the Transfer Center.

Required courses are listed in suggested sequence:

| Course # | Title | Units |
|-----------------------------|-------------------------------------|-----------|
| HRC 100 C | Nutrition | 3 |
| HRC 101 C | Introduction to Hospitality Careers | 3 |
| HRC 120 C | Sanitation and Safety | 3 |
| HRC 125 C | Restaurant Management | 3 |
| HRC 135 C | Culinary Fundamentals I | 3 |
| HRC 152 C | Hospitality Purchasing | 3 |
| HRC 164 C | Hospitality Law | 3 |
| HRC 170 C | Beverage Management | 3 |
| HRC 230 C | Hospitality Leadership | 3 |
| HRC 231 C | Cost Control in Hospitality | 3 |
| HRC 232 C | Special Event Management | 3 |
| HRC 290 C | Hospitality Career Capstone | 3 |
| Total Units Required | | 36 |

FOOD AND BEVERAGE MANAGEMENT CERTIFICATE

Program Code: 1C21120

The Food and Beverage Management Certificate offers coursework in restaurant management, beverage operations, managed food services and special events. Coursework emphasizes the role of guest services, effective oral and written communication, teamwork, management and leadership strategies, ethical decision-making and critical thinking. Students will prepare for a career in the growing restaurant and food service industry.

To earn a certificate, students must complete the required courses as listed with a “C” or better. At least 50% of all course work must be completed at Cypress College.

Required courses are listed in suggested sequence:

| Course # | Title | Units |
|-----------------------------|-------------------------------------|-----------|
| HRC 100 C | Nutrition | 3 |
| HRC 101 C | Introduction to Hospitality Careers | 3 |
| HRC 120 C | Sanitation and Safety | 3 |
| HRC 125 C | Restaurant Management | 3 |
| HRC 135 C | Culinary Fundamentals I | 3 |
| HRC 152 C | Hospitality Purchasing | 3 |
| HRC 164 C | Hospitality Law | 3 |
| HRC 170 C | Beverage Management | 3 |
| HRC 230 C | Hospitality Leadership | 3 |
| HRC 231 C | Cost Control in Hospitality | 3 |
| HRC 232 C | Special Event Management | 3 |
| HRC 290 C | Hospitality Career Capstone | 3 |
| Total Units Required | | 36 |

FOOD SERVICE FUNDAMENTALS CERTIFICATE

Program Code: 1C12979

The Food Service Fundamentals Certificate provides students with an opportunity to obtain the foundational skills and practical knowledge for pursuing an entry-level career in the diverse food service industry. Students completing this certificate will develop an understanding of the role of nutrition, sanitation and safety, culinary fundamentals and cost control in food service operations.

To earn a certificate, students must complete the required courses as listed with a minimum grade of “C.” At least 50% of all course work must be completed at Cypress College.

Required courses are listed in suggested sequence:

| Course # | Title | Units |
|-----------------------------|-------------------------------------|-----------|
| HRC 100 C | Nutrition | 3 |
| HRC 101 C | Introduction to Hospitality Careers | 3 |
| HRC 120 C | Sanitation and Safety | 3 |
| HRC 135 C | Culinary Fundamentals I | 3 |
| HRC 231 C | Cost Control in Hospitality | 3 |
| Total Units Required | | 15 |

ASSOCIATE IN SCIENCE DEGREE HOSPITALITY MANAGEMENT

Program Code: 1S03763

The Associate in Science Degree in Hospitality Management offers comprehensive coursework in rooms operations, revenue management, food and beverage management, special events, purchasing, law, cost control, human resources, and sales and marketing. Coursework emphasizes the role of guest services, effective oral and written communication skills, teamwork, management and leadership strategies, ethical decision making and critical thinking. Students will prepare for careers in the dynamic hospitality industry and/or transfer to a four year university.

To earn an Associate Degree, students must complete all graduation requirements to include (1) all major course requirements with a “C” or better; (2) 25 units of General Education Graduation Requirements; (3) the cultural diversity and reading requirements; (4) any elective courses to complete a total of 60 units; and, (5) have a minimum GPA of 2.0. At least 50% of all major course work must be completed at Cypress College.

Courses that fulfill major requirements for an Associate Degree at Cypress College might not be the same as those required for completing the major at a transfer institution offering a Baccalaureate Degree. For information on specific university requirements, please consult with your counselor, or visit the Transfer Center.

Required courses are listed in suggested sequence:

| Course # | Title | Units |
|-----------------------------|---------------------------------------|-----------|
| HRC 101 C | Introduction to Hospitality Careers | 3 |
| HRC 120 C | Sanitation and Safety | 3 |
| HRC 125 C | Restaurant Management | 3 |
| HRC 152 C | Hospitality Purchasing | 3 |
| HRC 160 C | Hotel Operations | 3 |
| HRC 164 C | Hospitality Law | 3 |
| HRC 170 C | Beverage Management | 3 |
| HRC 230 C | Hospitality Leadership | 3 |
| HRC 231 C | Cost Control in Hospitality | 3 |
| HRC 232 C | Special Event Management | 3 |
| HRC 290 C | Hospitality Career Capstone | 3 |
| ECON 105 C | Principles of Economics — Micro or | 3 |
| ECON 105HC | Honors Principles of Economics | 3 |
| Total Units Required | | 36 |

HOSPITALITY MANAGEMENT CERTIFICATE (formerly Hotel Operations Certificate)

Program Code: 1C21121

The Hotel Operations Certificate offers course work in rooms operations, revenue management, food and beverage management, special events, purchasing, law, cost control, human resources, and sales and marketing. Coursework emphasizes the role of guest services, effective oral and written communication skills, teamwork, management and leadership strategies, ethical decision-making and critical thinking. Students will prepare for careers in the dynamic hospitality industry.

To earn a certificate, students must complete the required courses as listed with a “C” or better. At least 50% of all course work must be completed at Cypress College.

Required courses are listed in suggested sequence:

| Course # | Title | Units |
|-----------------------------|-------------------------------------|-----------|
| HRC 101 C | Introduction to Hospitality Careers | 3 |
| HRC 120 C | Sanitation and Safety | 3 |
| HRC 125 C | Restaurant Management | 3 |
| HRC 152 C | Hospitality Purchasing | 3 |
| HRC 160 C | Hotel Operations | 3 |
| HRC 164 C | Hospitality Law | 3 |
| HRC 170 C | Beverage Management | 3 |
| HRC 230 C | Hospitality Leadership | 3 |
| HRC 231 C | Cost Control in Hospitality | 3 |
| HRC 232 C | Special Event Management | 3 |
| HRC 290 C | Hospitality Career Capstone | 3 |
| ECON 105 C | Principles of Economics — Micro | 3 |
| Total Units Required | | 36 |

RESTAURANT - LODGING ENTREPRENEUR CERTIFICATE **Program Code: 1C12985**

This certificate provides students with the necessary skills and knowledge to start, manage and promote their own restaurant, inn, or bed and breakfast establishment. Students who complete the program will learn about guest relations, customer service, basic management techniques, marketing and sales for their own small business.

To earn a certificate, students must complete the required courses as listed with a minimum grade of "C." At least 50% of all course work must be completed at Cypress College.

Required courses are listed in suggested sequence:

| Course # | Title | Units |
|-----------------------------|-------------------------------------|-----------|
| HRC 101 C | Introduction to Hospitality Careers | 3 |
| HRC 152 C | Hospitality Purchasing | 3 |
| HRC 160 C | Hotel Operations | 3 |
| MKT 222 C | Principles of Marketing | 3 |
| MGT 261 C | Small Business Management | 3 |
| Total Units Required | | 15 |

HOTEL FUNDAMENTALS CERTIFICATE **Program Code: 1C12980**

The Hotel Fundamentals Certificate provides students with an opportunity to obtain the foundational skills and practical knowledge for pursuing an entry-level career in hotel operations. Students completing this certificate will develop an understanding of hotel front office operations, revenue management, housekeeping, engineering, food and beverage, loss prevention, guest relations, and sales and marketing.

To earn a certificate, students must complete the required courses as listed with a minimum grade of "C." At least 50% of all course work must be completed at Cypress College.

Required courses are listed in suggested sequence:

| Course # | Title | Units |
|-----------------------------|-------------------------------------|-----------|
| HRC 101 C | Introduction to Hospitality Careers | 3 |
| HRC 160 C | Hotel Operations | 3 |
| HRC 164 C | Hospitality Law | 3 |
| HRC 230 C | Hospitality Leadership | 3 |
| HRC 231 C | Cost Control in Hospitality | 3 |
| Total Units Required | | 15 |

SPECIAL EVENT MANAGEMENT CERTIFICATE **Program Code: 1C17140**

The Special Event Management field is a large part of the local economy. Students will learn skills and knowledge necessary for success in the special event management field. This skill certificate provides students with entry-level skills and knowledge to transition into this rapidly growing field.

To earn a certificate, students must complete the required courses as listed with a minimum grade of "C." At least 50% of all course work must be completed at Cypress College.

Required courses are listed in suggested sequence:

| Course # | Title | Units |
|-----------------------------|-------------------------------------|-----------|
| HRC 101 C | Introduction to Hospitality Careers | 3 |
| HRC 125 C | Restaurant Management | 3 |
| HRC 232 C | Special Event Management | 3 |
| MKT 222 C | Principles of Marketing | 3 |
| MGT 261 C | Small Business Management | 3 |
| Total Units Required | | 15 |

HOSPITALITY, RESTAURANT, CULINARY ARTS TRANSFER PROGRAM

Students should consult a counselor or www.assist.org for lower division major requirements for most California public universities. (See the Standard Definitions section of the catalog for a description of ASSIST.) Students transferring to an independent college/university should consult the catalog of the individual school and a counselor for lower division major requirements.

Hotel, Restaurant, Culinary Arts (HRC)

HRC 100 C Nutrition 3 Units

Term hours: 54 lecture. Scientific concepts of nutrition related to the function of nutrients in basic life processes and current health issues with emphasis on individual needs. Course includes the role of carbohydrates, fats, protein, vitamins, water, minerals, alcohol and drugs in nutritional status. (UC/CSU, AA GE, CSU GE, C-ID: NUTR 110)

HRC 101 C Introduction to Hospitality Careers 3 Units

Prerequisite: Eligibility for ENGL 060 C or acceptable score on the placement test.

Term hours: 54 lecture. This course provides an overview of operations and career opportunities in the global hospitality management and culinary arts industry including lodging, restaurants, culinary arts, baking and pastry, beverage management, special events, managed services, cruise industry, gaming entertainment, and private clubs. Students will prepare a personalized career project. (CSU)

HRC 120 C Sanitation and Safety 3 Units

Prerequisite: Eligibility for ENGL 060 C or acceptable score on placement test.

Term hours: 54 lecture. This course will acquaint students with sanitation and safety principles and prepare students for the national food handler's certification examination. Course content includes strategies to identify and prevent foodborne illness, the flow of food through food service operations and sanitation management. (CSU)

HRC 125 C Restaurant Management 3 Units

Prerequisite: HRC 101 C and HRC 120 C with minimum grades of "C".

Term hours: 36 lecture and 72 laboratory. Students will experience restaurant operations and management through theoretical studies and hands on practice. Topics include role of service in restaurant operations, hiring, training, teamwork, cost control, revenue management and the leadership skills required to effectively manage restaurant operations. \$50.00 Materials fee - Payable at Registration. (CSU)

HRC 135 C Culinary Fundamentals I 3 Units

Prerequisite: Completion of or concurrent enrollment in HRC 120 C.

Term hours: 36 lecture and 72 laboratory. Great cuisine rests on the mastery of seemingly simple preparations and techniques that determine the quality of the final product. This course will focus on the basic principles, skills, and techniques associated with culinary arts, involving various cooking methods including classic and modern techniques. Students will identify various kitchen items to include; food products and equipment used within the commercial food operation. \$95.00 Material Fee-Payable at Registration. (CSU)

HRC 136 C Baking Fundamentals I 3 Units

Prerequisite: Completion of or concurrent enrollment in HRC 120 C with a minimum grade of "C".

Term hours: 36 lecture and 72 laboratory. Well-executed desserts rely on a mastery of fundamental techniques. This course will focus on the history of baking, terminology, ingredients, equipment, storage and sanitation in the bakeshop. Students will gain experience in using various mixing, holding and baking methods as well as international techniques to create an assortment of yeast dough, quick breads, cookies, pies, tarts and cakes. \$95.00 Material Fee-Payable at Registration. (CSU)

HRC 145 C The Art of Garde Manger 3 Units

Prerequisite: HRC 120 C and HRC 135 C with minimum grades of "C".

Term hours: 36 lecture and 72 laboratory. Hors d'oeuvres and appetizers challenge the chef to create masterpieces in miniature. This course will focus on the discussion and application of the art of Garde Manger to include hot and cold hors d'oeuvres (canapes, finger sandwiches and savories); cold set mousses; the principles and applications necessary for sausage making; concepts and application of salt curing of meats and fish items and principles of smoking. \$120.00 Material Fee - Payable at Registration. (CSU)

HRC 152 C Hospitality Purchasing 3 Units

Prerequisite: Completion of or concurrent enrollment in HRC 101 C with a minimum grade of "C".

Term hours: 54 lecture. This course examines the principles and procedures of hospitality procurement, purchasing merchandise, receiving, inventory control techniques and menu analysis. The students will focus on managing strategies for optimal performance in procurement and purchasing resulting in profitable hospitality operations. (CSU)

HRC 160 C Hotel Operations 3 Units

Prerequisite: Completion of or enrollment in HRC 101 C with a minimum grade of "C".

Term hours: 54 lecture. An overview of careers, operating systems and practices of a hotel facility, which includes: front office, housekeeping, property maintenance, food and beverage, human resources management, information systems and sales and marketing. (CSU)

HRC 164 C Hospitality Law 3 Units

Prerequisite: Completion of or concurrent enrollment in HRC 101 C with a minimum grade of "C".

Term hours: 54 lecture. This course presents legal aspects of managing hospitality operations with an emphasis on compliance best practices and prevention of liabilities. Topics include serving food safely, responsible alcohol service, selecting and managing employees, regulatory concerns, property management, hospitality operating structures, common contracts, safety and security, and crisis management. (CSU)

HRC 170 C Beverage Management 3 Units

Prerequisite: HRC 152 C with a minimum grade of "C".

Term hours: 54 lecture. This course is designed for students who intend to pursue a career in food and beverage management. Topics include current wine, beer and spirit beverage trends, risk-liability management, purchasing, storage, loss prevention, responsible alcohol service, beverage pricing, and food pairing. (CSU)

HRC 230 C Hospitality Leadership 3 Units

Prerequisite: HRC 101 C with a minimum grade of "C".

Advisory: HRC 160 C.

Term hours: 54 lecture. This course explores hospitality management and leadership strategies. Case study analysis will focus on management and leadership principles, role of diversity, reputation management and ethical considerations in the hospitality industry. (CSU)

HRC 231 C Cost Control in Hospitality 3 Units

Advisory: HRC 152 C.

Term hours: 54 lecture. This course examines the principles of cost control and revenue management. The students will identify, analyze, and solve problems in order to keep costs low and profit margins high in the hospitality industry. Areas covered in course include: management of revenue and expenses, cost of goods, volume management, profit relationships, forecasting, use of technology to enhance controls, financial analysis, and labor control. (CSU)

HRC 232 C Special Event Management 3 Units

Prerequisite: HRC 101 C.

Term hours: 54 lecture. The course is a comprehensive study of the field of special events with emphasis on creating and executing catered events. Topics include: special event venues, event organization and management, skills and abilities for event managers. (CSU)

HRC 235 C Culinary Fundamentals II 3 Units

Prerequisite: HRC 120 C and HRC 135 C with minimum grades of "C".

Term hours: 36 lecture and 72 laboratory. Great chefs rest on mastering the advance techniques utilized in today's commercial kitchens. The most crucial is flavor development, which students begin to learn at the start of their studies. This course will focus on the principles, skills, and techniques associated with advanced culinary arts, involving fabrication and identification of common proteins utilized in commercial operations. \$120.00 Material Fee - Payable at Registration. (CSU)

HRC 236 C Baking Fundamentals II 3 Units

Prerequisite: HRC 136 C with a minimum grade of "C" and completion of or concurrent enrollment in HRC 120 C.

Term hours: 36 lecture and 72 laboratory. Creating classic cakes and tortes, artisan breads and frozen desserts calls for creativity and technical understanding. This course focuses on advanced pastries and bread production. Products include classical cakes and tortes, frozen desserts, artisan breads and Viennoiserie. Emphasis will be placed on commercial production of high quality products and professional presentation. \$95.00 Material fee - Payable at Registration. (CSU)

HRC 246 C Pastry Arts 3 Units

Prerequisite: HRC 236 C with a minimum grade of "C".

Term hours: 36 lecture and 72 laboratory. Candy making, cake decorating, and dessert plating represent the ultimate fusion of art and craft. This course focuses on pastry arts to include restaurant style desserts, confections, special occasion cakes and pastry showpieces. Emphasis will be placed on commercial production of high quality products and professional presentation. \$120.00 Material Fee - Payable at Registration. (CSU)

HRC 255 C American Regional Cuisine 3 Units

Prerequisite: HRC 120 C and HRC 235 C or HRC 236 C with minimum grades of "C".

Term hours: 36 lecture and 72 laboratory. This culinary tour of America includes product identification, correct utilization and cooking methods. This course focuses on a regional perspective of American cuisine. Students will have the opportunity to produce regional specialties while researching the influence of culture on the development of American cuisine. \$95.00 Material Fee - Payable at Registration. (CSU)

HRC 265 C International Cuisine 3 Units

Prerequisite: HRC 120 C and HRC 235 C or HRC 236 C with minimum grades of "C".

Term hours: 36 lecture and 72 laboratory. This culinary tour of the world includes product identification, correct utilization and cooking methods. This course focuses on a global perspective of various regional cuisines. Students will have the opportunity to produce ethnic foods while researching the influence of culture on the development of international cuisines. \$75.00 Material Fee - Payable at Registration. (CSU)

HRC 290 C Hospitality Career Capstone 3 Units

Prerequisite: HRC 101 C with a minimum grade of "C".

Advisory: HRC 290 C (Hospitality Career Capstone) requires 100 hours of hospitality industry related work experience and is recommended for HRC majors in their final year of study.

Term hours: 54 lecture. This course prepares students for careers and upward mobility in the hospitality industry. Students will develop industry expected employability skills to include professionalism, business communication, and technological aptitude. Successful employment in the hospitality industry through targeted resumes and effective interviewing will be covered. Students will synthesize related industry experience through the creation of personalized career portfolio. (CSU)

Human Services

Division of Social Sciences

Division Dean — Lisa Gaetje, Interim

Faculty

Virgil Adams, III
James Tapia
Gary Zager

Counselors

Therese Mosqueda-Ponce
Daniel Pelletier

PROGRAM LEARNING OUTCOMES (PLOs)

The courses taught by this department contribute to the General Education and Basic Skills Program Learning Outcomes. Please refer to General Education and Basic Skills Program Learning Outcomes.

ASSOCIATE IN ARTS DEGREE HUMAN SERVICES Program Code: 1A03803

The Human Services Program for the Associate in Arts Degree prepares students for a variety of careers in public and private social service agencies. Course work includes completion of 30 units plus 6 elective units in one or more specialty areas of Addiction Studies, Conflict Resolution, Criminal Justice, Family Studies, Gerontology, Human Services Generalist, and Victimology.

To earn an Associate Degree students must complete: (1) all major course requirements with a minimum grade of "C"; (2) 25 units of General Education Graduation Requirements; (3) any elective courses to complete a minimum of 60 units; and, (4) with an overall GPA of 2.0. At least 50% of all major course work must be completed at Cypress College.

Courses that fulfill major requirements for an Associate Degree at Cypress College might not be the same as those required for completing the major at a transfer institution offering a Baccalaureate Degree. For information on specific university requirements, please consult with your counselor, or visit the Transfer Center.

Required courses are listed in suggested sequence:

| Course # | Title | Units |
|---|----------------------------------|-------|
| Required core courses (30 units) are listed. It is recommended that all fieldwork courses (HUSR 210 C or HUSR 211 C) be taken only after consultation with an Academic Counselor, Department Chair or the course Instructor. | | |
| HUSR 200 C | Introduction to Human Services | 3 |
| HUSR 210 C | Introductory Fieldwork | 3 |
| HUSR 211 C | Advanced Fieldwork | 3 |
| HUSR 222 C | Group Leadership/Group Process | 3 |
| HUSR 224 C | Self-Esteem Strategies | 3 |
| HUSR 240 C | Drugs and Alcohol in Our Society | 3 |
| HUSR 241 C | Intervention Strategies | 3 |
| HUSR 275 C | Ethical Issues in Human Services | 3 |
| PSY 139 C | Developmental Psychology | 3 |
| COMM 120 C | Intercultural Communication | 3 |

Electives (Select 6 units from below)

| | | Units |
|------------|----------------------------------|-------|
| HUSR 215 C | Introduction to Family Studies | 3 |
| HUSR 221 C | Crisis Intervention and Referral | 3 |
| HUSR 223 C | Helping Skills — Human Services | 3 |
| HUSR 225 C | Families and Substance Abuse | 3 |
| HUSR 226 C | Behavior Modification | 3 |
| HUSR 242 C | Drugs and Physiology | 3 |
| HUSR 243 C | Co-Occurring Disorders | 3 |
| SOC 250 C | Sociology of Aging | 3 |
| | or | |
| HUSR 250 C | Sociology of Aging | (3) |
| HUSR 255 C | Psychology of Aging | 3 |
| | or | |
| PSY 255 C | Psychology of Aging | (3) |
| HUSR 270 C | Introduction to Victimology | 3 |
| HUSR 271 C | Society and Victimization | 3 |
| HUSR 281 C | Prevention Strategies | 3 |
| HUSR 291 C | Counseling in Criminal Justice | 3 |
| HUSR 292 C | Introduction to Criminology | 3 |
| | or | |
| SOC 292 C | Introduction to Criminology | (3) |
| HUSR 293 C | Conflict Resolution/Mediation | 3 |
| HUSR 294 C | Careers in Criminal Justice | 3 |
| HUSR 295 C | Cross-Cultural Criminology | 3 |
| PSY 131 C | Cross-Cultural Psychology | 3 |
| ETHS 101 C | American Ethnic Studies | 3 |
| | or | |
| ETHS 101HC | Honors American Ethnic Studies | (3) |

Total Units Required 36

HUMAN SERVICES CERTIFICATE PROGRAMS

The Human Services Department includes certificate programs in Addiction Studies, Conflict Resolution, Criminal Justice, Family Studies, Gerontology, Human Services Generalist, and Victimology. Each specialization recommends a core of required courses including fieldwork experience, and 6 to 12 units of specialization courses. The curricula are designed so that students with interests in several areas can complete more than one certificate program in an effective and efficient manner. The California Association of Alcohol/Drug Educators approves the Addiction Studies Certificate program. The Conflict Resolution Certificate prepares students to assist in the resolution of conflict in various settings including home and work with an emphasis on human relations in business, management positions in treatment facilities, and issues in victimology and cross-cultural conflict. The Criminal Justice Certificate will prepare students to work with Human Services agencies that provide services to clients coming from the criminal justice system. The Family Studies Certificate offers the student the opportunity to examine today's changing family needs, values and patterns as well as to form the foundation for a career in family studies professions. The Gerontology Certificate explores appropriate human service agencies, intervention strategies, and the adaptive and maladaptive behaviors of the normal aging process for the individual and their family. The Victimology Certificate examines the network of agencies available for victims and perpetrators as well as the variety of methods for dealing with this issue. The Human Services Generalist Certificate has training applicable in all Human Services areas.

ADDICTION STUDIES CERTIFICATE

Program Code: 1C07845

This certificate will prepare students to work with Human Services Agencies that provide services to clients in the area of substance abuse issues regarding issues from abuse to addiction. Students will examine the requirements, major tasks and responsibilities, including the role and function of halfway homes, substance abuse recovery centers and sober living sites in the State of California.

To earn a certificate, students must complete the required courses as listed with a minimum grade of "C." At least 50% of all course work must be completed at Cypress College.

Required courses are listed in suggested sequence:

| Course # | Title | Units |
|---|----------------------------------|-------|
| Required core (27 units) courses are listed. It is recommended that all fieldwork courses (HUSR 210 C or HUSR 211 C) be taken only after consultation with an Academic Counselor, Department Chair or the course Instructor. | | |
| PSY 139 C | Developmental Psychology | 3 |
| HUSR 200 C | Introduction to Human Services | 3 |
| HUSR 210 C | Introductory Fieldwork | 3 |
| HUSR 211 C | Advanced Fieldwork | 3 |
| HUSR 225 C | Families and Substance Abuse | 3 |
| HUSR 240 C | Drugs and Alcohol in Our Society | 3 |
| HUSR 241 C | Intervention Strategies | 3 |
| HUSR 242 C | Drugs and Physiology | 3 |
| HUSR 275 C | Ethical Issues in Human Services | 3 |

Select a minimum of (9) units from the elective courses listed below:

| | Units | |
|-----------------------------|------------------------------------|-----------|
| HUSR 221 C | Crisis Intervention and Referral | 3 |
| HUSR 222 C | Group Leadership/Group Process | 3 |
| HUSR 223 C | Helping Skills — Human Services | 3 |
| HUSR 224 C | Self-Esteem Strategies | 3 |
| HUSR 226 C | Behavior Modification | 3 |
| HUSR 243 C | Co-Occurring Disorders | 3 |
| HUSR 270 C | Introduction to Victimology | 3 |
| HUSR 281 C | Prevention Strategies | 3 |
| HUSR 290 C | Human Services in Criminal Justice | 3 |
| HUSR 291 C | Counseling in Criminal Justice | 3 |
| PSY 131 C | Cross-Cultural Psychology | 3 |
| ETHS 101 C | American Ethnic Studies | 3 |
| | or | |
| ETHS 101HC | Honors American Ethnic Studies | (3) |
| Total Units Required | | 36 |

CONFLICT RESOLUTION CERTIFICATE

Program Code: 1C17141

This program offers those entering or working in human services the opportunity to examine and practice a variety of communication skills useful in the resolution of conflict.

To earn a certificate, students must complete the required courses as listed with a minimum grade of "C." At least 50% of all course work must be completed at Cypress College.

Required core courses (12 Units) are listed in suggested sequence:

| Course # | Title | Units |
|------------|----------------------------------|-------|
| HUSR 293 C | Conflict Resolution/Mediation | 3 |
| HUSR 275 C | Ethical Issues in Human Services | 3 |
| MGT 266 C | Human Relations in Business | 3 |
| HUSR 210 C | Introductory Fieldwork | 3 |

Select a minimum of (3) units from the elective courses listed below:

| | Units | |
|-----------------------------|----------------------------------|-----------|
| COMM 105 C | Interpersonal Communication | 3 |
| HUSR 221 C | Crisis Intervention and Referral | 3 |
| HUSR 222 C | Group Leadership/Group Process | 3 |
| HUSR 224 C | Self-Esteem Strategies | 3 |
| HUSR 270 C | Introduction to Victimology | 3 |
| HUSR 295 C | Cross-Cultural Criminology | 3 |
| PSY 131 C | Cross-Cultural Psychology | 3 |
| Total Units Required | | 15 |

CRIMINAL JUSTICE CERTIFICATE

Program Code: 1C12113

This certificate program will prepare students to work with Human Services agencies that provide services to clients coming from the criminal justice system. Students will examine the skill requirements, the major tasks and responsibilities, the role and function of the service provider in jails, penal institutions, police departments, juvenile justice agencies and the Department of Corrections.

To earn a certificate, students must complete the required courses as listed with a minimum grade of "C." At least 50% of all course work must be completed at Cypress College.

Required courses are listed in suggested sequence:

| Course # | Title | Units |
|------------|------------------------------------|-------|
| HUSR 210 C | Introductory Fieldwork | 3 |
| HUSR 211 C | Advanced Fieldwork | 3 |
| HUSR 223 C | Helping Skills — Human Services | 3 |
| HUSR 224 C | Self-Esteem Strategies | 3 |
| HUSR 275 C | Ethical Issues in Human Services | 3 |
| HUSR 290 C | Human Services in Criminal Justice | 3 |
| HUSR 291 C | Counseling in Criminal Justice | 3 |
| SOC 292 C | Introduction to Criminology | 3 |
| | or | |
| HUSR 292 C | Introduction to Criminology | (3) |
| HUSR 294 C | Careers in Criminal Justice | 3 |
| HUSR 295 C | Cross-Cultural Criminology | 3 |

Select a minimum of 9 units from the elective courses below:

| Course # | Title | Units |
|-----------------------------|----------------------------------|-----------|
| HUSR 221 C | Crisis Intervention and Referral | 3 |
| HUSR 225 C | Families and Substance Abuse | 3 |
| HUSR 240 C | Drugs and Alcohol in Our Society | 3 |
| HUSR 241 C | Intervention Strategies | 3 |
| HUSR 242 C | Drugs and Physiology | 3 |
| HUSR 243 C | Co-Occurring Disorders | 3 |
| HUSR 270 C | Introduction to Victimology | 3 |
| HUSR 271 C | Society and Victimization | 3 |
| HUSR 293 C | Conflict Resolution/Mediation | 3 |
| Total Units Required | | 39 |

FAMILY STUDIES CERTIFICATE

Program Code: 1C10452

The Family Studies Certificate Program in Human Services is designed as a more complete examination of the many individual and family needs resulting from changing family patterns. Needed skills include parenting in a variety of family situations, communicating in healthy relationships, caregiving in intergenerational families and coping with stress. This program prepares the student in three ways: (1) Providing courses as personal enrichment for the families and individuals in the community; (2) Training Human Services workers for employment in schools, health and mental health agencies, rehabilitation centers, halfway houses, senior centers and as support persons to law enforcement and other community agencies; and (3) Providing the first two years of courses for Family Studies professions such as therapist and administrator which require further college education.

To earn a certificate, students must complete the required courses as listed with a minimum grade of "C." At least 50% of all course work must be completed at Cypress College.

Required courses are listed. It is recommended that all fieldwork courses (HUSR 210 C or HUSR 211 C) be taken only after consultation with an Academic Counselor, Department Chair or the course Instructor.

| Course # | Title | Units |
|------------|----------------------------------|-------|
| HUSR 200 C | Introduction to Human Services | 3 |
| HUSR 210 C | Introductory Fieldwork | 3 |
| HUSR 215 C | Introduction to Family Studies | 3 |
| HUSR 224 C | Self-Esteem Strategies | 3 |
| PSY 139 C | Developmental Psychology | 3 |
| HUSR 270 C | Introduction to Victimology | 3 |
| HUSR 275 C | Ethical Issues in Human Services | 3 |
| SOC 275 C | Marriage and Family | 3 |

Select a minimum of (6 units) from the electives listed below:

| Course # | Title | Units |
|-----------------------------|----------------------------------|-----------|
| PSY 120 C | Human Sexuality | 3 |
| HUSR 221 C | Crisis Intervention and Referral | 3 |
| HUSR 222 C | Group Leadership/Group Process | 3 |
| HUSR 223 C | Helping Skills — Human Services | 3 |
| HUSR 225 C | Families and Substance Abuse | 3 |
| HUSR 226 C | Behavior Modification | 3 |
| HUSR 240 C | Drugs and Alcohol in Our Society | 3 |
| HUSR 250 C | Sociology of Aging | 3 |
| | or | |
| SOC 250 C | Sociology of Aging | (3) |
| PSY 255 C | Psychology of Aging | 3 |
| | or | |
| HUSR 255 C | Psychology of Aging | (3) |
| HUSR 295 C | Cross-Cultural Criminology | 3 |
| PSY 131 C | Cross-Cultural Psychology | 3 |
| ETHS 101 C | American Ethnic Studies | 3 |
| | or | |
| ETHS 101HC | Honors American Ethnic Studies | (3) |
| Total Units Required | | 30 |

GERONTOLOGY CERTIFICATE

Program Code: 1C07842

The Gerontology Certificate Program in Human Services is a collection of interdisciplinary courses that prepare students to bring expertise, intervention skills and understanding about the aging adult to work and to family settings. Older adult development, and adaptive and maladaptive behaviors of the normal aging process are explored. Emphasis will be placed on critical life issues such as health, mental health, care giving, social support, living arrangements, work and retirement, and human service resources. Death and dying, and the ethical issues that often occur during the last years of life will be examined.

To earn a certificate, students must complete the required courses as listed with a minimum grade of "C." At least 50% of all course work must be completed at Cypress College.

Required core (12 units) courses are listed in suggested sequence:

| Course # | Title | Units |
|------------|----------------------------------|-------|
| HUSR 200 C | Introduction to Human Services | 3 |
| HUSR 275 C | Ethical Issues in Human Services | 3 |
| HUSR 210 C | Introductory Fieldwork | 3 |
| SOC 250 C | Sociology of Aging | 3 |
| | or | |
| HUSR 250 C | Sociology of Aging | (3) |

Select 3 units from the elective courses listed below.

| Course # | Title | Units |
|-----------------------------|----------------------------------|-----------|
| PSY 255 C | Psychology of Aging | 3 |
| | or | |
| HUSR 255 C | Psychology of Aging | (3) |
| HUSR 215 C | Introduction to Family Studies | 3 |
| HUSR 221 C | Crisis Intervention and Referral | 3 |
| PSY 120 C | Human Sexuality | 3 |
| PE 235 C | First Aid, CPR and Emergencies | 3 |
| Total Units Required | | 15 |

HUMAN SERVICES GENERALIST CERTIFICATE

Program Code: 1C21122

To earn a certificate, students must complete the required courses as listed with a minimum grade of "C." At least 50% of all course work must be completed at Cypress College.

Required core (27 units) courses are listed in suggested sequence:

| Course # | Title | Units |
|------------|----------------------------------|-------|
| HUSR 200 C | Introduction to Human Services | 3 |
| HUSR 275 C | Ethical Issues in Human Services | 3 |
| HUSR 222 C | Group Leadership/Group Process | 3 |
| PSY 139 C | Developmental Psychology | 3 |
| HUSR 224 C | Self-Esteem Strategies | 3 |
| HUSR 210 C | Introductory Fieldwork | 3 |
| HUSR 225 C | Families and Substance Abuse | 3 |
| HUSR 241 C | Intervention Strategies | 3 |
| HUSR 211 C | Advanced Fieldwork | 3 |

Select a minimum of (9 units) from the required electives listed below:

| | Units |
|------------|------------------------------------|
| PSY 120 C | Human Sexuality 3 |
| HUSR 215 C | Introduction to Family Studies 3 |
| HUSR 221 C | Crisis Intervention and Referral 3 |
| HUSR 223 C | Helping Skills — Human Services 3 |
| HUSR 226 C | Behavior Modification 3 |
| HUSR 240 C | Drugs and Alcohol in Our Society 3 |
| HUSR 242 C | Drugs and Physiology 3 |
| HUSR 243 C | Co-Occurring Disorders 3 |
| HUSR 250 C | Sociology of Aging 3 |
| | or |
| SOC 250 C | Sociology of Aging (3) |
| HUSR 255 C | Psychology of Aging 3 |
| | or |
| PSY 255 C | Psychology of Aging (3) |
| HUSR 270 C | Introduction to Victimology 3 |
| HUSR 271 C | Society and Victimization 3 |
| HUSR 281 C | Prevention Strategies 3 |
| HUSR 291 C | Counseling in Criminal Justice 3 |
| HUSR 292 C | Introduction to Criminology 3 |
| | or |
| SOC 292 C | Introduction to Criminology (3) |
| HUSR 294 C | Careers in Criminal Justice 3 |
| HUSR 295 C | Cross-Cultural Criminology 3 |
| PSY 131 C | Cross-Cultural Psychology 3 |
| ETHS 101 C | American Ethnic Studies 3 |
| | or |
| ETHS 101HC | Honors American Ethnic Studies (3) |
| | Total Units Required 36 |

VICTIMOLOGY CERTIFICATE

Program Code: 1C07847

The study of Victimology explores the costs of victimization in our society today and the variety of methods, current and proposed, for dealing with the issues. Courses provide an in-depth examination of both the victim and the perpetrator. Resources for victims of violent and non-violent crimes are discussed and professionals present various points of view.

To earn a certificate, students must complete the required courses as listed with a minimum grade of "C." At least 50% of all course work must be completed at Cypress College.

Required courses are listed in suggested sequence:

| Course # | Title | Units |
|------------|------------------------------------|-------|
| HUSR 200 C | Introduction to Human Services | 3 |
| HUSR 275 C | Ethical Issues in Human Services | 3 |
| HUSR 223 C | Helping Skills — Human Services | 3 |
| HUSR 270 C | Introduction to Victimology | 3 |
| HUSR 271 C | Society and Victimization | 3 |
| HUSR 290 C | Human Services in Criminal Justice | 3 |
| HUSR 210 C | Introductory Fieldwork | 3 |
| HUSR 211 C | Advanced Fieldwork | 3 |

Electives (Select 6 units from below.)

| | Units |
|------------|------------------------------------|
| PSY 139 C | Developmental Psychology 3 |
| HUSR 221 C | Crisis Intervention and Referral 3 |
| HUSR 222 C | Group Leadership/Group Process 3 |
| HUSR 224 C | Self-Esteem Strategies 3 |
| HUSR 225 C | Families and Substance Abuse 3 |
| HUSR 226 C | Behavior Modification 3 |
| HUSR 228 C | Group Process and Practice 3 |
| HUSR 240 C | Drugs and Alcohol in Our Society 3 |
| HUSR 295 C | Cross-Cultural Criminology 3 |
| | Total Units Required 30 |

OFF-CAMPUS PROGRAMS

Cypress' Human Services Department provides flexible, off-campus courses and workshops to further meet the education and training needs of human services. Specially designed training is available to meet the needs of community leaders, professionals, paraprofessionals, volunteers, community groups and organizations. For further information, contact the Human Services Department.

TRANSFER PROGRAM — HUMAN SERVICES

The student in human services has the option of completing an Associate in Arts degree with a major in Human Services by completing the general education requirements in addition to the Certificate Program. The program is also designed for students who plan to continue with professional preparation at the university level in social work, human services, criminal justice, gerontology, counseling, and related social service fields.

Students should consult a counselor or www.assist.org for lower division major requirements for most California public universities. (See the Standard Definitions section of the catalog for a description of ASSIST.) Students transferring to an independent college/university should consult the catalog of the individual school and a counselor for lower division major requirements.

Human Services (HUSR)

HUSR 084 C Introduction to Behavior Modification .5 Units

Term hours: 9 lecture. This course is for individuals working in programs for developmentally disabled persons, as well as those interested in the field. It will cover basic information about behaviorally oriented work with such clients, including content on behavior modification, teaching methods and ways to encourage clients.

HUSR 200 C Introduction to Human Services 3 Units

Term hours: 54 lecture. This course covers the history and philosophy of the human services; function and orientation of human services agencies and institutions; human services as careers; opportunities and qualifications at various entry levels of human services employment. (CSU, CSU GE)

HUSR 210 C Introductory Fieldwork 3 Units

Prerequisite: HUSR 200 C with a minimum grade of "C".

Term hours: 18 lecture and 125 laboratory. This course offers observation and participation in the operations of human services agencies. The student will document 125 hours of supervised field study per semester and will attend one hour lecture per week. Pass/No Pass/Letter Grade Option. (CSU)

HUSR 211 C Advanced Fieldwork 3 Units

Prerequisite: HUSR 210 C.

Term hours: 18 lecture and 126 laboratory. This course is the second of a two-semester sequence of volunteer or paid fieldwork experience. The student will apply values, concepts and skills of core human services courses to the actual process of helping people. Emphasis of this semester is on sharpening skills and knowledge gained in the introductory field experience. There is one hour of classroom experience per week. Pass/No Pass/Letter Grade Option. (CSU)

HUSR 215 C Introduction to Family Studies 3 Units

Term hours: 54 lecture. This course involves intergenerational family studies and related career exploration to introduce Human Services students to family issues and to skills, theories, and competencies needed to empower families for reaching their goals. Various family issues, family/worker relationships, strength-based assessments, resource referral/utilization, community service coordination, and family and worker stress management are covered. (CSU)

HUSR 221 C Crisis Intervention and Referral 3 Units

Term hours: 54 lecture. This course introduces techniques for beginning crisis counseling, including recognition of crisis, assessment of crisis, and referral to the appropriate crisis agency. Special attention will be given to the process of intervention and to the recording of information regarding problems with alcohol and other drugs. Participants will implement a variety of crisis skills through an experiential format. (CSU)

HUSR 222 C Group Leadership-Group Process 3 Units

Term hours: 54 lecture. This course examines membership and leadership in a variety of groups, with emphasis on the total group process. An overview of the various types of groups will be given as well as the values and limitations of groups, cautions and risks of groups and common misconceptions about groups. The student will be offered experience as a group member and a group leader. (CSU)

HUSR 223 C Helping Skills-Human Services 3 Units

Term hours: 54 lecture. This course involves identification and application of specific helping skills in intrapersonal and interpersonal relations. It is designed for persons in helping roles, professional and paraprofessional, or volunteers in Human Services. (CSU)

HUSR 224 C Self-Esteem Strategies 3 Units

Term hours: 54 lecture. This course is designed for those considering a career in management and staff development in Human Services Agencies, with special application to client after-care programs. Theory and technique are combined in this skills class to assist case managers and program directors with assessment and evaluation, individual recovery program development, educational process and materials, and utilization of resources and referral procedures. This course focuses on issues of self-esteem, concept formation, problem solving, time management, emotional intelligence, and decision making for client and/or staff development. (CSU)

HUSR 225 C Families and Substance Abuse 3 Units

Term hours: 54 lecture. This course presents the dynamics of the family system as they are affected by addiction. Theories of healthy and unhealthy family interaction are explored and the experiential format provides the opportunity for skill development and practical experience. (CSU)

HUSR 226 C Behavior Modification 3 Units

Term hours: 54 lecture. This course includes both theory and practice in behavior modification principles. It teaches skills such as observing and recording behavior, uses of reinforcement, extinction, punishment, etc. Self-management techniques to assist in control of one's own behavior will also be discussed. Topics have wide application in any course of study and will require dealing effectively with others, or with more effective management of oneself. (CSU)

HUSR 240 C Drugs and Alcohol in Our Society 3 Units

Term hours: 54 lecture. This is an introductory course for individuals in any area of human services who desire to increase their knowledge regarding problems resulting from drug and/or alcohol abuse and addiction. This course will cover the basic casual theories of alcoholism, identification of signs and symptoms, dispel "myths" and provide information on past and current treatment modalities. Students will be introduced to the history of drug use in general; their misuse and abuse, including societal methods implemented for their regulation and control. (CSU)

HUSR 241 C Intervention Strategies 3 Units

Term hours: 54 lecture. This course will serve as an assessment and treatment approach to individuals having problems with alcohol and other drugs. Alcoholism will be studied in its social and clinical context. Attention will be given to basic theoretical approaches to the disease. Major emphasis will be on the philosophical and clinical approaches to treating the alcoholic and to promoting recovery. (CSU)

HUSR 242 C Drugs and Physiology 3 Units

Term hours: 54 lecture. This course explores the effects of alcohol and other drugs on the body. It examines the physiology of alcohol in two areas: (1) physical effects of alcohol on the body, and (2) the physiological effects of the disease processes associated with heavy drinking. (CSU)

HUSR 243 C Co-Occurring Disorders 3 Units

Term hours: 54 lecture. This course will introduce the student to the treatment needs of those who have a psychiatric disorder in combination with a chemical dependency disorder. Students learn to identify and assess those with a dual diagnostic/co-occurring disorder. Pass/No Pass/Letter Grade Option. (CSU)

HUSR 250 C Sociology of Aging 3 Units

Same as SOC 250 C

Term hours: 54 lecture. This course explores the concept of aging and sociological/cultural theories of aging. The gender, cross-cultural, economic, political and social policy aspects of aging in society and the world are examined. Critical life issues for elders and for those who live and work with them are explored. These issues include empowerment, care giving, social support, living arrangements, elder abuse, work, retirement, quality of life and death and dying. Duplicate credit not granted for SOC 250 C. (UC/CSU, AA GE, CSU GE, IGETC)

HUSR 255 C Psychology of Aging 3 Units

Same as PSY 255 C

Term hours: 54 lecture. This course examines the biological, physiological, cognitive, personality, developmental, intimacy and sexual aspects of the ongoing aging process. Critical life issues for elders and for those who live and work with them are explored. These issues include physical health, mental health, health care policy, caregiving, dependency, and positive aging strategies. Duplicate credit not granted for PSY 255 C. (UC/CSU, AA GE, CSU GE, IGETC)

HUSR 270 C Introduction to Victimology 3 Units

Term hours: 54 lecture. This course responds to the emerging social concern regarding the cost of victimization to our society today. It provides education, information on existing resources, and direct participation in the creation and expansion of existing resources of treatment and recovery of victims and perpetrators. (CSU)

HUSR 271 C Society and Victimization 3 Units

Term hours: 54 lecture. This course will provide an understanding of the social problems of victimization with in-depth focus on both perpetrator and victim. Specific issues will be explored including their genesis and specific methods of identifying issues regarding self-help and support activities from a clinical approach. (CSU)

HUSR 275 C Ethical Issues in Human Services 3 Units

Term hours: 54 lecture. This course presents the rules and standards governing the professional conduct of those working in Human Services Agencies. Issues of client/patient rights, confidentiality, physical and emotional abuse, and counselor/client relationships will be explored in great depth. (CSU)

HUSR 281 C Prevention Strategies 3 Units

Term hours: 54 lecture. This course will present the history, theories and current strategies for prevention of alcohol and drug problems and for reduction of harm caused by those with problems (harm reduction). Conceptual frameworks, major research, epidemiology, environmental risk factors and the effectiveness of various prevention strategies will be examined. (CSU)

HUSR 290 C Human Services in Criminal Justice 3 Units

Term hours: 54 lecture. This experiential course will survey the historical, and philosophical aspects of criminal behavior and the functions and objectives of parole and probation. Students will examine the skill requirements, the major tasks and responsibilities, the role and function and the overall mission of the service provider in the criminal justice system. The judicial system and its relationship to the criminal offender will be examined as well as modern approaches in the control of crime. Resources for resocializing the offender will be explored. (CSU)

HUSR 291 C Counseling in Criminal Justice 3 Units

Term hours: 54 lecture. This course explores current theory and practice in the counseling of those in state prison treatment programs. Topics include an overview of the California Department of Corrections, the inmate classification system, specialized inmate management topics, violence and violence management strategies, victim awareness issues, the processes of addiction and recovery, an overview of assessment instruments, an exploration of sociopathy, and group counseling dynamics. (CSU)

HUSR 292 C Introduction to Criminology 3 Units

Same as SOC 292 C

Term hours: 54 lecture. This course presents a scientific analysis of the nature, extent, and causes of violations of societal rules of behavior that are formally defined as crime and delinquency. The course includes an analysis of the theoretical perspectives that led to the development of criminal law and the administration of criminal justice, the patterns of criminality and delinquency, the impact of crime on social change, and the labeling, identification, characteristics, and the treatment of criminals and delinquents. Duplicate credit not granted for SOC 292 C. (UC/CSU, CSU GE, IGETC, C-ID: SOCI 160)

HUSR 293 C Conflict Resolution-Mediation 3 Units

Course hours 54 lecture. This course examines the background, development and methodology of non-violent, non-litigious conflict resolution with emphasis on theory and the practice of mediation. This is a state certified course designed to train individuals to be effective in resolving conflict in the family, the community, the classroom and the workplace. Pass/No Pass/Letter Grade Option. (CSU)

HUSR 294 C Careers in Criminal Justice 3 Units

Term hours: 54 lecture. This course will provide the student with the opportunity to explore, in-depth, the breadth and scope of career opportunities in the field of criminal justice. Specific careers will be explored through guest speakers, field trips, on-site observations and mentoring opportunities. Students will gather knowledge and gain an appreciation for the criminal justice field as a result of this course. Pass/No Pass/Letter Grade Option. (CSU)

HUSR 295 C Cross-Cultural Criminology 3 Units

Term hours: 54 lecture. This course will explore cross-cultural customs and traditions from a criminal justice perspective. Specific cultures that are represented in significant numbers within the United States will be explored. Students will gather knowledge and gain an appreciation for the cross-cultural aspects within the field of criminal justice. Pass/No Pass/Letter Grade Option. (CSU, CUL DIV)

HUSR 298 C Human Services Seminar .5 to 3 Units

Prerequisite: May be required.

Corequisite: May be required.

Advisory: May be required.

Term hours: 0-216 lecture and/or 0-756 laboratory depending on units attempted. This is a lecture/discussion type course dealing with a particular limited problem or topic of interest to students. It is designed for students who wish to increase their knowledge of a particular topic that is offered in no other regular class. A paper or group activity may be assigned. Credit may range from 1/2 to 12 units. Consult class schedule for the offerings a particular semester. May be taken for credit 1-4 times. Pass/No Pass or Pass/No Pass Letter Grade Option or Standard Letter Grade. Fees may be required-Payable at Registration. (UC Credit Limitation/CSU)

Industrial Education Teaching

INDUSTRIAL EDUCATION TEACHING TRANSFER PROGRAM

Students should consult a counselor or www.assist.org for lower division major requirements for most California public universities. (See the Standard Definitions section of the catalog for a description of ASSIST.) Students transferring to an independent college/university should consult the catalog of the individual school and a counselor for lower division major requirements.

Information Systems (IS) — See Computer Information Systems (CIS)

INFORMATION SYSTEMS TRANSFER PROGRAM

Refer to Catalog under: BUSINESS ADMINISTRATION TRANSFER PROGRAM

Students should consult a counselor or www.assist.org for lower division major requirements for most California public universities. (See the Standard Definitions section of the catalog for a description of ASSIST.) Students transferring to an independent college/university should consult the catalog of the individual school and a counselor for lower division major requirements.

Information Technology (IT) — See Computer Information Systems (CIS)

Interdisciplinary Studies

All Divisions

All Division Deans

Faculty

Linda Borla
Melanie Nabahani

Counselors

All Counselors

PROGRAM LEARNING OUTCOMES (PLOs)

The courses taught by this department contribute to the General Education and Basic Skills Program Learning Outcomes. Please refer to General Education and Basic Skills Program Learning Outcomes.

GENERAL STUDIES: FINE ARTS

Associate in Arts Degree

EMPHASIS IN FINE ARTS Program Code: 1A18452

This Area of Emphasis under the Option III — General Studies provides students with the opportunity to earn an Associate in Arts degree, allowing them to understand the intellectual relationships between various disciplines in the Arts. This degree option may include transfer and/or non-transfer course work. Please consult with a counselor for more information.

The Associate of Art Degree in Fine Arts provides students with a scope of knowledge and broad overview for attaining the communication skills, practical knowledge, and training necessary for a variety of careers in the Fine Arts area. Students completing this degree will develop a basic understanding of the arts and how they interrelate.

To earn an Associate Degree students must complete (1) all course requirements with a minimum grade of "C"; (2) 25 units of General Education Graduation Requirements; (3) the cultural diversity and reading requirements; (4) any elective courses to complete a minimum of 60 units; and (5) have a minimum GPA of 2.0. At least 50% of all course work must be completed at Cypress College. Courses that fulfill requirements in an area of emphasis for Associate Degree at Cypress College might not be the same as those required for completing the major at a transfer institution offering a Baccalaureate Degree.

An Associate in Arts Degree includes at least 20 units in Social Sciences, Humanities and Arts courses. An Associate in Science Degree includes at least 20 units in Science, Math and Technical courses.

Required courses:

| Course # | Title | Units |
|------------|---------------------------------------|-------|
| ART 110 C | Introduction to Art | 3 |
| MAD 101 C | Introduction to Computer Graphics/Win | 3 |
| DANC 101 C | Multicultural Dance in the US | 3 |
| JOUR 101 C | Reporting and Writing | 3 |
| MM 100 C | Introduction to Electronic Media | 3 |
| MUS 117 C | American Popular Music | 3 |
| PHOT 101 C | Introduction to Photography | 3 |
| THEA 100 C | Introduction to the Theatre | 3 |

Total Units Required 24

Electives:

To complete all course requirements, students must complete 11 additional units from the list below for a total of 35 units.

No more than six units from any one discipline can be counted towards these units.

Select up to six units

| | | |
|-----------|-----------------------------|---|
| ART 120 C | Two-Dimensional Design | 3 |
| ART 130 C | Introduction to Printmaking | 3 |
| ART 140 C | Graphic Design 1 | 3 |
| ART 150 C | Ceramics Handbuilding | 3 |
| ART 182 C | Beginning Drawing | 3 |

Select up to six units

| | | |
|-----------|--|----------|
| MAD 102 C | Introduction to Mac Web Graphics or Introduction to Win Web Graphics | 3 (3) |
| MAD 103 C | Introduction to MAC 3D Graphics | 3 |
| MAD 104 C | Introduction to WIN 3D Graphics | (3) |
| MAD 105 C | Electronic Illustration/Mac | 3 |
| MAD 112 C | or Electronic Illustrations/Win | (3) |
| MAD 113 C | Digital Imaging/Mac | 3 |
| MAD 134 C | or Digital Imaging/Win | (3) |
| MAD 135 C | Video Editing/MAC | 3 |
| MAD 180 C | | |

Select up to six units

| | | |
|------------|-----------------------|---|
| DANC 105 C | Ballet I | 2 |
| DANC 106 C | Ballet II | 2 |
| DANC 107 C | Modern Dance I | 2 |
| DANC 111 C | Jazz Dance I | 2 |
| DANC 113 C | Tap Dance I | 1 |
| DANC 115 C | Hip Hop Dance | 1 |
| DANC 130 C | Afro-Caribbean Dance | 1 |
| DANC 136 C | Middle Eastern Dance | 1 |
| DANC 137 C | Latin and Swing Dance | 1 |

Select up to six units

| | | |
|---------------------------|-----------------------------------|---|
| ENGL 110 C/ INDS 100 C | Humanities: Ancient and Medieval | 3 |
| ENGL 111 C/ INDS 101 C | Humanities: Renaissance - Present | 3 |

Select up to six units

| | | |
|------------|-------------------------------|---|
| JOUR 118 C | Messages for Electronic Media | 3 |
| JOUR 140 C | Public Relations | 3 |
| JOUR 225 C | Student Media Practicum I | 3 |
| JOUR 226 C | Student Media Practicum II | 3 |
| JOUR 228 C | Visual Journalism | 3 |
| JOUR 229 C | Broadcast Production | 3 |

Select up to six units

| | | |
|------------|---------------------------------|---|
| PHOT 103 C | Intermediate Photography | 3 |
| PHOT 109 C | Portrait Photography | 3 |
| PHOT 203 C | Studio Lighting Techniques | 3 |
| PHOT 204 C | History and Aesthetics of Photo | 3 |
| PHOT 215 C | Digital Photography | 3 |

Select up to six units

| | | |
|------------|-----------------------|---|
| MUS 111 C | The Music Business | 3 |
| MUS 135 C | Jazz History | 3 |
| MUS 119 C | History of Rock Music | 3 |
| MUSA 111 C | Beginning Voice | 1 |
| MUSA 120 C | Beginning Guitar | 1 |
| MUSA 131 C | Keyboard Skills I | 1 |

Select up to six units

| | | |
|-----------------------------|--------------------------------|-----------|
| THEA 107 C | Diversity in American Theater | 3 |
| THEA 108 C | Stage and Screenwriting | 3 |
| THEA 120 C | Acting I | 3 |
| THEA 126 C | Musical Theater Techniques I | 3 |
| THEA 128 C | Acting for the Camera | 3 |
| THEA 143 C | Stagecraft | 3 |
| THEA 144 C | Lighting Design Fundamentals | 3 |
| THEA 145 C | Fundamentals of Costume Design | 3 |
| THEA 146 C | Scene Painting | 3 |
| THEA 147 C | Stage Makeup | 3 |
| Total Units Required | | 35 |

Interdisciplinary Studies (INDS)**INDS 092 C Work Experience-General 3 Units**

Prerequisite: Must be enrolled in seven units, including work experience.

Term hours: 18 lecture and a minimum of five hours of employment per week for each unit of credit. This course provides students with actual work experience through mutual agreement with selected employers. Work may include the acquisition of desirable work habits and attitudes toward jobs. The job held by the student need not be related to the occupational goal of the student. The student may earn no more than three credit units per semester with a maximum total of six during the student's enrollment in any community college. Student's employment need not be limited to the five-hour increment for which the student gains credit. May be taken for credit 3 times.

INDS 100 C Humanities: Ancient and Medieval 3 Units

Same as ENGL 110 C

Prerequisite: Eligibility for ENGL 100 C.

Lecture hours: 54 lecture. This course is a survey of the development of Western culture with a focus upon its Greco-Roman roots, and a study of other important influences, including African and Middle Eastern. The course covers prehistory to the Renaissance, with an emphasis on the arts. Duplicate credit not granted for ENGL 110 C. Cost for museum visits not to exceed \$15.00. (UC/CSU, AA GE, CSU GE, IGETC)

INDS 101 C Humanities: Renaissance-Present 3 Units

Same as ENGL 111 C

Prerequisite: Eligibility for ENGL 100 C.

Term hours: 54 lecture. This course is a survey of the development of Western Culture from the Renaissance to the present, including a study of other important influences from Africa, the Middle East, North and South America, with an emphasis on the arts. Duplicate credit not granted for ENGL 111 C. Cost for museum visits not to exceed \$15.00. (UC/CSU, AA GE, CSU GE, IGETC)

INDS 115 C Learning Communities Seminar 1 Unit

Term hours: 18 lecture. The Learning Communities Seminar is a course specifically designed for students participating in Learning Communities. Students will use both traditional and electronic tools to research, analyze, discuss, and evaluate materials associated with Learning Community themes. May be taken for credit 2 times. Pass/No Pass/Letter Grade Option. (CSU)

INDS 120HC Honors Theme Seminar 1 Unit

Term hours: 18 lecture. The Honors Program Seminar is a course specifically designed for Honors Program students. Students will discuss, research, analyze, and write about Honors education issues. (CSU)

Japanese**Division of Language Arts**

Division Dean — Eldon Young

Faculty

K. Mariye Takahashi

Counselors

Therese Mosqueda-Ponce

Daniel Pelletier

PROGRAM LEARNING OUTCOMES (PLOs)

The courses taught by this department contribute to the General Education and Basic Skills Program Learning Outcomes. Please refer to General Education and Basic Skills Program Learning Outcomes.

JAPANESE TRANSFER PROGRAM

Students should consult a counselor or www.assist.org for lower division major requirements for most California public universities. (See the Standard Definitions section of the catalog for a description of ASSIST.) Students transferring to an independent college/university should consult the catalog of the individual school and a counselor for lower division major requirements.

Japanese (JAPN)**JAPN 098 C Japanese Seminar .5 to 12 Units**

Prerequisite: May be required.

Corequisite: May be required.

Advisory: May be required.

Term hours: 0-216 lecture and/or 0-432 laboratory depending on units attempted. This seminar is for students who wish to extend their knowledge of literature, language and culture through small group discussion. May be taken for credit 1-4 times. Pass/No Pass or Pass/No Pass/Letter Grade Option or Standard Letter Grade. Fees may be required-Payable at Registration.

JAPN 100 C Spoken Japanese for Beginners 3 Units

Term hours: 54 lecture. This course is for students who would like to take conversational Japanese without having to learn the complicated writing system. This will be an introduction to spoken Japanese, with emphasis on vocabulary development, use of the common phrases and culturally appropriate language at beginning levels. Conducted mainly in Japanese through the use of the direct teaching method. Pass/No Pass/Letter Grade Option. (CSU, AA GE)

JAPN 101 C Elementary Japanese I 5 Units

Term hours: 90 lecture. The course emphasizes the acquisition of basic skills in pronunciation, listening, speaking, reading and writing. Students will be introduced to the culture, history and geography of Japan through lectures, slides, videos, photographs, films, and reading assignments. Not intended for native Japanese speakers. Pass/No Pass/Letter Grade Option. (UC/CSU, AA GE, CSU GE)

JAPN 102 C Elementary Japanese II **5 Units**

Prerequisite: JAPN 101 C with a grade of “C” or better or one year of high school Japanese with an average of “C” or better is recommended.

Term hours: 90 lecture. The course continues to emphasize the acquisition of basic skills in pronunciation, listening, speaking, reading, and writing. Students will increase their knowledge of the culture, history, and geography of Japan and Japanese through lectures, films, and reading and writing assignments. Pass/No Pass/Letter Grade Option. (UC/CSU, AA GE, CSU GE, IGEC)

JAPN 200 C Conversational Japanese **2 Units**

Prerequisite: JAPN 102 C with a minimum grade of “C”.

Term hours: 36 lecture. The course(s) will focus on practical conversation with emphasis on the idiomatic usage of the language. Topics concern Japanese life, culture, and current events. Students will prepare for this class through the study of the required textbook, magazines, newspapers and other current materials. The course is conducted in Japanese. Pass/No Pass/Letter Grade Option. (CSU, CSU GE)

JAPN 201 C Study of Kanji **3 Units**

Prerequisite: JAPN 101 C or concurrent enrollment in JAPN 102 C.

Term hours: 54 lecture. This is a low intermediate skill course designed to improve the reading, writing, listening, and understanding of Kanji. Students will practice and learn 420 basic Kanji, as components of more complex Kanji. This will prepare students to take the Japanese government’s proficiency examination at the 10th and 9th level. By repeating the class, students will be able to advance up to the 2nd level. Pass/No Pass/Letter Grade Option. (CSU)

JAPN 203 C Intermediate Japanese III **4 Units**

Prerequisite: JAPN 102 C with a grade of “C” or better or two years of high school Japanese with an average grade of “C”.

Term hours: 72 lecture. The course emphasizes the acquisition of advanced skills in listening, speaking, reading, and writing. Students will be introduced to further elements of the culture, history, and geography of Japan through lectures, slides, films, dialogues and reading assignments conducted in Japanese. Pass/No Pass/Letter Grade Option. (UC/CSU, AA GE, CSU GE, IGEC)

JAPN 204 C Intermediate Japanese IV **4 Units**

Prerequisite: JAPN 203 C with a grade of “C” or better or three years of high school Japanese with an average grade of “C”.

Course hours 72. The course emphasizes the acquisition of advanced skills in listening, speaking, reading, and writing. Students will be introduced to further elements of the culture, history, and geography of Japan through lectures, slides, films, dialogues and reading assignments conducted in Japanese. Pass/No Pass/Letter Grade Option. (UC/CSU), AA GE, CSU GE, IGEC

JAPN 298 C Japanese Seminar **.5 to 12 Units**

Prerequisite: May be required.

Corequisite: May be required.

Advisory: May be required.

Term hours: 0-216 lecture and/or 0-432 laboratory depending on units attempted. This seminar is for students who wish to extend their knowledge of literature, language and culture through small group discussion. May be taken for credit 1-4 times. Pass/No Pass or Pass/No Pass/Letter Grade Option or Standard Letter Grade. Fees may be required-Payable at Registration. (UC Credit Limitation/CSU)

JAPN 299 C Japanese Independent Study **.5 to 2 Units**

Prerequisite: Approved Independent Study Learning Contract.

Term hours: 9-36 lecture/conference depending on units attempted. This course is for able students who wish to increase their knowledge of the Japanese language through individual study or research. Unit credit may range from 1/2 - 2 units in any given semester. May be taken for credit 3 times. Pass/No Pass/Letter Grade Option. (UC Credit Limitation/CSU)

Journalism/Communications

Division of Fine Arts

Division Dean — Katy Realista

Faculty

Vacant

Counselors

Renay Laguana-Ferinac

Renee Ssensalo

PROGRAM LEARNING OUTCOMES (PLOs)

- **Breadth of Knowledge and Experience:** Given the variety of media produced in the newsroom and subject matter to be covered, students will be able to critically analyze information gathering, processing, and distribution in the context of mass media history
- **Communication:** Given the variety of media produced in the newsroom and subject matter to be covered, students will be able to discuss information gathering, processing, and distribution in the context of mass media history.
- **Critical Thinking:** Given the variety of media produced in the newsroom and subject matter to be covered, students will be able to identify information gathering, processing, and distribution systems in the context of mass media history.
- **Self Development:** Given the variety of media produced in the newsroom and subject matter to be covered, students will be able to personalize the social and psychological aspects of information gathering, processing, and distribution systems in the context of mass media history.

ASSOCIATE IN ARTS IN JOURNALISM

FOR TRANSFER

Program Code: 1A35300

This curriculum is designed to provide an opportunity for the Journalism major to achieve an Associate in Arts Degree in Journalism for Transfer (AA-T in Journalism) which completes the first and second year requirements for transfer to a four-year public California institution. While at least a baccalaureate degree is recommended, completion of this curriculum will also demonstrate commitment to the field and provide comprehensive preparation for further academic study through upper division course work. This curriculum specifically prepares the prospective transfer student for upper division coursework in Journalism or a similar major at a California State University (CSU) campus. Students should consult a counselor, the Transfer Center, and the catalog of the transfer college or university to plan a specific program of study to meet the college or university’s requirements.

Note: Courses that fulfill major requirements for an Associate Degree for Transfer at Cypress College might not be the same as those required for completing the major at all transfer institutions offering a Baccalaureate Degree. The Student Transfer Achievement Reform Act (Senate Bill 1440, now codified in California Education Code sections 66746–66749) guarantees admission to a California State University (CSU) campus for any community college student who completes an “associate degree for transfer”, a newly established variation of the associate degrees traditionally offered at a California community college. The Associate in Arts for Transfer in Journalism is intended for students who plan to complete a bachelor’s degree in a similar major at a CSU campus. Students completing these degrees (AA-T or AS-T) are guaranteed admission to the CSU system, but not to a particular

campus or major. Students transferring to a CSU campus that does accept the AA-T or AS-T will be required to complete no more than 60 units after transfer to earn a bachelor's degree (unless the major is designated "high-unit" major). This degree may not be the best option for students intending to transfer to a particular CSU campus or to a university or college that is not part of the CSU system. Students with an AA-T in Journalism may pursue careers in Journalism, Public Relations and Advertising as well as careers in a variety of mass communication media, including integrated, digital media on the internet and careers in traditional media such as print and broadcasting.

To earn an AA-T in Journalism, students must complete: (1) a minimum of 18 semester units or 27 quarter units of major course requirements with a minimum grade of "C"; (2) California State University General Education Breadth requirements (CSU GE Breadth) or the Intersegmental General Education Transfer Curriculum (IGETC); (3) any elective courses to complete a minimum of 60 units of CSU transferable coursework; (4) have an overall GPA of 2.0.

| Required Core Courses (9 units): | | Units |
|---|---------------------------|--------------|
| JOUR 101 C | Reporting and Writing | 3 |
| JOUR 110 C | Global Media | 3 |
| JOUR 225 C | Student Media Practicum I | 3 |

| List A (Select 3 units from the following): | | Units |
|--|----------------------------|--------------|
| JOUR 130 C | Visual Communication | 3 |
| JOUR 140 C | Public Relations | 3 |
| JOUR 226 C | Student Media Practicum II | 3 |
| JOUR 228 C | Visualjournalism | 3 |

| List B (select 6-8 units from the following) | | Units |
|---|---|--------------|
| PHOT 101 C | Introduction to Photography | 3 |
| MAD 140 C | DeskTop Publishing 1/Mac or | 3 |
| MAD 141 C | DeskTop Publishing 1/Win | (3) |
| MATH 120 C | Introduction to Probability and Statistics or | 4 |
| PSY 161 C | Probability and Statistics-Social Sciences or | (4) |
| PSY 161HC | Honors Probability and Statistics-Soc Sci or | (4) |
| SOC 161 C | Probability and Statistics-Social Sciences or | (4) |
| SOC 161HC | Honors Probability and Statistics-Social Sciences | (4) |
| COMM 135 C | Argument and Critical Thinking | 3 |
| ECON 100 C | Principles of Economics-Macro or | 3 |
| ECON 100HC | Honors Principles of Economics | (3) |
| ECON 105 C | Principles of Economics-Micro or | 3 |
| ECON 105HC | Honors Principles of Economics | (3) |
| ENGL 103 C | Critical Reasoning and Writing | 4 |
| PHIL 175 C | Symbolic Logic | 3 |
| POSC 100 C | United States Government or | 3 |
| POSC 100HC | Honors United States Government | (3) |
| POSC 215 C | Comparative Politics | 3 |
| Total Units | | 18–20 |

COMMUNICATIONS TRANSFER PROGRAM

Students should consult a counselor or www.assist.org for lower division major requirements for most California public universities. (See the Standard Definitions section of the catalog for a description of ASSIST.) Students transferring to any college/university should consult the catalog of the individual school and a counselor for lower division major requirements.

Journalism/Communications (JOUR)

JOUR 101 C Reporting and Writing 3 Units

Prerequisite: Eligibility for ENGL 100 C.

Advisory: Ability to type 20 words per minute.

Term hours: 54 lecture. An introduction to gathering, synthesizing/organizing and writing news in journalistic style across multiple platforms. Includes role of the journalist and related legal and ethical issues. Students will report and write based on their original interviews and research to produce news content. Experiences may include covering speeches, meetings and other events, writing under deadline and the use of Associated Press Style. (UC/CSU, C-ID: JOUR 110)

JOUR 110 C Global Media 3 Units

Term hours: 54 lecture. Survey of global mass communication and the inter-relationships of media with society including history, structure and trends in a digital age. Discussion of theories and effects, economics, technology, law and ethics, global media, media literacy, and social issues, including gender and cultural diversity. (UC/CSU, AA GE, CSU GE, C-ID: JOUR 100)

JOUR 118 C Messages for Electronic Media 3 Units

Term hours: 54 lecture. A speech and mass communications class that investigates the history, theory, contemporary issues, and current law in broadcasting, cable and the Web. Students create and broadcast video and audio presentations in addition to learning through lecture and reading. (CSU, CSU GE)

JOUR 130 C Visual Communication 3 Units

Formerly MM 110 C

Term hours: 54 lecture. Survey of the significant techniques and examples of visual communication as employed by the mass media, including the World Wide Web, newspapers, magazines, television, and advertising. Discussion and demonstration of the tools used in analyzing visual communication. Creation and analysis of images for print, Web and video. (UC/CSU, C-ID: JOUR 170)

JOUR 140 C Public Relations 3 Units

Advisory: Ability to type 20 WPM and understand basic computer operations.

Term hours: 54 lecture. Principles, history and development, and professional practice of modern public relations. Includes concepts of planning and executing effective communications strategies, including message design and distribution, for any organization. (CSU, C-ID: JOUR 150)

JOUR 225 C Student Media Practicum I 3 Units

Advisory: Should be able to type 20 words per minute.

Term hours: 36 lecture and 54 laboratory. The students daily produce, under the direction of student editors and producers, news and feature content for student media. Student media includes World Wide Web publications, print publications, video production for file streaming and podcasting, live Webcast streaming of audio and video productions, the use of social networking tools, and, possibly, public access cable television. Student media serves students, staff and faculty on campus plus a community audience. Students will learn the basics of design/layout; visual, online and multimedia journalism, and explore emerging technologies. Students will report to advanced student editors in a newsroom in which students control all content. (CSU, C-ID: JOUR 130)

JOUR 226 C Student Media Practicum II **3 Units**

Prerequisite: JOUR 225 C with a minimum grade of "C".

Advisory: Should be able to type 20 words per minute.

Term hours: 36 lecture and 54 laboratory. This course requires higher skill level and/or leadership/management involvement than JOUR 226 C. The students daily produce, under the direction of student editors and producers, news and feature content for student media. Student media includes World Wide Web publications, print publications, video production for file streaming and podcasting, live Webcast streaming of audio and video productions, the use of social networking tools, and, possibly, public access cable television. Student media serves students, staff and faculty on campus plus a community audience. Students will learn the basics of design/layout; visual, online and multimedia journalism, and explore emerging technologies. Advanced students learn to be editors in a newsroom in which students control all content. (CSU, C-ID: JOUR 131)

JOUR 228 C Visualjournalism **3 Units**

Advisory: Should be able to type 20 words per minute.

Term hours: 54 lecture. This course trains visualjournalists who use video and still imaging for electronic news gathering. It focusing on theory and practice in press and publications photography, with emphasis on using the DSLR camera as a reporting and communications tool. Covered are news and feature photography and photographic essays, including composition, impact, and creativity, for print, World Wide Web, broadcast, and Webcasting. (CSU, C-ID: JOUR 160)

JOUR 229 C Broadcast Production **3 Units**

Advisory: Should be able to type 20 words per minute.

Term hours: 54 lecture. Emphasis is on creating broadcast television and radio-style programming for posting as files and for streaming on the internet as well as for distributing conventionally. The course is taught in a newsroom using the media convergence model in which students work alongside of, and share their production with, other campus media. Skills developed include broadcast writing, videography, audio and video production, and internet distribution, plus managing media and advertising. (CSU)

JOUR 230 C Video for Photographers **3 Units**

Prerequisite: Completion of or concurrent enrollment in PHOT 101 C with a minimum grade of "C".

Term hours: 54 lecture. Video for Photographers introduces the photographer to the use of a single device--a digital camcorder with frame capture or a digital camera with high-definition video, or a hybrid device--for simultaneous video and still imaging. The student learns single-camera and three-camera production techniques on location and in the studio. The course includes using the still camera motor drive as a digital video tool. The student's project will include: Treatments, scripts, shooting scripts, shooting video, shooting sequential photographs, basic audio, logging, edit decision lists, frame capture, video editing software, slideshow production, and presentation in a multimedia presentation platforms. This course gives basic video skills to the photographer who must work in video, also, for multimedia. (CSU)

JOUR 298 C Communication/Journalism Seminar **.5 to 12 Units**

Prerequisite: May be required.

Corequisite: May be required.

Advisory: May be required.

Term hours: 0-216 lecture and/or 0-648 laboratory depending on units attempted. This seminar is for able students who wish to extend their knowledge of literature, language and culture through small group discussion. Fees may be required-Payable at Registration. May be taken for credit 4 times. Pass/No Pass or Pass/No Pass/Letter Grade Option or Standard Letter Grade. (UC Credit Limitation/CSU)

JOUR 299 C Independent Study **.5 to 2 Units**

Prerequisite: Approved Independent Study Learning Contract.

Term hours: 0-36 lecture and/or 0-108 laboratory depending on units attempted. Students enroll who wish to increase their knowledge of journalism through individual study, research or internships. Permission of the instructor is required along with a contract outlining a student's independent work and the supervision of the instructor. May be taken for credit 4 times. (CSU)

Kinesiology

(formerly) Physical Education

Division of Kinesiology and Athletics

Division Dean — Richard Rams

Faculty

Andrew Alhadeff

Larry Beidler

Jeff Benito

Silvie Grote

Anthony Hutting

Margaret Mohr

Brad Pickler

Bill Pinkham

Nancy Welliver

Counselor

Dana Bedard

PROGRAM LEARNING OUTCOMES (PLOs)

Upon completion of the kinesiology program, students will be able to

- Identify various career opportunities within the field of kinesiology.
- Demonstrate an understanding of the anatomical structure and physiological function of the body at rest and in human performance.
- Apply the principles of physical fitness development and maintenance as well as the body's responses to physical activity.
- Recognize factors instrumental in the development and performance of motor skills.
- Demonstrate an understanding of the value and significance of physical activity for human development, human interactions, and quality of life.
- Display leadership, effective communication, and skill set related to the field.
- Appreciate and endorse the value of lifelong fitness.

Upon completion of the public health science program, students will be able to

- Describe the core functions of public health.
- Identify various career opportunities within the field of public health.
- Apply critical analysis skills to contemporary health issues.
- Assess the fundamental characteristics and organizational structures of the U.S. Health system and note significant differences in systems in other countries.
- Discuss the role of community engagement in promoting public health and social justice.
- Describe risk factors and modes of transmission for infectious and chronic diseases and how these diseases affect both personal and public health.
- Appreciate the multiple determinants of health, including sociological, economic, genetic, behavioral, environmental, and other factors that impact human health and health disparities.
- Apply the basic concepts, methods, and tools of public health data collection, use, and analysis and explain why evidence-based approaches are an essential part of public health practice.
- Endorse lifestyle behaviors that promote individual and public health and well-being.
- Value multicultural perspectives and sensitivities on health.

Course Repeatability Limitations

Effective 2013, most active participatory courses in Art, Dance, Theater, Music, and Kinesiology are no longer repeatable. The courses in the table below are related in content and therefore have been identified in distinct “family” groupings in which students are limited to a maximum of 4 course enrollments per family (withdrawals and substandard grades will be counted towards the 4 enrollment maximum). Note: Exceptions for courses still designated as repeatable are indicated in course descriptions of the college catalog and class schedules with the statement, “May be taken for credit ____ times.” If students are majoring in any of these disciplines, they are advised to see their counselor to discuss options.

ASSOCIATE IN ARTS IN KINESIOLOGY FOR TRANSFER DEGREE (AA-T)

Program Code: 1A32135

This curriculum is designed to provide an opportunity for the Kinesiology major to achieve an Associate in Arts in Kinesiology for Transfer (AA-T in Kinesiology) which completes the first and second year requirements for transfer to a four-year public California institution. While at least a baccalaureate degree is recommended preparation for those considering professional careers, completion of this curriculum will demonstrate commitment to the field and provide comprehensive preparation for further academic study through upper-division course work. This curriculum specifically prepares the prospective transfer student for upper division course work in Kinesiology or a similar major at a California State University (CSU) campus. Students should consult a counselor, the Transfer Center and the catalog of the transfer college or university to plan a specific program of study to meet the college or university's requirements.

Note: Courses that fulfill major requirements for an Associate Degree for Transfer at Cypress College might not be the same as those required for completing the major at all transfer institutions offering a Baccalaureate Degree. The Student Transfer Achievement Reform Act (Senate Bill 1440, now codified in California Education Code sections 66746–66749) guarantees admission to a California State University (CSU) campus for any community college student who completes an “associate degree for transfer,” a newly established variation of the associate degrees traditionally offered at a California community college. The AA-T is intended for students who plan to complete a bachelor's degree in a similar major at a CSU campus. Students completing these degrees (AA-T) are guaranteed admission to the CSU system, but not to a particular campus or major. Students transferring to a CSU campus that does accept the AA-T will be required to complete no more than 60 units after transfer to earn a bachelor's degree (unless the major is designated “high-unit” major). This degree may not be the best option for students intending to transfer to a particular CSU campus or to a university or college that is not part of the CSU system. Students should consult with a counselor when planning to complete the degree for more information on university admission and transfer requirements. Students with a degree in Kinesiology may pursue careers in a variety of health science professions including physical training, physical therapy, fitness instruction, coaching and athletics. The completion of this curriculum will demonstrate commitment to the field and provide comprehensive preparation for upper-division work.

To earn an AA-T in Kinesiology students must complete the following requirements: (1) a minimum of 18–23 semester units or 27–34.5 quarter units in the Kinesiology major with a minimum grade of “C”; (2) California State University General Education Breadth requirements (CSU GE Breadth) or the Intersegmental General Education Transfer Curriculum (CSU IGETC); (3) completion of 60 semester or 90 quarter units of CSU transferable course work; and (4) have an overall GPA of 2.0.

| Required Core Courses: 11–14 units | | Units |
|---|--------------------------------|--------------|
| PE 252 C | Introduction to Kinesiology | 3 |
| BIOL 231 C | General Human Anatomy and | 4 |
| BIOL 241 C | General Human Physiology or | 4 |
| BIOL 210 C | Anatomy and Physiology | (5) |

Select a one (1) unit course from any three (3) of the following areas for a maximum of three units: (Aquatics, Combatives, Team Sports, Individual Sports, Fitness)

| Fitness | | Units |
|----------------|--------------------------------|--------------|
| PE 102 C | Yoga | 1 |
| PE 104 C | Athletic Weight Training | 1 |
| PE 121 C | Walking for Fitness | 1 |
| PE 129 C | Step Aerobics | 1 |
| PE 142 C | Mountaineering/Rock Climbing | 1 |
| PE 148 C | Low-Impact Aerobics | 1 |
| PE 150 C | Rhythmic Aerobic Exercise | 1 |
| PE 152 C | Fitness Training Lab | 1 |
| PE 156 C | Power Training | 1 |
| PE 159 C | Strength Training | 1 |
| PE 161 C | Body Conditioning/Fitness | 1 |
| PE 162 C | Conditioning for Athletes | 1 |
| PE 178 C | Core Strength and Stability | 1 |
| PE 182 C | Body Building and Development | 1 |
| PE 187 C | Physical Fitness | 1 |
| PE 193 C | Weight Training/Weight Lifting | 1 |

| | | |
|---|---|--------------|
| Individual Sports | | Units |
| PE 105 C | Badminton | 1 |
| PE 108 C | Bowling | 1 |
| PE 115 C | Golf | 1 |
| PE 119 C | Gymnastics — Tumbling | 1 |
| PE 122 C | Surfing | 1 |
| PE 139 C | Tennis | 1 |
| PE 141 C | Specialized Tennis Skills | 1 |
| PE 157 C | Specialized Golf Skills | 1 |
| Aquatics | | Units |
| PE 134 C | Swimming | 1 |
| PE 135 C | Swimming — Intermediate/Advanced | 1 |
| PE 136 C | Springboard Diving | 1 |
| PE 149 C | Swim for Fitness | 1 |
| PE 151 C | Water Aerobics/Pool Exercises | 1 |
| Combatives | | Units |
| PE 163 C | Kick-Boxing | 1 |
| PE 170 C | Self Defense | 1 |
| Team Sports | | Units |
| PE 109 C | Futsal (Indoor Soccer) | 1 |
| PE 144 C | Volleyball — Beginning | 1 |
| PE 145 C | Volleyball — Intermediate/Advanced | 1 |
| PE 146 C | Water Polo | 1 |
| PE 160 C | Basketball | 1 |
| PE 171 C | Soccer | 1 |
| PE 172 C | Softball | 1 |
| PE 180 C | Baseball | 1 |
| PE 181 C | Basketball | 1 |
| PE 189 C | Soccer | 1 |
| List A: Select two courses (minimum 7–9 units) from the following: | | Units |
| MATH 120 C | Introduction to Probability and Statistics | 4 |
| | or | |
| PSY 161 C | Probability and Statistics — Social Sciences | (4) |
| | or | |
| PSY 161HC | Honors Probability and Statistics — Social Sciences | (4) |
| | or | |
| SOC 161 C | Probability and Statistics — Social Sciences | (4) |
| | or | |
| SOC 161HC | Honors Probability and Statistics — Social Sciences | (4) |
| CHEM 101 C | Chemistry for Health Science Majors I | 5 |
| | or | |
| CHEM 111AC | General Chemistry I | (5) |
| PHYS 201 C | College Physics I | 4 |
| PE 235 C | First Aid, CPR and Emergencies | 3 |
| Total Units Required | | 18–23 |

**ASSOCIATE IN ARTS DEGREE
PHYSICAL EDUCATION Program Code: 1A03769**

This program is designed to prepare students with a knowledgeable base of physical fitness, health practices, and professional activities for entry into the discipline of physical education/athletics. Further specialization is possible by combining the Associate of Arts Degree with electives chosen from a certificate program in aerobics, aquatics, or coaching. A student may also elect to work toward a transfer program preparing for entry to a four-year institution.

To earn an Associate Degree students must complete: (1) all major course requirements with a minimum grade of “C”; (2) 25 units of General Education Graduation Requirements; (3) the cultural diversity and reading requirements; (4) any elective courses to complete a minimum of 60 units; and, (5) have a minimum GPA of 2.0. At least 50% of all major course work must be completed at Cypress College.

Courses that fulfill major requirements for an Associate Degree at Cypress College might not be the same as those required for completing the major at a transfer institution offering a Baccalaureate Degree. For information on specific university requirements, please consult with your counselor, or visit the Transfer Center.

Required courses are listed in suggested sequence:

| Course # | Title | Units |
|-----------------|--|--------------|
| *BIOL 101 C | General Biology | 5 |
| | or | |
| BIOL 102 C | Human Biology | (3) |
| | or | |
| BIOL 160 C | Integrated Medical Science | (3) |
| | or | |
| BIOL 210 C | Anatomy and Physiology | (5) |
| | or | |
| BIOL 231 C | General Human Anatomy | (4) |
| PE 252 C | Introduction to Kinesiology | 3 |
| PE 234 C | Contemporary Personal Health | 3 |
| | or | |
| PE 244 C | Human Performance | (3) |
| PE 235 C | First Aid, CPR and Emergencies | 3 |
| | or | |
| PE 250 C | Sport and United States Society | (3) |
| | and | |
| | Choose at least 3 units from Physical Education activity courses 100–222 | 3 |

Electives

| Choose one of the following courses | | Units |
|--|---------------------------------------|--------------|
| PE 231 C | Elementary School Movement — PE | 3 |
| PE 236 C | Prevention and Care/Athletic Injuries | 3 |
| PE 240 C | Sports Officiating | 3 |
| PE 247 C | Sports Management | 3 |
| PE 244 C | Human Performance | 3 |
| PE 248 C | Psychology of Sport | 3 |
| PE 266 C | Theory of Coaching Basketball | 3 |
| PE 267 C | Theory of Coaching Baseball | 3 |
| REC 101 C | Principles of Community Recreation | 3 |
| HRC 100 C | Nutrition | 3 |
| BIOL 241 C | General Human Physiology | 4 |
| Total Units Required | | 18–21 |

*A score of 3 or higher on the Advanced Placement (AP) Biology exam meets this requirement upon petition through Admissions and Records. See a counselor for more information.

**AEROBIC INSTRUCTOR
CERTIFICATE****Program Code: 1C07828**

Primary emphasis is to prepare the student for occupational competency in aerobic exercise instruction for corporate fitness or health clubs. All students must complete 14 units. Course work in PE 235 C may be waived with current Red Cross cards in First Aid and CPR at the discretion of the division.

To earn a certificate, students must complete the required courses as listed with a minimum grade of "C." At least 50% of all course work must be completed at Cypress College.

Required courses are listed in suggested sequence:

| Course # | Title | Units |
|----------|---|-------|
| PE 161 C | Body Conditioning/Fitness | 1 |
| PE 178 C | or Core Strength and Stability | (1) |
| PE 129 C | Step Aerobics | 1 |
| PE 235 C | First Aid, CPR and Emergencies | 3 |
| PE 236 C | or Prevention and Care/Athletic Injuries | (3) |
| PE 244 C | Human Performance | 3 |
| PE 234 C | or Contemporary Personal Health | (3) |
| PE 299 C | Physical Education Independent Study | 1 |

Select 5–7 units from the electives listed below:

| Electives | Units | |
|-----------------------------|----------------------------------|--------------|
| PE 152 C | Fitness Training Lab | 0.5–2 |
| PE 252 C | Introduction to Kinesiology | 3 |
| PE 114 C | Cardiovascular Conditioning | 1 |
| PE 151 C | Water Aerobics/Pool Exercises | 1 |
| *BIOL 101 C | General Biology | 5 |
| BIOL 102 C | or Human Biology | (3) |
| BIOL 160 C | or Integrated Medical Science | (3) |
| BIOL 231 C | or General Human Anatomy | (4) |
| HRC 100 C | Nutrition | 3 |
| Total Units Required | | 14–16 |

*A score of 3 or higher on the Advanced Placement (AP) Biology exam meets this requirement upon petition through Admissions and Records. See a counselor for more information.

**AQUATICS SPECIALIST
CERTIFICATE****Program Code: 1C07829**

Primary emphasis is to prepare the student for occupational competency in swimming instruction as recommended by the state of California and the American Red Cross. All students must complete 13 units. Course work in PE 235 C, PE 237 C, and PE 238 C may be waived with current Red Cross cards in First Aid and CPR, Life Guarding and Water Safety Instruction at the discretion of the division.

To earn a certificate, students must complete the required courses as listed with a minimum grade of "C." At least 50% of all course work must be completed at Cypress College.

Required courses are listed in suggested sequence:

| Course # | Title | Units |
|----------|----------------------------------|-------|
| PE 135 C | Swimming — Intermediate/Advanced | 1 |
| PE 235 C | First Aid, CPR and Emergencies | 3 |
| PE 237 C | Lifeguarding | 1 |
| PE 238 C | Water Safety Instruction and | 2 |

Select a total of 3 units from the following courses

| | | |
|----------|--------------------------------------|-------|
| PE 136 C | Springboard Diving | 0.5–1 |
| PE 146 C | Water Polo | 0.5–1 |
| PE 149 C | Swim for Fitness | 0.5–1 |
| PE 151 C | Water Aerobics/Pool Exercises | 0.5–1 |
| PE 152 C | Fitness Training Lab | 0.5–2 |
| PE 299 C | Physical Education Independent Study | 0.5–2 |

Select a total of 3–5 units from the electives**listed below (unless taken as an option for required courses)**

| Electives | Units | |
|-----------------------------|----------------------------------|--------------|
| PE 136 C | Springboard Diving | 1 |
| PE 146 C | Water Polo | 1 |
| PE 149 C | Swim for Fitness | 1 |
| PE 151 C | Water Aerobics/Pool Exercises | 1 |
| PE 152 C | Fitness Training Lab | 1 |
| PE 247 C | Sports Management | 3 |
| PE 248 C | Psychology of Sport | 3 |
| *BIOL 101 C | General Biology | 5 |
| BIOL 102 C | or Human Biology | (3) |
| BIOL 160 C | or Integrated Medical Science | (3) |
| BIOL 231 C | or General Human Anatomy | (4) |
| Total Units Required | | 13–15 |

*A score of 3 or higher on the Advanced Placement (AP) Biology exam meets this requirement upon petition through Admissions and Records. See a counselor for more information.

**ATHLETIC COACH
CERTIFICATE****Program Code: 1C07830**

Primary emphasis is to prepare the student for occupational coaching at various levels. All students must complete 15–17 units. Course work in PE 235 C may be waived with current Red Cross cards in First Aid and CPR at the discretion of the division.

To earn a certificate, students must complete the required courses as listed with a minimum grade of "C." At least 50% of all course work must be completed at Cypress College.

Required courses are listed in suggested sequence:

| Course # | Title | Units |
|---|---|-------|
| PE 235 C | First Aid, CPR and Emergencies | 3 |
| PE 236 C | or Prevention and Care/Athletic Injuries | (3) |
| PE 244 C | Human Performance | 3 |
| PE 234 C | or Contemporary Personal Health | (3) |
| PE 248 C | Psychology of Sport | 3 |
| Choose at least 3 units from Physical Education activity courses PE 100–222 | | 3 |

Select 3–5 units from the electives listed below

| Electives | Units | |
|-----------------------------|--------------------------------------|--------------|
| PE 252 C | Introduction to Kinesiology | 3 |
| PE 240 C | Sports Officiating | 3 |
| PE 250 C | Sport and United States Society | 3 |
| PE 299 C | Physical Education Independent Study | 0.5–2 |
| PE 247 C | Sports Management | 3 |
| PE 266 C | Theory of Coaching Basketball | 3 |
| PE 267 C | or Theory of Coaching Baseball | (3) |
| Total Units Required | | 15–17 |

KINESIOLOGY TRANSFER PROGRAM

Students should consult a counselor or www.assist.org for lower division major requirements for most California public universities. (See the Standard Definitions section of the catalog for a description of ASSIST.) Students transferring to an independent college/university should consult the catalog of the individual school and a counselor for lower division major requirements.

For additional courses related to Recreation, please refer to the Recreation Department

Kinesiology (KIN)

KIN 100 C Adapted Kinesiology Weight Training .5-1 Units

Formerly PE 100 C

Prerequisite: This course is expressly designed for, but not limited to, students with permanent disability.

Term hours: 27-54 hours activity depending on units attempted. This course is designed to give students with various levels of physical ability the opportunity to participate in resistive exercises with weights. May be taken for credit 4 times. (UC Credit Limitation/CSU, AA GE, CSU GE)

KIN 101 C Adapted Kinesiology Activity .5-1 Units

Formerly PE 101 C

Prerequisite: This course is expressly designed for, but not limited to, students with permanent disability.

Term hours: 27-54 hours activity depending on units attempted. This course is designed for students with various levels of physical ability. The class will emphasize modified individual and team sport activities. May be taken for credit 4 times. (UC Credit Limitation/CSU, AA GE, CSU GE)

KIN 109 C Spirit Squad 1-2 Units

Formerly PE 179 C

Prerequisite: Audition.

Term hours: 108 hours activity depending on units attempted. This course is designed for the pep squad to develop skills in tumbling, stunts, dance technique, choreography, leadership skills, crowd motivation, and competition. Performance is mandatory at school athletic events and campus functions. (CSU, AA GE, CSU GE)

KIN 110 C Surfing .5-1 Units

Formerly PE 122 C

Prerequisite: Demonstrate ability to swim.

Term hours: 27-54 hours activity depending on units attempted. This course offers students the opportunity to learn and improve the skills of wave riding. Examination and analysis of paddling, wave selection, water safety, equipment, tides, current, and etiquette are emphasized for long boarding and short boarding. Transportation will not be furnished. (UC Credit Limitation/CSU, AA GE, CSU GE)

KIN 111 C Swimming .5-1 Units

Formerly PE 134 C

Term hours: 27-54 hours activity depending on units attempted. This course provides basic instruction and practice in the fundamental elements of swimming including beginning diving and water safety instruction. The class is designed to develop proficiency in the basic strokes needed to meet the prerequisites for the senior lifesaving and water safety instruction courses. (UC Credit Limitation/CSU, AA GE, CSU GE)

KIN 112 C Swimming-Intermediate-Advanced .5-1 Units

Formerly PE 135 C

Prerequisite: Demonstrate ability to swim.

Advisory: KIN 111 C

Term hours: 27-54 hours activity depending on units attempted. This course is designed to develop knowledge and skill in competitive swimming strokes. The swimming strokes to be taught are the American crawl, backstroke, breaststroke and dolphin butterfly. The class will emphasize the development of cardiovascular aerobic conditioning. (UC Credit Limitation/CSU, AA GE, CSU GE)

KIN 114 C Surfing .5-1 Units

Formerly PE 136 C

Prerequisite: Demonstrate ability to swim.

Term hours: 27-54 hours activity depending on units attempted. This course is designed to teach the fundamentals of springboard diving. The beginning diver will learn diving progression for the front, back, reverse, inward and twisting dives. (UC Credit Limitation/CSU, AA GE, CSU GE)

KIN 116 C Swim for Fitness .5-1 Units

Formerly PE 149 C

Prerequisite: Demonstrate ability to swim.

Term hours: 27-54 hours activity depending on units attempted. This course will emphasize swimming for health and physical fitness. The class is designed to decrease the risk of coronary heart disorders by increasing heart efficiency, vital lung capacity, and the knowledge of each through the use of aerobic and anaerobic conditioning. Participating adults and others seeking a fitness program may expect to improve their overall fitness level through aquatic training. (UC Credit Limitation/CSU, AA GE, CSU GE)

KIN 117 C Water Aerobics .5-1 Units

Formerly PE 151 C

Term hours: 27-54. This class is designed to provide calisthenic type exercises and routines using the resistance of the water as a means for developing cardiovascular endurance, strength, flexibility, and coordination. Students will be able to improve posture and appearance through performance and understanding of using the water as a resistance. Non-swimmers welcome. (UC Credit Limitation/CSU, AA GE, CSU GE)

KIN 120 C Kick-Boxing .5-1 Units

Formerly PE 163 C

Term hours: 27-54 hours activity depending on units attempted. Instruction in forms of kick-boxing that stress cardiovascular endurance, strength development, and improved flexibility. The aerobic workout will include influences from several martial arts. The sparring and self defense aspects of kick-boxing will be included. (UC Credit Limitation/CSU, AA GE, CSU GE)

KIN 121 C Self Defense .5-1 Units

Formerly PE 170 C

Term hours: 27-54 hours activity depending on units attempted. This course provides instruction in developing both physical and cognitive skills in personal safety and self-protection. Through different forms of martial arts training, students will practice both defensive and offensive moves against various forms of attacks, including weapons. Proficiency in the practical, effective, and tactical use of movement, leverage, strikes, and use of everyday objects. (UC Credit Limitation/CSU, AA GE, CSU GE)

KIN 130 C Yoga .5-1 Units

Formerly PE 102 C

Term hours: 27-54 hours activity depending on units attempted. This is an overview course in yoga, an integrated study of health. It involves the investigation and practice of breathing techniques, yoga postures (asanas), and meditation and relaxation. Emphasis is on practicing the principles of pranayama (breathing) and deep relaxation to reduce stress, improving concentration, circulation and flexibility, and unifying body, mind and spirit. The asana portion will also help to tone and strengthen muscles. (UC Credit Limitation/CSU, AA GE, CSU GE)

KIN 131 C Restorative Yoga 3 Units

Term hours: 27-54 hours activity depending on units attempted. This course explores the relationship between yoga and its connection as one of several holistic methods to manage the mind, body, and spiritual effects of stress. It is designed to promote enhanced performance and function. Its focus is the practice of breathing, relaxation, longer time in asanas, meditation, positive thinking and other related techniques. (UC Credit Limitation/CSU, AA GE, CSU GE)

KIN 132 C Hatha Yoga .5-1 Units

Term hours: 27-54 lab hours depending on units attempted. This course involves the investigation and practice of Hatha Yoga principles as it pertains to Raja Yoga. It is designed to improve proper technique within postures (asanas) and associated breathing techniques; body balance, awareness, alignment and relaxation; joint flexibility, coordination; muscle tone; and stress management. (UC Credit Limitation/CSU, AA GE, CSU GE)

KIN 133 C Cardiovascular Conditioning .5-1 Units

Formerly PE 114 C

Term hours: 27-54 hours activity depending on units attempted. This class is designed to provide an individualized exercise program for the student interested in achieving physical fitness through a program of cardiovascular conditioning. (UC Credit Limitation/CSU, AA GE, CSU GE)

KIN 134 C Walking for Fitness .5-1 Units

Formerly PE 121 C

Term hours: 27-54 hours activity depending on units attempted. This course will emphasize walking for health and fitness for men and women who are interested in instruction and practice of cardiovascular walking. This class is designed to decrease the risk of coronary heart disorders by increasing heart efficiency, vital lung capacity, and the knowledge of each through aerobic and anaerobic conditioning. (UC Credit Limitation/CSU, AA GE, CSU GE)

KIN 135 C Step Aerobics .5-1 Units

Formerly PE 129 C

Term hours: 27-54 hours activity depending on units attempted. This course provides aerobic development through coordinated stepping movements performed to music. The class will emphasize cardiovascular improvement, muscle development, and decreased body fat. (UC Credit Limitation/CSU, AA GE, CSU GE)

KIN 136 C Step Aerobics Intermediate .5-1 Units*Advisory: KIN 135 C*

Term hours: 27-54 hours activity depending on units attempted. This course provides aerobic development through coordinated stepping movements performed to music. The class will emphasize cardiovascular improvement, muscle development, and decreased body fat. (UC Credit Limitation/CSU, AA GE, CSU GE)

KIN 137 C Mountaineering and Rock Climbing .5-1 Units

Formerly PE 142 C

Term hours: 27-54 hours activity depending on units attempted. This course is designed for those students wishing to develop beginning through advanced skills in mountaineering/rock climbing. Teaching emphasis is on preparation, knowledge of equipment, physical techniques and the mental approach to climbing. Facility use fee required, to be paid throughout the semester at the facility. (UC Credit Limitation/CSU, AA GE, CSU GE)

KIN 138 C Body Sculpt .5-1 Units

Formerly PE 148 C

Term hours: 27-54 hours activity depending on units attempted. This course provides a whole body workout without jogging, running, jumping or other high impact type movements which might result in overstress to feet, ankles, knees, hips or the spinal column. This course is designed to prevent injury and is ideal for beginning exercisers, individual with higher body mass, injured or recuperating students, older students as well as the general student population. This class is designed for both men and women. (UC Credit Limitation/CSU, AA GE, CSU GE)

KIN 139 C Cardio Blast .5-1 Units

Formerly PE 150 C

Term hours: 27-54 hours activity depending on units attempted. This course provides an aerobic development through rhythmic, high impact movements. The class activities will emphasize stretching, walking, jogging, running, and rope jumping in a dance setting to music. (UC Credit Limitation/CSU, AA GE, CSU GE)

KIN 140 C Fitness Training .5-1 Units

Formerly PE 152 C

Term hours: 27-54 hours activity depending on units attempted. Circuit training has proven especially beneficial for people not interested in competitive weight training but desiring good muscle tone and cardiovascular fitness. This type of training gives maximum return in a controlled workout. (UC credit limitation/CSU, AA GE, CSU GE)

KIN 141 C Spinning .5-1 Units

Term Hours: 27-54 lab hours depending on units attempted. Spinning is a unique, indoor, group stationary cycling program. This efficient, high-energy group exercise integrates music and cycling in a complete exercise routine. Spinning accommodates everyone's individual needs and abilities. (UC Credit Limitation/CSU, AA GE, CSU GE)

KIN 142 C Power Training .5-1 Units

Formerly PE 156 C

Term hours: 27-54 hours activity depending on units attempted. This course is designed to provide instruction and supervision of students with individualized power training programs using free weights. It is for men and women of all ages who are interested in improving power moves using squats, dead lifts, and the bench press. (UC credit limitation/CSU, AA GE, CSU GE)

KIN 143 C Strength Training .5-1 Units

Formerly PE 159 C

Term hours: 27-54 hours activity depending on units attempted. This class is designed to provide individualized instruction and supervision of students with individualized strength training programs using Life Fitness, Universal and Olympic weights. It is for men and women of all ages who are interested in muscle toning, muscle rehabilitation, and/or weight redistribution. (UC Credit Limitation/CSU, AA GE, CSU GE)

KIN 144 C HIIT-High Intensity Interval Training .5-1 Units

Formerly PE 161 C

Term hours: 27-54 hours activity depending on units attempted. This course is designed for students to participate in a comprehensive fitness program which includes stretching, cardiovascular, and strengthening exercises with an emphasis on high intensity, short-term intervals. The exercises help develop agility, improve coordination, and increase endurance while normalizing body weight and improving muscle tone. (UC Credit Limitation/CSU, AA GE, CSU GE)

KIN 145 C Boot Camp Workout .5-1 Units

Formerly PE 168 C

Term hours: 27-54 laboratory. This course will focus on individual exercises including obstacle course, calisthenics, conditioning, weight training, aerobics, yoga, and overall fitness. (UC Credit Limitation/CSU, AA GE, CSU GE)

KIN 146 C Cardio Core .5-1 Units

Formerly PE 178 C

Term hours: 27-54 hours activity depending on units attempted. This course is designed for students to participate in a comprehensive fitness program which includes stretching and core strengthening exercises using stability balls, hand weights and tubing. The exercises help develop agility, improve coordination, and increase core body strength. (UC Credit Limitation/CSU, AA GE, CSU GE)

KIN 147 C Body Building and Development .5-1 Units

Formerly PE 182 C

Term hours: 27-54 lab hours depending on units attempted. This course includes building and developing the body through the use of progressive resistance exercises, as well as instruction in the proper techniques of power lifting. (UC Credit Limitation/CSU, AA GE, CSU GE)

KIN 148 C Total Body Fitness .5-1 Units

Formerly PE 187 C

Term hours: 24-54 hours activity depending on units attempted. This course emphasizes physical fitness for men which will be achieved through the use of resistance exercises and body building routines. (UC Credit Limitation/CSU, AA GE, CSU GE)

KIN 149 C Weight Training and Lifting .5-1 Units

Formerly PE 193 C

Term hours: 27-54 hours activity depending on units attempted. This weight training class stresses techniques of lifting that will produce muscle tone and strength. (UC Credit Limitation/CSU, AA GE, CSU GE)

KIN 159 C Fitness Testing with Exercise Prescription .5-1 Units

Formerly PE 154 C

Prerequisite: Physician's clearance required for persons age 35 or over.

Term hours: 18 lecture and 54 hours activity. This course will evaluate the fitness level of individuals by modern scientific equipment. Based on the results of a battery of tests, an exercise prescription will be developed to meet individual goals. Student progress will be evaluated with post testing. (CSU, AA GE, CSU GE)

KIN 160 C Badminton .5-1 Units

Formerly PE 105 C

Term hours: 27-54 hours activity depending on units attempted. This is a course in the fundamental skills of badminton with emphasis on position play and strategy for singles, doubles and mixed doubles. The class will include rules, etiquette, drills, and class competition. Equipment is furnished. (UC Credit Limitation/CSU, AA GE, CSU GE)

KIN 163 C Table Tennis .5-1 Units

Formerly PE 107 C

Term hours: 27-54 hours activity depending on units attempted. This course will consist of essential strokes with emphasis on the game strategies for singles and doubles play of table tennis. Rules, etiquette and tournament format will be introduced to the class. (UC Credit Limitation/CSU, AA GE, CSU GE)

KIN 164 C Bowling-Beginning .5-1 Units

Formerly PE 108 C

Term hours: 27-54 hours activity depending on units attempted. This course teaches the fundamental skills of bowling with emphasis on form, terminology and scoring. The student will have the opportunity for class competition. The class will be conducted at an off campus bowling establishment. Facility use fee required. To be paid throughout the semester at the facility. (UC Credit Limitation/CSU, AA GE, CSU GE)

KIN 165 C Bowling-Intermediate .5-1 Units

Advisory: Student should have beginner experience in bowling or have taken KIN 164 C.

Term hours: 27-54 hours activity depending on units attempted. This course teaches intermediate skills of bowling with emphasis on etiquette, terminology and equipment. The student will have the opportunity for class competition. The class will be conducted at an off campus bowling establishment. Facility use fee required. To be paid throughout the semester at the facility. (UC Credit Limitation/CSU, AA GE, CSU GE)

KIN 166 C Bowling-Advanced .5-1 Units

Advisory: Student should have intermediate experience in bowling or have taken KIN 165 C.

Term hours: 27-54 hours activity depending on units attempted. This course teaches advanced skills of bowling with emphasis on form, rules, and etiquette. The student will have the opportunity for class competition. The class will be conducted at an off campus bowling establishment. Facility use fee required. To be paid throughout the semester at the facility. (UC Credit Limitation/CSU, AA GE, CSU GE)

KIN 167 C Gymnastics-Tumbling .5-1 Units

Formerly PE 119 C

Term hours: 27-54 hours activity depending on units attempted. This course is designed to give the student concentrated instruction and practice in the skills of tumbling, floor exercises, and vaulting skills. (UC Credit Limitation/CSU, AA GE, CSU GE)

KIN 168 C Tennis-Beginning .5-1 Units

Formerly PE 139 C

Term hours: 27-54 hours activity depending on units attempted. The course will place emphasis on tennis fundamentals including forehand, backhand, and the serve. The course also includes rules, court strategy, and etiquette of singles and doubles play. Tournaments will be conducted during class sessions. Students must provide their own equipment. (UC Credit Limitation/CSU, AA GE, CSU GE)

KIN 169 C Tennis-Intermediate .5-1 Units

Formerly PE 141 C

Advisory: Student should have beginner experience in tennis or have taken KIN 168 C.

Term hours: 27-54 hours activity depending on units attempted. This class is designed for students desiring instruction from intermediate to advanced tennis. The class provides the opportunity to put techniques into practice through placement in the various levels of tennis ability. (UC Credit Limitation/CSU, AA GE, CSU GE)

KIN 170 C Tennis-Advanced .5-1 Units

Advisory: Student should have intermediate experience in tennis or have taken KIN 169 C.

Term hours: 27-54 hours activity depending on units attempted. This course is designed to help the advanced tennis student improve specific skills and strategies in competitive game situations. (UC Credit Limitation/CSU, AA GE, CSU GE)

KIN 171 C Golf-Beginning .5-1 Units

Formerly PE 115 C

Term hours: 27-54 hours activity depending on units attempted. This course emphasizes the basic fundamentals of golf, including rules, etiquette and terminology. Golfing activity will be held at an on-campus location for the first half of the class. The second half of the class will be held at an off-campus golf facility. Facility use fee required. To be paid throughout the semester at the facility. (UC Credit Limitation/CSU, AA GE, CSU GE)

KIN 172 C Golf-Intermediate .5-1 Units

Formerly PE 157 C

Advisory: Student should have beginner experience in golf or have taken KIN 171 C.

Term hours: 27-54 hours activity depending on units attempted. This course will emphasize advanced golf techniques and playing strategies. The class will provide advanced and low handicap golfers the opportunity to enhance their skills and techniques in execution of golf scoring strategies. Facility use fee required. To be paid throughout the semester at the facility. (UC Credit Limitation/CSU, AA GE, CSU GE)

KIN 173 C Golf-Advanced .5-1 Units

Advisory: Student should have intermediate experience in golf or have taken KIN 172 C.

Term hours: 27-54 hours. This course provides training for those seeking improvement in their golf technique and knowledge. Emphasis is on developing ball-striking skills, and on scorecard evaluation, strategy, course management, and proper application of the rules of golf. Students are responsible for balls, golf clubs, and range fees. (UC Credit Limitation/CSU, AA GE, CSU GE)

KIN 180 C Futsal-Indoor Soccer .5-1 Units

Formerly PE 109 C

Term hours: 27-54 hours activity depending on units attempted. The class will provide instruction and practice in the techniques of futsal (indoor soccer). This course will develop skills, provide knowledge of the rules and teach students to analyze techniques, solve tactical problems and improve physical fitness. (UC Credit Limitation/CSU, AA GE, CSU GE)

KIN 181 C Futsal-Intermediate .5-1 Units

Advisory: KIN 180 C.

Term Hours: 27-54 lab hours depending on units attempted. This course is designed to strengthen fundamental soccer skills. Emphasis is on scrimmages and applying offensive and defensive group strategies in competitive play. The course also introduces tactical strategies for each player: forwards, midfielders, fullbacks, and goalkeepers. (UC Credit Limitation/CSU, AA GE, CSU GE)

KIN 182 C Futsal-Advanced .5-1 Units

Advisory: Students should have intermediate soccer skill or have taken KIN 181 C.

Term Hours: 27-54 lab hours depending on units attempted. This course is designed for players who have mastered the fundamental skills, strategies, and rules of soccer and seek to develop advanced-level physical and mental skills for competitive play. In addition to refining offensive and defensive skills, students analyze game tactics and evaluate strategies for strengthening personal and team performance. (UC Credit Limitation/CSU, AA GE, CSU GE)

KIN 183 C Volleyball-Beginning .5-1 Units

Formerly PE 144 C

Term hours: 27-54 hours activity depending on units attempted. The course will include teaching of the basic skills of volleyball with emphasis on strategy and rules. The students will be offered the opportunity for class and interclass competition. (UC Credit Limitation/CSU, AA GE, CSU GE)

KIN 184 C Volleyball-Intermediate .5-1 Units

Formerly PE 145 C

Prerequisite: Demonstrate ability of basic volleyball skills.

Advisory: KIN 183 C.

Term hours: 27-54 hours activity depending on units attempted. This course is designed to provide intermediate skill development and strategies of volleyball. This class will provide intermediate players an opportunity to practice competitive techniques in games situations. (UC Credit Limitation/CSU, AA GE, CSU GE)

KIN 185 C Volleyball-Advanced .5-1 Units

Advisory: KIN 184 C.

Term hours: 27-54 lab hours depending on units attempted. This course presents advanced volleyball techniques and tactics for team and tournament play. The course offers advanced skills, court positioning, defensive techniques, and team strategy, both offensive and defensive. (UC Credit Limitation/CSU, AA GE, CSU GE)

KIN 186 C Beach Volleyball-Beginning .5-1 Units

Formerly PE 126 C

Term hours: 27-54 laboratory hours. This course provides basic instruction and strategies in beach volleyball. Designed to develop basic skills, knowledge of rules, team strategies and desire for future participation during leisure times. Course may be taken one time for credit. (UC Credit Limitation/CSU, AA GE, CSU GE)

KIN 187 C Beach Volleyball-Intermediate .5-1 Units

Formerly PE 128 C

Advisory: Student should have beginning beach volleyball skill or have taken KIN 186 C.

Term hours: 27-54 laboratory. This course provides instruction, strategies and practice of skills in beach volleyball. The course is designed to develop intermediate skills, knowledge of rules, team strategies and desire for future participation during leisure times. The course emphasizes advanced offensive and defensive theories in competitive match situations. (UC Credit Limitation/CSU, AA GE, CSU GE)

KIN 188 C Beach Volleyball-Advanced .5-1 Units

Advisory: Student should have intermediate beach volleyball skill or have taken KIN 187 C.

Term hours: 27-54 laboratory depending on units attempted. This course provides instruction, strategies and practice of skills in beach volleyball. The course is designed to develop advanced skills, knowledge of rules, team strategies and desire for future participation during leisure times. The course emphasizes advanced offensive and defensive theories in competitive match situations. Course may be taken one time for credit. UC Credit Limitation/CSU, AA GE, CSU GE)

KIN 189 C Basketball-Beginning .5-1 Units

Formerly PE 181 C

Term hours: 27-54 hours activity depending on units attempted. This course will include instruction in the fundamental skills of basketball with an emphasis on strategy and team play. The class will include rules, drills, and team competition. Equipment is furnished. (UC Credit Limitation/CSU, AA GE, CSU GE)

KIN 190 C Basketball-Intermediate .5-1 Units

Formerly PE 160 C

Advisory: Student should have beginning basketball skill or have taken KIN 189 C.

Term hours: 27-54 hours activity depending on units attempted. This activity class stresses development of the fundamental skills of basketball. Game strategies including various offenses and defenses will be analyzed and applied through team competition. (UC Credit Limitation/CSU, AA GE, CSU GE)

KIN 191 C Basketball-Advanced .5-1 Units*Advisory: Student should have intermediate basketball skill or have taken KIN 190 C.*

Term hours: 27-54 lab hours dependent on units attempted. This course is designed for players who have mastered the fundamental skills, strategies, and rules of basketball and seek to develop advanced-level physical and mental skills for competitive play. In addition to refining offensive and defensive skills, students analyze game tactics and evaluate strategies for strengthening personal and team performance. (UC Credit Limitation/CSU, AA GE, CSU GE)

KIN 192 C Water Polo .5-1 Units

Formerly PE 146 C

Prerequisite: Demonstrate ability to swim.

Term hours: 27-54 hours activity depending on units attempted. Basic instruction will be given in the fundamental skills of water polo. Instruction will emphasize passing, shooting, dribbling, conditioning, game strategy, and terminology. The course will include aquatic drills, scrimmages, and appropriate learning activities for the intermediate and advanced water polo player. (UC Credit Limitation/CSU, AA GE, CSU GE)

KIN 193 C Soccer-Women .5-1 Units

Formerly PE 171 C

Term hours: 27-54 hours activity depending on units attempted. This class will provide instruction and practice in the techniques of soccer for women. This course will develop skills, knowledge of rules, analysis of techniques and game strategies. (UC Credit Limitation/CSU, AA GE, CSU GE)

KIN 194 C Softball .5-1 Units

Formerly PE 172 C

Term hours: 27-54 hours activity depending on units attempted. The course will emphasize basic skills of women's softball including techniques, strategies of offense and defense, rules, and terminology. (UC Credit Limitation/CSU, AA GE, CSU GE)

KIN 195 C Baseball .5-1 Units

Formerly PE 180 C

Term hours: 27-54 hours activity depending on units attempted. This class includes instruction in the fundamental skills of baseball with emphasis on techniques, game strategy, and the correct methods to play the game. The course will include drills and class competition. (UC Credit Limitation/CSU, AA GE, CSU GE)

KIN 196 C Soccer-Men .5-1 Units

Formerly PE 189 C

Term hours: 27-54 hours activity depending on units attempted. This class will provide instruction and practice in the techniques of soccer for men. This course will develop skills, knowledge of rules, analysis of techniques and game strategies. (UC Credit Limitation/CSU, AA GE, CSU GE)

KIN 197 C Flag Football .5-1 Units

Formerly PE 197 C

Term hours: 27-54 hours activity depending on units attempted. This course will include the basic fundamentals of flag and touch football. The class will emphasize rules, safety procedures and team play. (UC Credit Limitation/CSU, AA GE, CSU GE)

KIN 198 C Athletic Weight Training .5-1 Units

Formerly PE 104 C

Prerequisite: KIN 202 C or KIN 203 C or KIN 204 C or KIN 205 C or KIN 206 C or KIN 210 C or KIN 211 C or KIN 212 C or KIN 213 C or KIN 214 C or KIN 215 C or KIN 217 C or KIN 218 C or Demonstrated advanced athletic skills.

Term hours: 27-162 laboratory. This course is designed with athletes in mind, but not limited to them, to enable them to work out with a prescribed individual weight program at least three days a week. It will involve specific resistance exercises to develop parts of the body used in various types of sports activities. It will also add to the safety of the athletes by helping to prevent injuries. May be taken for credit 4 times. (UC Credit Limitation, CSU, AA GE, CSU GE)

KIN 199 C Conditioning for Athletes .5-1 Units

Formerly PE 162 C

Prerequisite: KIN 202 C or KIN 203 C or KIN 204 C or KIN 208 C or KIN 209 C or KIN 210 C or KIN 211 C or KIN 212 C or KIN 214 C or KIN 218 C or KIN 219 C or KIN 222 C or Demonstrated advanced athletic skills.

Term hours: 27-162 hours activity depending on units attempted. This course is designed for individualized instruction and practice in the areas of weight training, weight lifting, anaerobic and aerobic fitness, and flexibility for competition in various intercollegiate sports. May be taken for credit 4 times. (UC Credit Limitation/CSU, AA GE, CSU GE)

KIN 202 C Intercollegiate Baseball .5-1 Units

Formerly PE 202 C

Prerequisite: Must meet the California Community College Athletics Association (CCCCAA) eligibility requirements and pass a physical examination prior to intercollegiate competition.

Term hours: 175 activity. This course is designed for the advanced baseball player wanting to participate on the intercollegiate baseball team. In order to participate in intercollegiate athletics, students must meet the CCAA eligibility requirements and pass an athletic medical screening. Daily practice is required. May be taken for credit 4 times. (UC Credit Limitation/CSU, AA GE, CSU GE)

KIN 203 C Intercollegiate Basketball-Men .5-1 Units

Formerly PE 203 C

Prerequisite: Must meet the California Community College Athletics Association (CCCCAA) eligibility requirements and pass a physical examination prior to intercollegiate competition.

Term hours: 80-175 activity. This course is designed for the advanced basketball player wanting to participate on the intercollegiate basketball team. In order to participate in intercollegiate athletics, students must meet the CCAA eligibility requirements and pass an athletic medical screening. Daily practice is required. May be taken for credit 4 times. (UC Credit Limitation/CSU, AA GE, CSU GE)

KIN 204 C Intercollegiate Basketball-Women .5-1 Units

Formerly PE 204 C

Prerequisite: Must meet the California Community College Athletics Association (CCCCAA) eligibility requirements and pass a physical examination prior to intercollegiate competition.

Term hours: 80-175 activity. In order to participate in intercollegiate athletics, all students must enroll in one of the above classes. The most qualified student athletes will be selected to represent the college during the season. These classes satisfy the physical education graduation requirement. These sports will stress fundamentals, team/individual play, and mental and physical conditioning. Daily practice or a minimum of ten hours per week is required. May be taken for credit 4 times. (UC Credit Limitation/CSU, AA GE, CSU GE)

KIN 205 C Intercollegiate Beach Volleyball-Women .5-1 Units

Formerly PE 217 C

Prerequisite: Pass team tryouts and must meet the California Community College Athletics Association (CCCCAA) eligibility requirements and pass a physical examination prior to intercollegiate competition.

Term hours: 175 activity. In order to participate in intercollegiate athletics, all students must enroll in one of the intercollegiate classes. The most qualified student athletes will be selected to represent the college during the season. This class satisfies the physical education graduation requirement. This sport will stress fundamentals, team/individual play, and mental and physical conditioning. Daily practice of a minimum of ten hours per week is required. May be taken for credit 4 times. (UC Credit Limitation/CSU, AA GE, CSU GE)

KIN 206 C Intercollegiate Golf-Men .5-1 Units

Formerly PE 208 C

Prerequisite: Must meet the California Community College Athletics Association (CCCCAA) eligibility requirements and pass a physical examination prior to intercollegiate competition.

Term hours: 175 activity. This course is designed for the advanced golfer wanting to participate on the intercollegiate golf team. In order to participate in intercollegiate athletics, students must be able to meet the CCAA eligibility requirements and pass an athletic medical screening. Daily practice is required. May be taken for credit 4 times. (UC Credit Limitation/CSU, AA GE, CSU GE)

KIN 210 C Intercollegiate Soccer-Men .5-1 Units

Formerly PE 209 C

Prerequisite: Must meet the California Community College Athletics Association (CCCCAA) eligibility requirements and pass a physical examination prior to intercollegiate competition.

Term hours: 175 activity. This course is designed for the advanced soccer player wanting to participate on the intercollegiate soccer team. In order to participate in intercollegiate athletics, students must meet the CCAA eligibility requirements and pass an athletic medical screening. Daily practice is required. May be taken for credit 4 times. (UC Credit Limitation/CSU, AA GE, CSU GE)

KIN 211 C Intercollegiate Soccer-Women .5-1 Units

Prerequisite: Must meet the California Community College Athletics Association (CCCCAA) eligibility requirements and pass a physical examination prior to intercollegiate competition.

Term hours: 175 activity. This course is designed for the advanced soccer player wanting to participate on the intercollegiate soccer team. In order to participate in intercollegiate athletics, students must meet the CCAA eligibility requirements and pass an athletic medical screening. Daily practice is required. May be taken for credit 4 times. (UC Credit Limitation/CSU, AA GE, CSU GE)

KIN 212 C Intercollegiate Softball-Women .5-1 Units

Formerly PE 210 C

Prerequisite: Must meet the California Community College Athletics Association (CCCCAA) eligibility requirements and pass a physical examination prior to intercollegiate competition.

Term hours: 175 activity. In order to participate in intercollegiate athletics, all students must enroll in one of the above classes. The most qualified student athletes will be selected to represent the college during the season. These classes satisfy the physical education graduation requirement. These sports will stress fundamentals, team/individual play, and mental and physical conditioning. Daily practice or a minimum of ten hours per week is required. May be taken for credit 4 times. (UC Credit Limitation/CSU, AA GE, CSU GE)

KIN 213 C Intercollegiate Swimming-Men .5-1 Units

Formerly PE 211 C

Prerequisite: Must meet the California Community College Athletics Association (CCCCAA) eligibility requirements and pass a physical examination prior to intercollegiate competition.

Term hours: 175 activity. In order to participate in intercollegiate athletics, all students must enroll in one of the above classes. The most qualified student athletes will be selected to represent the college during the season. These classes satisfy the physical education graduation requirement. These sports will stress fundamentals, team/individual play, and mental and physical conditioning. Daily practice or a minimum of ten hours per week is required. May be taken for credit 4 times. (UC Credit Limitation/CSU, AA GE, CSU GE)

KIN 214 C Intercollegiate Swimming-Women .5-1 Units

Formerly PE 212 C

Prerequisite: Must meet the California Community College Athletics Association (CCCCAA) eligibility requirements and pass a physical examination prior to intercollegiate competition.

Term hours: 175 activity. In order to participate in intercollegiate athletics, all students must enroll in one of the above classes. The most qualified student athletes will be selected to represent the college during the season. These classes satisfy the physical education graduation requirement. These sports will stress fundamentals, team/individual play, and mental and physical conditioning. Daily practice or a minimum of ten hours per week is required. May be taken for credit 4 times. (UC Credit Limitation/CSU, AA GE, CSU GE)

KIN 215 C Intercollegiate Tennis .5-1 Units

Formerly PE 214 C

Prerequisite: Must meet the California Community College Athletics Association (CCCCAA) eligibility requirements and pass a physical examination prior to intercollegiate competition.

Term hours: 175 activity. This course is designed for the advanced tennis player wanting to participate on the intercollegiate tennis team. In order to participate in intercollegiate athletics, students must meet the CCAA eligibility requirements and pass an athletic medical screening. Daily practice is required. May be taken for credit 4 times. (UC Credit Limitation/CSU, AA GE, CSU GE)

KIN 217 C Intercollegiate Volleyball-Women .5-1 Units

Formerly PE 218 C

Prerequisite: Must meet the California Community College Athletics Association (CCCCAA) eligibility requirements and pass a physical examination prior to intercollegiate competition.

Term hours: 175 activity. In order to participate in intercollegiate athletics, all students must enroll in one of the above classes. The most qualified student athletes will be selected to represent the college during the season. These classes satisfy the physical education graduation requirement. These sports will stress fundamentals, team/individual play, and mental and physical conditioning. Daily practice or a minimum of ten hours per week is required. May be taken for credit 4 times. (UC Credit Limitation/CSU, AA GE, CSU GE)

KIN 218 C Intercollegiate Water Polo-Women .5-1 Units

Formerly PE 219 C

Prerequisite: Must meet the California Community College Athletics Association (CCCCAA) eligibility requirements and pass a physical examination prior to intercollegiate competition.

Term hours: 175 activity. In order to participate in intercollegiate athletics, all students must enroll in one of the above classes. The most qualified student athletes will be selected to represent the college during the season. These classes satisfy the physical education graduation requirement. These sports will stress fundamentals, team/individual play, and mental and physical conditioning. Daily practice or a minimum of ten hours per week is required. May be taken for credit 4 times. (UC Credit Limitation/CSU, AA GE, CSU GE)

KIN 222 C Intercollegiate Badminton-Women .5-1 Units

Formerly PE 222 C

Prerequisite: Must meet the California Community College Athletics Association (CCCCAA) eligibility requirements and pass a physical examination prior to intercollegiate competition.

Term hours: 175 activity. This course is designed for the advanced badminton player wanting to participate on the intercollegiate badminton team. In order to participate in intercollegiate athletics, students must meet the CCAA eligibility requirements and pass an athletic medical screening. Daily practice is required. May be taken for credit 4 times. (UC Credit Limitation/CSU, AA GE, CSU GE)

KIN 230 C Introduction to Kinesiology 3 Units

Formerly PE 252 C

Term hours: 54 lecture. Introduction and orientation to the field of Kinesiology as a profession and as an academic discipline. Explores sub-disciplines, opportunities in the field, philosophy, and scientific foundation. (UC/CSU)

KIN 231 C Elementary School Movement-Kinesiology 3 Units

Formerly PE 231 C

Term hours: 36 lecture and 54 laboratory. This course is designed to acquaint the prospective elementary school teachers with physical education programs in grades K-6. The course includes observation, visitation, and actual teaching field work at an elementary school. The campus laboratory hours include methods, skills, and activities used in teaching elementary physical education. The class is recommended for elementary education majors and recommended for recreation and physical education majors. (CSU, CSU GE)

KIN 235 C First Aid, CPR and Emergencies 3 Units

Formerly PE 235 C

Term hours: 54 lecture. This course includes the theory and implementation of the skills necessary in response to an emergency. Successful completion of the course will qualify the student for the American Red Cross "Responding to Emergencies" First Aid Certificate, Adult, Child and Infant CPR Certificates, and Automated External Defibrillation Certificate. Costs may include materials for the construction of a First Aid Kit. \$27.00 Red Cross Service Fee - Payable at Registration. (UC/CSU, CSU GE)

KIN 236 C Athletic Injuries-Prevention and Care 3 Units

Formerly PE 236 C

Term hours: 36 lecture and 54 laboratory. This course is designed for future athletic trainers, coaches, and physical therapists in the field of sports medicine. The course concentrates on the prevention, evaluation, treatment and rehabilitation of athletic injuries. Methods of taping and the use of training room equipment will also be covered. (UC/CSU)

KIN 240 C Sports Officiating 3 Units

Formerly PE 240 C

Term hours: 36 lecture and 54 hours activity. This class provides practical experience with an emphasis on knowledge and interpretation of rules of sporting events. The rules and mechanics of officiating basketball, baseball, softball, volleyball and other sports will be covered. This course can be used for recreation majors, physical education majors, and people involved in community athletic organizations. The course will also explore avenues of employment related to sports officiating. (UC/CSU)

KIN 241 C Theory of Coaching Basketball 3 Units

Formerly PE 266 C

Term hours: 36 hours lecture and 54 laboratory. This course is designed to study the various aspects of coaching basketball. The emphasis of the class will be on the theory of how to organize a basketball program activity from start to finish of a season. The development of individual/team skills both offensive and defensive and scouting and/or coaching will be examined. (UC Credit Limitation/CSU)

KIN 242 C Theory of Coaching Baseball 3 Units

Formerly PE 267 C

Term hours: 36 lecture and 54 hours activity. This course includes the study of various aspects of coaching baseball. The emphasis of the class will be on the theory of how to organize a baseball program, develop individual skills, and coach offensive and defensive team work. The lab consists of scouting and coaching baseball. (UC Credit Limitation/CSU)

KIN 244 C Human Performance 3 Units

Formerly PE 244 C

Term hours: 54 lecture. This course provides guidelines for lifetime fitness using a combined approach of exercise physiology, nutrition, and biomechanics. Students will develop a working knowledge of physiological adaptations to aerobic and anaerobic exercise, of nutritional programs to achieve and maintain ideal body weight, and of desirable lifestyle management behaviors to improve wellness and human performance. (UC/CSU, AA GE, CSU GE)

KIN 247 C Sports Management 3 Units

Formerly PE 247 C

Term hours: 36 lecture and 54 hours activity. This course consists of how to organize, manage, plan, staff, direct, and control a sports program. The course also includes such areas as budget, facilities, scheduling, officials, transportation, public relations, parent and booster clubs, purchase and care of athletic equipment, fund raising, and marketing. (CSU)

KIN 248 C Psychology of Sport 3 Units

Formerly PE 248 C

Term hours: 54 lecture. This course consists of the psychological study of athletes on all levels of competition. The course includes such areas as competition, understanding coaches, goal setting, motivation, youth sports, anxiety and stress, relaxation and sport imagery, relationships, and drug abuse in sports. (CSU)

KIN 249 C Sport and United States Society 3 Units

Formerly PE 250 C

Term hours: 54 lecture. This course examines sport in the United States society and how various ethnic and under-represented groups have influenced sport participation at the local, state, and national levels. Influences of other cultures outside of the United States will be reviewed and analyzed. Media influences on the perception of sport in society will be examined. (CSU, CSU GE, CUL DIV)

KIN 255 C Lifeguarding 1 Unit

Formerly PE 237 C

Prerequisite: A minimum of 15 years of age, the ability to swim continuously 500 yards and complete a 7 to 10 feet surface dive.

Term hours: 18 lecture and 18 laboratory. This course is designed to develop and perfect the basic swimming strokes needed to successfully execute the various lifesaving skills. Upon completion of the class a student who successfully passes the written and practical exams will be qualified to be certified for an American Red Cross Lifeguard Training, First Aid, and CPR for the Professional Rescuer. \$35.00 Material Fee - PAYABLE AT REGISTRATION. (UC/CSU, CSU GE)

KIN 256 C Water Safety Instruction 2 Units

Formerly PE 238 C

Prerequisite: 16 years of age minimum, American Red Cross precourse written and skills tests. Advisory: Competency in swimming, diving, and water safety skills.

Term hours: 18 lecture and 54 laboratory. This American Red Cross course will prepare instructor candidates to teach a variety of American Red Cross swimming and water safety courses to people of all ages. Upon satisfactory completion, the students will receive an American Red Cross Water Safety Instructor certificate. This class does not meet the requirements for P.E. activity classes. \$52.00 Material Fee - PAYABLE AT REGISTRATION. (UC/CSU)

KIN 270 C Nutrition Science and Application  **3 Units**

Term hours: 54 lecture. In addition to the broad overview of the science of nutrition, this course provides information for those interested in sport performance and enhancement. Part of Fitness Specialist Certificate Program. (UC Credit Limitation/CSU, AA GE, CSU GE)

KIN 271 C Movement Anatomy  **3 Units**

Term hours: 54 lecture. This course, part of the Fitness Specialist Certificate Program, discusses movement as it relates to exercise and sports. The course examines the composition, structure, function and movements of bones and joints; the structure and actions of skeletal muscle; and the practical application of kinesiological principles in developing structurally sound exercise program. (CSU)

KIN 272 C Strength and Conditioning  **3 Units**

Term hours: 54 lecture. This course, part of the Fitness Specialist Certificate Program, provides a thorough review of the structure, action and performance of skeletal muscle for those intending to teach strength training. The course studies anatomy and physiology; muscular strength and endurance; flexibility; training sequences; available equipment; and safety factors, including contraindications. (CSU)

KIN 273 C Exercise Physiology  **3 Units**

Term hours: 54 lecture. This course, part of the Fitness Specialist Certificate Program, examines how the body functions under conditions of exercise stress. Students will study the practical implications of muscle function, cardiorespiratory and hormonal function; metabolism; body composition, training techniques; and the influence of the environment on exercise. (CSU)

KIN 274 C Exercise Testing and Prescription  **3 Units**

Term hours: 36 lecture and 54 laboratory. This course, a part of the Fitness Specialist Certificate Program, is a survey of health-related assessment tests and exercise prescription. Study of the application of exercise guidelines for apparently healthy adults based upon the standards of the American Heart Association and the American College of Sports Medicine. (CSU)

KIN 280 C Introduction to Public Health  **3 Units**

Term hours: 54 lecture. This course provides an introduction to the discipline of public health. Students will gain an understanding of the basic concepts and terminologies of public health, and the history and accomplishments of public health officials and agencies. An overview of the functions of various public health professions and institutions, and an in-depth examination of the core public health disciplines is covered. Topics of the discipline include the epidemiology of infectious and chronic disease; prevention and control of diseases in the community including the analysis of the social determinants of health and strategies for eliminating disease, illness and health disparities among various populations; community organizing and health promotion programming; environmental health and safety; global health; and healthcare policy and management. (UC/CSU, AA GE, CSU GE, IGETC, C-ID: PHS 101)

KIN 281 C Health and Social Justice  **3 Units**

Term Hours: 54 hours lecture. This course provides an introduction to the health inequities in the United States that stem from unequal living conditions. Students will explore how education, socioeconomic status, racism and gender shape health epidemics and policy development. Fundamental theories to advocate for health and social justice will be presented. (UC/CSU, AA GE, CSU GE, IGETC, CUL DIV, C-ID: PHS 102)

KIN 283 C Women's Health  **3 Units**

Term Hours: 54 lecture. This course investigates a variety of topics that concern women's health. These include the effect of lifestyle on health; the role of exercise and nutrition in promoting wellness; risk factors for cardiovascular disease, chronic diseases, and cancer; social influences and work trends that affect women; abusive behaviors, sexual harassment, and substance abuse; sexual and reproductive health; and the aging process. Students analyze theoretical and practical information to make healthy lifestyle choices. (CSU, AA GE, CSU GE)

KIN 284 C Contemporary Personal Health **.5-1 Units**

Formerly PE 234 C

Term hours: 54 lecture. This class explores advances in the medical service field as they relate to personal health and dispels myths and misconceptions. Health issues that will be covered in the course are stress management, substance abuse, alcoholism, smoking as an addiction, sexuality, marriage, birth, sexually transmitted diseases, nutrition, cancer, aging and death, and obesity. (UC/CSU, AA GE, CSU GE)

KIN 285 C Global and Community Health  **3 Units**

Term Hours: 54 lecture. This course explores the primary determinants of global health, inequalities in health status among nations, and current challenges, controversies and public policy priorities. (UC/CSU, AA GE, CSU GE, IGETC)

KIN 298 C Kinesiology Seminar **.5-12 Units**

Formerly PE 298 C

Prerequisite: May be required.

Corequisite: May be required.

Advisory: May be required.

Term hours: 9-216 lecture and/or 45-1080 laboratory depending on units attempted. This class will utilize a lecture/lab activity approach to various topics in Kinesiology. A variety of classes will be offered in order to introduce students to new experiences in the field. Pass/No Pass or Pass/No Pass/Letter Grade Option or Standard Letter Grade. Fee: May be required - Payable at Registration. (UC Credit Limitation/CSU)

KIN 299 C Kinesiology-Independent Study **.5-2 Units**

Formerly PE 299 C

Prerequisite: Approved Independent Study Learning Contract.

Term hours: A maximum of 108 hours depending on units attempted. This course is designed for students who wish to gain experience in teaching physical education classes or to increase knowledge and experience in applied areas of Kinesiology. Students must obtain permission from instructor of subject area they will be working with and will be under direct supervision of that instructor. This course does not meet requirements of physical education activity classes. (UC Credit Limitation/CSU)

Latin American Studies

LATIN AMERICAN STUDIES TRANSFER PROGRAM

Students should consult a counselor or www.assist.org for lower division major requirements for most California public universities. (See the Standard Definitions section of the catalog for a description of ASSIST.) Students transferring to an independent college/university should consult the catalog of the individual school and a counselor for lower division major requirements.

Law Enforcement — See Administration of Justice (AJ)

Liberal Studies

TRANSFER PROGRAM

Students should consult a counselor or www.assist.org for lower division major requirements for most California public universities. (See the Standard Definitions section of the catalog for a description of ASSIST.) Students transferring to an independent college/university should consult the catalog of the individual school and a counselor for lower division major requirements.

Multiple Subject Matter Program

A Multiple Subject Credential is required to teach elementary school in California. Before entering a Multiple Subject Credential Program a student must either earn a Bachelor Degree and pass the Multiple Subjects Assessment for Teachers or complete a Bachelor Degree that includes an approved Multiple Subject Matter Program that meets the seven areas prescribed by the Commission on Teacher Credentialing. Students should see a counselor for assistance in choosing appropriate classes to meet specific university requirements.

NOTE: Students, please see the Associate In Arts In Elementary Teacher Education for Transfer, (AA-T) listed under Education.

Library

Division of Library and Learning Resource Centers

Division Dean — Treisa Cassens

Faculty

Angela Boyd
Monica Doman
Leslie Palmer
William Pashaie
Joyce Peacock

Counselors

Therese Mosqueda-Ponce
Daniel Pelletier

Library (LIB)

LIB 100 C Introduction to Research

1 Unit

Term hours: 18 lecture. This class is designed to introduce students to traditional and electronic library research tools and resources including the Internet. Students learn how to develop research strategies that will enable them to locate, retrieve, analyze, evaluate, and cite appropriate resources on a given topic. Each student will compile and prepare a written bibliography of relevant sources on a topic. Pass/No Pass/Letter Grade Option. (UC/CSU)

Management

Division of Business and Computer Information Systems

Division Dean — Henry Hua

Faculty

Kathleen Pinckard

Counselor

Robert Grantham

PROGRAM LEARNING OUTCOMES (PLOs)

Management

A student who completes the management field of study will be able to:

- Understand how organizations operate and what it takes to succeed as a manager, acquiring the leadership knowledge and skills to carry out administrative functions in the key areas of management, communications, finance, and law.
- Enhance his/her employment opportunity in the specific area of management.

ASSOCIATE IN SCIENCE IN BUSINESS ADMINISTRATION FOR TRANSFER DEGREE (AS-T) Program Code: 1S31295

This curriculum is designed to provide an opportunity for the Business Administration major to achieve an Associate in Science in Business Administration for Transfer Degree (AS-T in Business Administration) which completes the first and second year requirements for transfer into the CSU system.

Advanced degrees and/or professional certificates, such as a baccalaureate degree, are required for those considering professional careers. Completion of this curriculum will demonstrate a commitment to the field and provide comprehensive preparation for further academic study through upper-division course work. This curriculum specifically prepares the prospective transfer student for upper division course work in Business Administration or a similar major at a California State University (CSU) campus. Students should consult a counselor, the Transfer Center and the catalog of the transfer college or university to plan a specific program of study to meet the college or university's requirements. Note: Courses that fulfill major requirements for an Associate Degree for Transfer at Cypress College might not be the same as those required for completing the major at all transfer institutions offering a Baccalaureate Degree.

The Student Transfer Achievement Reform Act (Senate Bill 1440, now codified in California Education Code sections 66746–66749) guarantees admission to a California State University (CSU) campus for any community college student who completes an “associate degree for transfer,” a newly established variation of the associate degrees traditionally offered at a California community college. The AS-T is intended for students who plan to complete a bachelor's degree in a similar major at a CSU campus. Students completing these degrees (AS-T) are guaranteed admission to the CSU system, but not to a particular campus or major. Students transferring to a CSU campus that does accept the AS-T will be required to complete no more than 60 units after transfer to earn a bachelor's degree (unless the major is designated “high-unit” major). This degree may not be the best option for students intending

to transfer to a particular CSU campus or to a university or college that is not part of the CSU system. Students should consult with a counselor when planning to complete the degree for more information on university admission and transfer requirements.

Students successfully completing the AS-T in Business Administration will gain knowledge in accounting, business communications, information technologies, finance, law, management, and marketing. Because business is such a broad field with many emphases and majors, this degree will provide the student a broad overview of the possible fields of study in various business areas.

To earn an AS-T in Business Administration students must complete the following requirements: (1) a minimum of 27 semester units or 40.5 quarter units in the Business Administration major with a minimum grade of "C"; (2) California State University General Education Breadth requirements (CSU GE Breadth) or the Intersegmental General Education Transfer Curriculum (CSU IGETC); (3) elective courses to complete a minimum of 60 units of CSU transferable course work; (4) have an overall GPA of 2.0.

Required Core Courses are listed in suggested sequence. (17 units)

| | Units |
|------------|-------|
| ACCT 101 C | 4 |
| ACCT 102 C | 4 |
| ECON 100 C | 3 |
| | |
| ECON 100HC | (3) |
| ECON 105 C | 3 |
| | |
| ECON 105HC | (3) |
| MGT 240 C | 3 |

List A: Select one of the following: (4 units)

| | Units |
|------------|-------|
| MATH 130 C | 4 |
| MATH 120 C | 4 |
| MATH 115 C | 4 |

List B: Select two of the following or any courses from List A not already chosen. (6–8 units)

| | Units |
|-----------------------------|--------------|
| CIS 111 C | 3 |
| MGT 161 C | 3 |
| | |
| MGT 211 C | (3) |
| Total Units Required | 27–29 |

*A score of 3 or higher on the Advanced Placement (AP) Economics (macro) exam meets this requirement upon petition through Admissions and Records. See a counselor for more information.

**A score of 3 or higher on the Advanced Placement (AP) Economics (micro) exam meets this requirement upon petition through Admissions and Records. See a counselor for more information.

ASSOCIATE IN SCIENCE DEGREE BUSINESS MANAGEMENT Program Code: 1S03762

This curriculum is designed to prepare students for careers in the administration of modern organizations. Focusing on the ways that businesses operate and what it takes to succeed as a manager, the program covers such areas as management, marketing, law, accounting, economics, and the global environment.

To earn an Associate Degree students must complete: (1) all major course requirements with a minimum grade of "C"; (2) 25 units of General Education Graduation Requirements; (3) the cultural diversity and reading requirements; (4) any elective courses to complete a minimum of 60 units; and, (5) have a minimum GPA of 2.0. At least 50% of all major course work must be completed at Cypress College.

Courses that fulfill major requirements for an Associate Degree at Cypress College might not be the same as those required for completing the major at a transfer institution offering a Baccalaureate Degree. For information on specific university requirements, please consult with your counselor, or visit the Transfer Center.

Required courses are listed in suggested sequence:

| Course # | Title | Units |
|-----------------------------|-------------------------------------|-----------|
| MGT 161 C | Introduction to Business | 3 |
| CIS 111 C | Computer Information Systems | 3 |
| MGT 262 C | Principles of Management | 3 |
| MGT 266 C | Human Relations in Business | 3 |
| MGT 240 C | Legal Environment of Business | 3 |
| | or | |
| MGT 241 C | Legal Aspects-Business Transactions | (3) |
| ACCT 101 C | Financial Accounting | 4 |
| MKT 222 C | Principles of Marketing | 3 |
| ECON 110 C | Survey of Economics | 3 |
| | or | |
| **ECON 105 C | Principles of Economics — Micro | (3) |
| | or | |
| **ECON 105HC | Honors Principles of Economics | (3) |
| MGT 261 C | Small Business Management | 3 |
| Total Units Required | | 28 |

Additional Recommended Course Work (not required)

| | | |
|------------|-----------------------------------|---|
| MKT 205 C | Multicultural Markets in U.S. | 3 |
| MKT 208 C | Principles of Selling | 3 |
| MGT 151 C | Business Mathematics | 3 |
| ACCT 102 C | Managerial Accounting | 4 |
| MGT 111 C | Business Communications | 3 |
| MGT 269 C | Office Management | 3 |
| MGT 265 C | Social Responsibility of Business | 3 |

**A score of 3 or higher on the Advanced Placement (AP) Economics (micro) exam meets this requirement upon petition through Admissions and Records. See a counselor for more information.

BUSINESS MANAGEMENT CERTIFICATE Program Code: 1C21095

Primary emphasis is to provide students with the necessary skills to perform the various administrative duties of a manager. The program focuses on management, marketing, law, accounting, economics, and the global environment.

To earn a certificate, students must complete the required courses as listed with a minimum grade of "C." At least 50% of all course work must be completed at Cypress College.

Required courses are listed in suggested sequence:

| Course # | Title | Units |
|--------------|-------------------------------------|-----------|
| MGT 161 C | Introduction to Business | 3 |
| CIS 111 C | Computer Information Systems | 3 |
| MGT 261 C | Small Business Management | 3 |
| MGT 266 C | Human Relations in Business | 3 |
| ACCT 101 C | Financial Accounting | 4 |
| ECON 110 C | Survey of Economics | 3 |
| | or | |
| **ECON 105 C | Principles of Economics — Micro | (3) |
| | or | |
| **ECON 105HC | Honors Principles of Economics | (3) |
| MGT 240 C | Legal Environment of Business | 3 |
| | or | |
| MGT 241 C | Legal Aspects-Business Transactions | (3) |
| MGT 262 C | Principles of Management | 3 |
| MKT 222 C | Principles of Marketing | 3 |
| | Total Units Required | 28 |

**A score of 3 or higher on the Advanced Placement (AP) Economics (micro) exam meets this requirement upon petition through Admissions and Records. See a counselor for more information.

ASSOCIATE IN SCIENCE DEGREE

RETAIL MANAGEMENT

(W AFC)

Program Code: 1S12307

This curriculum is designed to prepare students to assume leadership positions in the retail sector, providing them with the essential business skills needed to perform supervisory and management duties. Created through a partnership with the Western Association of Food Chains and retailers in a variety of fields, this program will help students pursue careers in the grocery industry and others that deal directly with consumers, such as the apparel, home furnishings, general merchandise, and services industries.

To earn an Associate Degree students must complete: (1) all major course requirements with a minimum grade of “C”; (2) 25 units of General Education Graduation Requirements; (3) the cultural diversity and reading requirements; (4) any elective courses to complete a minimum of 60 units; and, (5) have a minimum GPA of 2.0. At least 50% of all major course work must be completed at Cypress College.

Courses that fulfill major requirements for an Associate Degree at Cypress College might not be the same as those required for completing the major at a transfer institution offering a Baccalaureate Degree. For information on specific university requirements, please consult with your counselor, or visit the Transfer Center.

Required courses are listed in suggested sequence:

| Course # | Title | Units |
|------------|------------------------------|-----------|
| MGT 111 C | Business Communications | 3 |
| | or | |
| MGT 211 C | Writing for Business | (3) |
| MGT 151 C | Business Mathematics | 3 |
| CIS 111 C | Computer Information Systems | 3 |
| COMM 100 C | Human Communication | 3 |
| | or | |
| COMM 100HC | Honors Human Communication | (3) |
| MGT 262 C | Principles of Management | 3 |
| ACCT 101 C | Financial Accounting | 4 |
| MKT 222 C | Principles of Marketing | 3 |
| MKT 105 C | Principles of Retailing | 3 |
| MGT 266 C | Human Relations in Business | 3 |
| MGT 268 C | Human Resources Management | 3 |
| | Total Units Required | 31 |

RETAIL MANAGEMENT (W AFC)

CERTIFICATE

Program Code: 1C21097

Primary emphasis is to provide students with the essential business skills needed to develop a successful management career in retailing. Created through a partnership with the Western Association of Food Chains and retailers in a variety of fields, this certificate will help prepare students to work in the grocery industry and others that deal directly with consumers, such as the apparel, home furnishings, general merchandise, and services industries.

To earn a certificate, students must complete the required courses as listed with a minimum grade of “C.” At least 50% of all course work must be completed at Cypress College.

Required courses are listed in suggested sequence:

| Course # | Title | Units |
|------------|------------------------------|-----------|
| MGT 111 C | Business Communications | 3 |
| | or | |
| MGT 211 C | Writing for Business | (3) |
| MGT 151 C | Business Mathematics | 3 |
| CIS 111 C | Computer Information Systems | 3 |
| COMM 100 C | Human Communication | 3 |
| | or | |
| COMM 100HC | Honors Human Communication | (3) |
| MGT 262 C | Principles of Management | 3 |
| ACCT 101 C | Financial Accounting | 4 |
| MKT 222 C | Principles of Marketing | 3 |
| MKT 105 C | Principles of Retailing | 3 |
| MGT 266 C | Human Relations in Business | 3 |
| MGT 268 C | Human Resources Management | 3 |
| | Total Units Required | 31 |

ASSOCIATE IN SCIENCE DEGREE

SMALL BUSINESS

MANAGEMENT

Program Code: 1S12296

This curriculum is designed to provide students with the necessary information and skills to start, manage, and promote a small business enterprise in today’s global environment. Focusing on the steps involved in building a business, the program covers all aspects of business ownership and the ways to develop one’s entrepreneurial abilities.

To earn an Associate Degree students must complete: (1) all major course requirements with a minimum grade of “C”; (2) 25 units of General Education Graduation Requirements; (3) the cultural diversity reading requirements; (4) any elective courses to complete a minimum of 60 units; and, (5) have a minimum GPA of 2.0. At least 50% of all major course work must be completed at Cypress College.

Courses that fulfill major requirements for an Associate Degree at Cypress College might not be the same as those required for completing the major at a transfer institution offering a Baccalaureate Degree. For information on specific university requirements, please consult with your counselor, or visit the Transfer Center.

Required courses are listed in suggested sequence:

| Course # | Title | Units |
|--|-----------------------------|-----------|
| MGT 161 C | Introduction to Business | 3 |
| MGT 261 C | Small Business Management | 3 |
| MKT 201 C | Small Business Promotion | 3 |
| MKT 222 C | Principles of Marketing | 3 |
| MKT 208 C | Principles of Selling | 3 |
| MGT 266 C | Human Relations in Business | 3 |
| ACCT 101 C | Financial Accounting | 4 |
| Select a minimum of 6 units from the elective courses listed below | | 6 |
| Total Units Required | | 28 |

Electives

| | | |
|-----------|------------------------------|---|
| MKT 103 C | Principles of Advertising | 3 |
| CIS 111 C | Computer Information Systems | 3 |
| MKT 224 C | International Marketing | 3 |
| MGT 101 C | Personal Finance | 3 |
| MKT 105 C | Principles of Retailing | 3 |
| MGT 267 C | Principles of Supervision | 3 |
| MGT 211 C | Writing for Business | 3 |

SMALL BUSINESS MANAGEMENT CERTIFICATE

Program Code: 1C21096

Primary emphasis is to provide an organized course of study that will enable students to develop their entrepreneurial skills, recognize opportunities, and learn the basics of starting and managing a small business in today's global environment.

To earn a certificate, students must complete the required courses as listed with a minimum grade of "C." At least 50% of all course work must be completed at Cypress College.

Required courses are listed in suggested sequence:

| Course # | Title | Units |
|--|-----------------------------|-----------|
| MGT 161 C | Introduction to Business | 3 |
| MGT 261 C | Small Business Management | 3 |
| MKT 201 C | Small Business Promotion | 3 |
| MKT 222 C | Principles of Marketing | 3 |
| MKT 208 C | Principles of Selling | 3 |
| MGT 266 C | Human Relations in Business | 3 |
| ACCT 101 C | Financial Accounting | 4 |
| Select a minimum of 6 units from the elective courses listed below | | 6 |
| Total Units Required | | 28 |

Electives

| | | |
|-----------|------------------------------|---|
| MKT 103 C | Principles of Advertising | 3 |
| CIS 111 C | Computer Information Systems | 3 |
| MKT 224 C | International Marketing | 3 |
| MGT 101 C | Personal Finance | 3 |
| MKT 105 C | Principles of Retailing | 3 |
| MGT 267 C | Principles of Supervision | 3 |
| MGT 211 C | Writing for Business | 3 |

BUSINESS ECONOMICS CERTIFICATE

Program Code: 1C17172

Combining economics principles with business practices, this certificate program provides students with the necessary knowledge to make informed financial decisions. Students will gain an understanding of supply and demand and resource allocation issues, marketplace competitive factors, consumer purchasing patterns, and money-management and investment strategies.

To earn a certificate, students must complete the required courses as listed with a minimum grade of "C." At least 50% of all course work must be completed at Cypress College.

Required courses are listed in suggested sequence:

| Course # | Title | Units |
|-----------------------------|---------------------------------|-----------|
| **ECON 105 C | Principles of Economics — Micro | 3 |
| or | | |
| **ECON 105HC | Honors Principles of Economics | (3) |
| MGT 161 C | Introduction to Business | 3 |
| ECON 130 C | Consumer Economics | 3 |
| or | | |
| MKT 210 C | Consumer Behavior | (3) |
| MGT 101 C | Personal Finance | 3 |
| or | | |
| MGT 102 C | Financial Literacy | (3) |
| Total Units Required | | 12 |

**A score of 3 or higher on the Advanced Placement (AP) Economics (micro) exam meets this requirement upon petition through Admissions and Records. See a counselor for more information.

COMMERCIAL MUSIC MANAGEMENT CERTIFICATE

Program Code: 1C12951

A synthesis of Music and Business courses, this certificate enables students to develop the management, marketing, and entrepreneurial skills necessary for success in the Music Industry.

To earn a certificate, students must complete the required courses as listed with a minimum grade of "C." At least 50% of all course work must be completed at Cypress College.

Required courses are listed in suggested sequence:

| Course # | Title | Units |
|-----------------------------|----------------------------------|-----------|
| MUS 111 C | The Music Business | 3 |
| MUS 212 C | Music Promotion and Distribution | 3 |
| MKT 222 C | Principles of Marketing | 3 |
| MGT 261 C | Small Business Management | 3 |
| MGT 266 C | Human Relations in Business | 3 |
| Total Units Required | | 15 |

Additional Recommended Course Work (not required)

| | | |
|-----------|-------------------------|-----|
| MKT 224 C | International Marketing | (3) |
|-----------|-------------------------|-----|

PROFESSIONAL MARKETING CERTIFICATE

Program Code: 1C31328

This certificate program provides students with a working knowledge of the marketing and sales activities required to satisfy customers' needs and wants for goods and services. Program is designed for both marketing and sales professionals and those wishing to pursue marketing careers. To earn a certificate, complete the required courses as listed with a minimum grade of "C." At least 50% of all course work must be completed at Cypress College.

Required courses are listed in suggested sequence:

| Course # | Title | Units |
|-----------------------------|--|-----------|
| MKT 090 C | Marketing Essentials | 1 |
| MKT 091 C | Advertising and Public Relations | 1 |
| MKT 092 C | Personal Selling | 1 |
| MKT 093 C | Target Marketing | .5 |
| MKT 094 C | Buyer Behavior | .5 |
| MKT 095 C | Market Distribution Systems | .5 |
| MKT 096 C | Sales Promotion Techniques | .5 |
| MKT 097 C | Customer Relations | .5 |
| MKT 098 C | International Marketing - Small Business | .5 |
| MKT 086 C | Sales Prospecting | .5 |
| MKT 087 C | Sales Presentations | .5 |
| MKT 088 C | Handling Sales Objections | .5 |
| MKT 089 C | Making the Sale | .5 |
| MGT 085 C | Business Planning | 1 |
| MGT 161 C | Introduction to Business | 3 |
| Total Units Required | | 12 |

PROJECT MANAGEMENT CERTIFICATE

Program Code: 1C32627

The Project Management Certificate is designed to help students: (A) Understand the role and functions of the project manager; (B) Plan and manage projects using Microsoft Project software, Work Breakdown Structures, Gantt charts, and PERT charts; (C) Manage project time, budget, and project team more effectively; (D) Apply these tools immediately by completing a project plan and budget as part of the course of study.

| Course # | Title | Units |
|-----------|---------------------------------|-----------|
| CIS 274 C | Project Management Fundamentals | 3 |
| CIS 216 C | Microsoft Project | 3 |
| MKT 222 C | Principles of Marketing | 3 |
| MGT 262 C | Principles of Management | 3 |
| | or | |
| MGT 266 C | Human Relations in Business | (3) |
| | Total Units Required | 12 |

SMALL BUSINESS OPERATIONS CERTIFICATE

Program Code: 1C31342

This certificate program provides students with information on the various steps and management and marketing decisions involved in starting and operating a business. Program is designed for both prospective and current business owners.

To earn a certificate, students must complete the required courses as listed with a minimum grade of "C." At least 50% of all course work must be completed at Cypress College.

Required courses are listed in suggested sequence:

| Course # | Title | Units |
|-----------|--|-----------|
| MGT 085 C | Business Planning | 1 |
| MGT 086 C | Business Finance-Recordkeeping | .5 |
| MGT 087 C | Computer Technology for Small Business | .5 |
| MGT 088 C | Managing Personnel | .5 |
| MGT 089 C | Business Law - Small Business | .5 |
| MKT 090 C | Marketing Essentials | 1 |
| MKT 091 C | Advertising and Public Relations | 1 |
| MKT 092 C | Personal Selling | 1 |
| MKT 093 C | Target Marketing | .5 |
| MKT 094 C | Buyer Behavior | .5 |
| MKT 095 C | Market Distribution Systems | .5 |
| MKT 096 C | Sales Promotion Techniques | .5 |
| MKT 097 C | Customer Relations | .5 |
| MKT 098 C | International Marketing - Small Business | .5 |
| MGT 161 C | Introduction to Business | 3 |
| | Total Units Required | 12 |

MANAGEMENT TRANSFER PROGRAM

Refer to Catalog under:

BUSINESS ADMINISTRATION TRANSFER PROGRAM

Students should consult a counselor or www.assist.org for lower division major requirements for most California public universities. (See the Standard Definitions section of the catalog for a description of ASSIST.) Students transferring to an independent college/university should consult the catalog of the individual school and a counselor for lower division major requirements.

Management (MGT)

CONSUMER RELATIONS

MGT 101 C Personal Finance **3 Units**

Term hours: 54 lecture. This course focuses on the management of personal income and expenses through effective financial planning, budgeting and investing, showing students how to improve their standard of living and build wealth. Pass/No Pass/Letter Grade Option. (CSU)

ENGLISH-RELATED COURSES

MGT 055 C Business English **3 Units**

Term hours: 54 lecture. This course includes instruction in techniques of basic grammar, punctuation, vocabulary, spelling, and capitalization. The emphasis is on grammar as used in business communications.

MGT 111 C Business Communications **3 Units**

Prerequisite: MGT 055 C.

Term hours: 54 lecture. The course includes instruction in the techniques of specific types of business communication media and in the general principles of effective communication. The elements and principles of written and spoken communications are covered with emphasis on the kind of writing and speaking that is conducted throughout a business career. The importance of communication is stressed. Applying skill and ingenuity in the use of the language is encouraged. Credit by Examination. (CSU)

MGT 211 C Writing for Business **3 Units**

Prerequisite: ENGL 100 C with a grade of "C" or better.

Term hours: 54 lecture. This course is an introduction to the communication skills and knowledge needed in today's organizations. It focuses on the writing process and communication fundamentals; ethical, legal, and multicultural issues; correspondence; employment communication; report writing; presentations; research methods; oral and nonverbal communication and ways to run effective meetings and conferences. Includes computer applications throughout the course. (CSU, C-ID: BUS 115)

MATH-RELATED COURSES

MGT 151 C Business Mathematics **3 Units**

Term hours: 54 lecture. This course is an introduction to the fundamental operation of arithmetic as applied to business problems. Included are problems in simple and compound interest; bank and purchase discounts, payroll computations, sales and property taxes, depreciation, business financial statements, and distribution of ownership and profits. (CSU, AA GE)

ORGANIZATION/PERSONNEL/ MANAGEMENT-RELATED COURSES

MGT 085 C Business Planning **1 Unit**

Term hours: 18 lecture. This course is designed for both prospective and current entrepreneurs. It focuses on the steps involved in starting a business, including choosing the type of business and location, financial and legal considerations, and marketing and management strategies. Participants will receive guidance in preparing a complete business plan. Pass/No Pass only.

MGT 086 C Business Finance-Recordkeeping .5 Units

Term hours: 9 lecture. Course addresses financial start-up needs for entrepreneurs, sources and uses of funds, bookkeeping, financial statements and tax reporting. Pass/No Pass only.

MGT 087 C Computer Technology for Small Business .5 Units

Term hours: 9 lecture. This course explains how to use computers and the Internet to run a small business and utilize social media. Pass/No Pass only.

MGT 088 C Managing Personnel .5 Units

Term hours: 9 lecture. This course focuses on techniques for the recruitment, training, compensation, management and motivation of workers in the business enterprise. Pass/No Pass only.

MGT 089 C Business Law - Small Business .5 Units

Term hours: 9 lecture. This course covers the key legal issues facing small businesses: choosing a legal form, licenses and permits, contracts, liability, agency/principal relationships, and government regulations. Pass/No Pass only.

MGT 102 C Financial Literacy 3 Units

Term hours: 54 lecture. This course is designed to provide students with the general financial knowledge and skills needed to take responsibility for their economic security, enabling students to make informed decisions to manage their money, build wealth, and protect assets. Pass/No Pass/Letter Grade Option. (CSU)

MGT 161 C Introduction to Business 3 Units

Term hours: 54 lecture. This course provides a survey of the principles and practices of American businesses in a global environment. Subject areas include business organization structure, management, human relations, marketing, accounting, finance, small business operations, and international business. Pass/No Pass/Letter Grade Option. (UC/CSU, AA GE, CSU GE, C-ID: BUS 110)

MGT 199 C Management Independent Study .5 to 2 Units

Prerequisite: Approved Independent Study Learning Contract.

Term hours: The number of hours of scheduled conferences or activity per week will be determined by the instructor. This course is designed for students who wish to gain experience in management activities or to increase knowledge and experience in applied areas of leadership. Students must obtain permission from instructor of subject area they will be working with and will be under direct supervision of that instructor. This course does not meet requirements of management classes. (CSU)

MGT 261 C Small Business Management 3 Units

Term hours: 54 lecture. This course applies principles of management to small business enterprises, focusing on planning and start-up, financing, legal form, staffing, location and site evaluation, marketing, and franchising. Pass/No Pass/Letter Grade Option. (CSU)

MGT 262 C Principles of Management 3 Units

Term hours: 54 lecture. This course focuses on the responsibilities and roles of managers, the types of decisions they make, and the steps involved in the management process. The major areas of study include the basic management functions of planning, organizing, directing, and controlling work activities. Pass/No Pass/Letter Grade Option. (CSU)

MGT 265 C Social Responsibility of Business 3 Units

Term hours: 54 lecture. This course addresses the social responsibilities of businesses beyond making profits, focusing on their obligations to society, their communities, the natural environment, and other groups. The emphasis is on building positive relationships, managing natural resources in sustainable and non-polluting ways, and being responsive and accountable for their actions. Pass/No Pass/Letter Grade Option. (CSU)

MGT 266 C Human Relations in Business 3 Units

Term hours: 54 lecture. This course provides an introduction to the principles of human behavior and relationships in modern organizations. The emphasis is placed on leadership theory, communication, motivation, team-building and the development of a productive work environment. Pass/No Pass/Letter Grade Option. (CSU, AA GE)

MGT 267 C Principles of Supervision 3 Units

Term hours: 54 lecture. This course presents the fundamental techniques a supervisor needs to know about motivating people, managing a job, and the development of situational leadership styles. (CSU)

MGT 268 C Human Resources Management 3 Units

Term hours: 54 lecture. This course provides theories and practices relating to personal administration, labor-management relations, employee selection, training, performance appraisal, discharge, hours of work and methods of payment, handling of personnel problems, benefit programs, affirmative action, and equal employment. (CSU)

MGT 295 C Management Internship 1 to 4 Units

Term hours: 18-72 lecture depending on units attempted. This course is designed to give the student credit for work experience at a related occupational worksite, while being concurrently enrolled in a vocational major. For each unit of credit, a minimum of 75 paid or 60 unpaid worksite internship hours is required. The internship allows students to apply knowledge gained in college courses to an actual work setting, sample career choices and improve job-readiness skills. Supplemental reading and course assignments required. May be taken for credit 4 times. Open Entry/Open Exit. Pass/No Pass/Letter Grade Option. (CSU)

LAW-RELATED COURSES**MGT 143 C Introduction to Legal Research 1 Unit**

Term hours: 18 lecture. This course provides an introduction to the nature and use of legal reference material with consideration given to a uniform system of citation. An exposure to legal reference material will include constitutions, statutes and codes, executive orders, administrative agency regulations and rulings, treaties, judicial reports, indexes, digests, citators, treatises, looseleaf services, periodicals, encyclopedias, procedure manuals, and form books. Pass/No Pass/Letter Grade Option. (CSU)

MGT 240 C Legal Environment of Business 3 Units

Term hours: 54 lecture. This course is an introduction to the legal environment in which a business firm operates. Topics include an introduction to the American legal system, contracts, torts, product liability, forms of business organization, trade regulation, labor law and diversity issues, environmental law, and international business law. Pass/No Pass/Letter Grade Option. (CSU, C-ID: BUS 120)

Marketing

Division of Business and Computer Information Systems

Division Dean — Henry Hua

Faculty

Kathleen Pinckard

Counselor

Robert Grantham

PROGRAM LEARNING OUTCOMES (PLOs)

Marketing

A student who completes the marketing field of study will be able to:

- Understand the various marketing functions (product development, pricing, promotion, and distribution) and how organizations utilize these to produce goods and services that satisfy the needs and wants of consumers.
- Enhance his/her employment opportunity in the specific area of marketing.

ASSOCIATE IN SCIENCE IN BUSINESS ADMINISTRATION FOR TRANSFER DEGREE (AS-T)

Program Code: 1S31295

This curriculum is designed to provide an opportunity for the Business Administration major to achieve an Associate in Science in Business Administration for Transfer Degree (AS-T in Business Administration) which completes the first and second year requirements for transfer into the CSU system.

Advanced degrees and/or professional certificates, such as a baccalaureate degree, are required for those considering professional careers. Completion of this curriculum will demonstrate a commitment to the field and provide comprehensive preparation for further academic study through upper-division course work. This curriculum specifically prepares the prospective transfer student for upper division course work in Business Administration or a similar major at a California State University (CSU) campus. Students should consult a counselor, the Transfer Center and the catalog of the transfer college or university to plan a specific program of study to meet the college or university's requirements. Note: Courses that fulfill major requirements for an Associate Degree for Transfer at Cypress College might not be the same as those required for completing the major at all transfer institutions offering a Baccalaureate Degree.

The Student Transfer Achievement Reform Act (Senate Bill 1440, now codified in California Education Code sections 66746–66749) guarantees admission to a California State University (CSU) campus for any community college student who completes an “associate degree for transfer,” a newly established variation of the associate degrees traditionally offered at a California community college. The AS-T is intended for students who plan to complete a bachelor’s degree in a similar major at a CSU campus. Students completing these degrees (AS-T) are guaranteed admission to the CSU system, but not to a particular campus or major. Students transferring to a CSU campus that does accept the AS-T will be required to complete no more than 60 units after transfer to earn a bachelor’s degree (unless the major is designated “high-unit” major). This degree may not be the best option for students intending to transfer to a particular CSU campus or to a university or college that is not part of the CSU system. Students should consult with a counselor when planning to complete the degree for more information on university admission and transfer requirements.

Students successfully completing the AS-T in Business Administration will gain knowledge in accounting, business communications, information technologies, finance, law, management, and marketing. Because business is such a broad field with many emphases and majors, this degree will provide the student a broad overview of the possible fields of study in various business areas.

To earn an AS-T in Business Administration students must complete the following requirements: (1) a minimum of 27–29 semester units or 40.5–43.5 quarter units in the Business Administration major with a minimum grade of “C”; (2) California State University General Education Breadth requirements (CSU GE Breadth) or the Intersegmental General Education Transfer Curriculum (CSU IGETC); (3) elective courses to complete a minimum of 60 units of CSU transferable course work; (4) have an overall GPA of 2.0.

Required Core Courses are listed in suggested sequence.

| (17 units) | | Units |
|-------------------|---------------------------------|--------------|
| ACCT 101 C | Financial Accounting | 4 |
| ACCT 102 C | Managerial Accounting | 4 |
| ECON 100 C | Principles of Economics — Macro | 3 |
| | or | |
| ECON 100HC | Honors Principles of Economics | (3) |
| ECON 105 C | Principles of Economics — Micro | 3 |
| | or | |
| ECON 105HC | Honors Principles of Economics | (3) |
| MGT 240 C | Legal Environment of Business | 3 |

| List A: Select one of the following: (4 units) | | Units |
|---|--|--------------|
| MATH 130 C | Survey of Calculus | 4 |
| MATH 120 C | Introduction to Probability and Statistics | 4 |
| MATH 115 C | Finite Mathematics | 4 |

| List B: Select two of the following or any courses from List A not already chosen. (6–8 units) | | Units |
|---|------------------------------|--------------|
| CIS 111 C | Computer Information Systems | 3 |
| MGT 161 C | Introduction to Business | 3 |
| | or | |
| MGT 211 C | Writing for Business | (3) |
| Total Units Required | | 27–29 |

ASSOCIATE IN SCIENCE DEGREE**MARKETING****Program Code: 1S03764**

This curriculum is designed to prepare students for careers in marketing — performing the activities that enable businesses to satisfy customers' needs and wants. Students will learn product development, pricing, promotion, and distribution methods while gaining skills in selling, retailing, advertising, market researching, and other marketing areas.

To earn an Associate Degree students must complete: (1) all major course requirements with a minimum grade of "C"; (2) 25 units of General Education Graduation Requirements; (3) the cultural diversity and reading requirements; (4) any elective courses to complete a minimum of 60 units; and, (5) have minimum GPA of 2.0. At least 50% of all major course work must be completed at Cypress College.

Courses that fulfill major requirements for an Associate Degree at Cypress College might not be the same as those required for completing the major at a transfer institution offering a Baccalaureate Degree. For information on specific university requirements, please consult with your counselor, or visit the Transfer Center.

Required courses are listed in suggested sequence:

| Course # | Title | Units |
|--|---------------------------|-----------|
| MGT 161 C | Introduction to Business | 3 |
| MKT 103 C | Principles of Advertising | 3 |
| MKT 222 C | Principles of Marketing | 3 |
| MKT 105 C | Principles of Retailing | 3 |
| MKT 208 C | Principles of Selling | 3 |
| MKT 210 C | Consumer Behavior | 3 |
| Select a minimum of 3 units from the elective courses listed below | | 3 |
| Total Units Required | | 21 |

Electives

| | | |
|------------|-------------------------------|---|
| MKT 205 C | Multicultural Markets in U.S. | 3 |
| MKT 224 C | International Marketing | 3 |
| MKT 201 C | Small Business Promotion | 3 |
| ACCT 101 C | Financial Accounting | 4 |
| MGT 151 C | Business Mathematics | 3 |

MARKETING CERTIFICATE Program Code: 1C21098

Primary emphasis is to provide students with the necessary skills to carry out the key marketing functions in a business, developing, pricing, promoting, and distributing products and services.

To earn a certificate, students must complete the required courses as listed with a minimum grade of "C." At least 50% of all course work must be completed at Cypress College.

Required courses are listed in suggested sequence:

| Course # | Title | Units |
|--|---------------------------|-----------|
| MGT 161 C | Introduction to Business | 3 |
| MKT 103 C | Principles of Advertising | 3 |
| MKT 222 C | Principles of Marketing | 3 |
| MKT 105 C | Principles of Retailing | 3 |
| MKT 208 C | Principles of Selling | 3 |
| MKT 210 C | Consumer Behavior | 3 |
| Select a minimum of 3 units from the elective courses listed below | | 3 |
| Total Units Required | | 21 |

Electives

| | | |
|------------|-------------------------------|---|
| MKT 205 C | Multicultural Markets in U.S. | 3 |
| MKT 224 C | International Marketing | 3 |
| MKT 201 C | Small Business Promotion | 3 |
| ACCT 101 C | Financial Accounting | 4 |
| MGT 151 C | Business Mathematics | 3 |

AUTOMOTIVE SALES AND SERVICE**CERTIFICATE****Program Code: 1C15688**

This program is designed to prepare students for customer service and sales positions in the automotive industry. It provides students with a basic knowledge of automobile operations, general maintenance requirements, and damage appraisal procedures along with marketing and management principles. The certificate will enable students to work in a variety of non-technical areas in an automobile dealership, repair shop, or insurance company as a service representative, salesperson, or estimator.

To earn a certificate, students must complete the required courses as listed with a minimum grade of "C." At least 50% of all course work must be completed at Cypress College.

Required courses are listed in suggested sequence:

| Course # | Title | Units |
|-----------------------------|---------------------------------------|--------------|
| AT 101 C | Survey of the Automobile | 3 |
| | or | |
| AT 110 C | Introduction to Automotive Technology | (4) |
| ACR 012 C | Collision Damage Appraisal | 3 |
| MGT 266 C | Human Relations in Business | 3 |
| MKT 222 C | Principles of Marketing | 3 |
| MKT 208 C | Principles of Selling | 3 |
| Total Units Required | | 15–16 |

GEOGRAPHIC INFORMATION SYSTEMS/**MARKETING CERTIFICATE Program Code: 1C12953**

This certificate program provides students with the skills to use Geographic Information Systems (GIS) computerized mapping techniques in the field of marketing. Combining the latest computer graphics and marketing research methods, students will learn to create maps to locate customers, evaluate business sites, plan distribution networks and sales territories, and find new business opportunities.

To earn a certificate, students must complete the required courses as listed with a minimum grade of "C." At least 50% of all course work must be completed at Cypress College.

Required courses are listed in suggested sequence:

| Course # | Title | Units |
|-----------------------------|--------------------------|-----------|
| MKT 222 C | Principles of Marketing | 3 |
| MKT 210 C | Consumer Behavior | 3 |
| MKT 224 C | International Marketing | 3 |
| GEOG 230 C | Introduction to GIS | 3 |
| GEOG 231 C | GIS: Vector Applications | 3 |
| Total Units Required | | 15 |

PROFESSIONAL MARKETING CERTIFICATE

Program Code: 1C31328

This certificate program provides students with a working knowledge of the marketing and sales activities required to satisfy customers' needs and wants for goods and services. Program is designed for both marketing and sales professionals and those wishing to pursue marketing careers.

To earn a certificate, complete the required courses as listed with a minimum grade of "C." At least 50% of all course work must be completed at Cypress College.

Required courses are listed in suggested sequence:

| Course # | Title | Units |
|-----------------------------|--|-----------|
| MKT 090 C | Marketing Essentials | 1 |
| MKT 091 C | Advertising and Public Relations | 1 |
| MKT 092 C | Personal Selling | 1 |
| MKT 093 C | Target Marketing | .5 |
| MKT 094 C | Buyer Behavior | .5 |
| MKT 095 C | Market Distribution Systems | .5 |
| MKT 096 C | Sales Promotion Techniques | .5 |
| MKT 097 C | Customer Relations | .5 |
| MKT 098 C | International Marketing - Small Business | .5 |
| MKT 086 C | Sales Prospecting | .5 |
| MKT 087 C | Sales Presentations | .5 |
| MKT 088 C | Handling Sales Objections | .5 |
| MKT 089 C | Making the Sale | .5 |
| MGT 085 C | Business Planning | 1 |
| MGT 161 C | Introduction to Business | 3 |
| Total Units Required | | 12 |

SMALL BUSINESS OPERATIONS CERTIFICATE

Program Code: 1C31342

This certificate program provides students with information on the various steps and management and marketing decisions involved in starting and operating a business. Program is designed for both prospective and current business owners.

To earn a certificate, students must complete the required courses as listed with a minimum grade of "C." At least 50% of all course work must be completed at Cypress College.

Required courses are listed in suggested sequence:

| Course # | Title | Units |
|-----------------------------|--|-----------|
| MGT 085 C | Business Planning | 1 |
| MGT 086 C | Business Finance — Recordkeeping | .5 |
| MGT 087 C | Computer Technology for Small Business | .5 |
| MGT 088 C | Managing Personnel | .5 |
| MGT 089 C | Business Law — Small Business | .5 |
| MKT 090 C | Marketing Essentials | 1 |
| MKT 091 C | Advertising and Public Relations | 1 |
| MKT 092 C | Personal Selling | 1 |
| MKT 093 C | Target Marketing | .5 |
| MKT 094 C | Buyer Behavior | .5 |
| MKT 095 C | Market Distribution Systems | .5 |
| MKT 096 C | Sales Promotion Techniques | .5 |
| MKT 097 C | Customer Relations | .5 |
| MKT 098 C | International Marketing - Small Business | .5 |
| MGT 161 C | Introduction to Business | 3 |
| Total Units Required | | 12 |

SOCIAL MEDIA

MARKETING CERTIFICATE Program Code: 1C32651

This program is designed for students to learn how they can develop, penetrate, and use social networks to introduce and promote new products, provide customer services, and obtain marketing research information. Students will explore Web 2.0 tools and social networks, use them to collect and analyze market data to develop strategies that increase Internet sales. To earn a certificate, students will complete the required courses as listed with a minimum grade of "C." At least 50% of all course work must be completed at Cypress College.

Required courses are listed in suggested sequence

| Course | Title | Units |
|-----------------------------|---------------------------------|-----------|
| CIS 120 C | Internet and Social Media | 3 |
| CIS 221 C | Web Technology and Social Media | 3 |
| MKT 222 C | Principles of Marketing | 3 |
| MKT 103 C | Principles of Advertising | 3 |
| | or | |
| MKT 210 C | Consumer Behavior | (3) |
| Total Units Required | | 12 |

MARKETING TRANSFER PROGRAM

Refer to Catalog under:

BUSINESS ADMINISTRATION TRANSFER PROGRAM

Students should consult a counselor or www.assist.org for lower division major requirements for most California public universities. (See the Standard Definitions section of the catalog for a description of ASSIST.) Students transferring to an independent college/university should consult the catalog of the individual school and a counselor for lower division major requirements.

Marketing (MKT)

MKT 086 C Sales Prospecting .5 Units

Term hours: 9 lecture. This course focuses on ways to identify prospective customers and generate sales leads using such methods as mailing lists, databases, networking, referrals, and other information sources. Pass/No Pass only.

MKT 087 C Sales Presentations .5 Units

Term hours: 9 lecture. This course emphasizes the key elements of effective sales presentations and how to make each presentation come alive through the use of verbal, visual, and demonstration techniques. Pass/No Pass only.

MKT 088 C Handling Sales Objections .5 Units

Term hours: 9 lecture. This course shows how to get past "No," using various sales strategies to overcome customers' objections and to emphasize the benefits of a purchase. Pass/No Pass only.

MKT 089 C Making the Sale .5 Units

Term hours: 9 lecture. This course explains how and when to close a sale, focusing on techniques to use to complete the transaction and generate repeat sales and customer referrals. Pass/No Pass only.

MKT 090 C Marketing Essentials**1 Unit**

Term hours: 18 lecture. This course covers the marketing activities necessary to plan, promote, price and distribute a product or service to potential customers. It provides an understanding of the functions of producers, wholesalers, retailers, and others. Pass/No Pass only.

MKT 091 C Advertising and Public Relations**1 Unit**

Term hours: 18 lecture. This course explains the roles of advertising and public relations in promoting a business and provides strategies for identifying the target market and choosing a message and media. Pass/No Pass only.

MKT 092 C Personal Selling**1 Unit**

Term hours: 18 lecture. This course focuses on the main steps in the selling process, finding sales prospects, identifying needs and wants, giving effective sales presentations, handling objections, and closing the sale. Pass/No Pass only.

MKT 093 C Target Marketing**.5 Units**

Term hours: 9 lecture. This course focuses on the fundamentals of marketing research to identify target markets and find out what customers want. Topics include data collection, interview and survey techniques, Internet usage and trend analysis. Pass/No Pass only.

MKT 094 C Buyer Behavior**.5 Units**

Term hours: 9 lecture. This course explores the psychology of how and why customers buy, utilizing demographic and lifestyle factors to understand purchase decisions. Pass/No Pass only.

MKT 095 C Market Distribution Systems**.5 Units**

Term hours: 9 lecture. This course provides a thorough view of the distribution process, including the channels, types of retail outlets, methods of transportation, warehousing and inventory control. Pass/No Pass only.

MKT 096 C Sales Promotion Techniques**.5 Units**

Term hours: 9 lecture. This course provides information on the “non-media” techniques that can be used to promote a business, including coupons, gifts and contests, special events, participation in trade shows and other methods. Pass/No Pass only.

MKT 097 C Customer Relations**.5 Units**

Term hours: 9 lecture. This course explores the ways to maintain and improve customer relations, develop customer loyalty and increase the level of repeat sales. Pass/No Pass only.

MKT 098 C International Marketing - Small Business**.5 Units**

Term hours: 9 lecture. This course studies the international marketplace and the opportunities for businesses to engage in commerce outside of the U.S. Pass/No Pass only.

MKT 103 C Principles of Advertising**3 Units**

Term hours: 54 lecture. This course focuses on advertising and promotion, the print media, copy and layout, radio and television commercials, the Internet and social media, and public relations with an emphasis on what advertising agencies do. (CSU)

MKT 105 C Principles of Retailing**3 Units**

Term hours: 54 lecture. This course covers the principles of organizing and managing a retailing or E-tailing business, with emphasis on planning, site appeal, merchandise, pricing, and promotion, with an emphasis on customer service techniques. (CSU)

MKT 201 C Small Business Promotion**3 Units**

Term hours: 54 lecture. This course focuses on the techniques used to promote a small business and develop its marketing strategy. Its emphasis is on creating a marketing plan and devising affordable and effective ways to communicate with customers through media, and the Internet, sales promotion, public relations and publicity, brochures, direct mail and other methods. (CSU)

MKT 205 C Multicultural Markets in U.S.**3 Units**

Term hours: 54 lecture. This course provides comprehensive coverage of the multicultural marketing environment in the United States, taking into consideration the changing needs and growing influence of ethnic and racial minorities, women, and other groups. It explores the differences and commonalities that exist among groups and the role of businesses in providing goods and services to meet each group's needs. (CSU, CUL DIV)

MKT 208 C Principles of Selling**3 Units**

Term hours: 54 lecture. This course includes instruction in the principles and practices of the fundamentals of selling in today's global marketplace. Students will learn to develop the techniques that lead to building customer relationships and to success in the sales profession. The areas of study include buying motives; product knowledge; all phases of the selling process; ways to utilize the Internet; and the many and varied career opportunities in the sales field. Pass/No Pass/Letter Grade Option. (CSU)

MKT 210 C Consumer Behavior**3 Units**

Term hours: 54 lecture. This course provides a study of consumers and how and why they buy. It covers consumerism, needs and wants, culture, personality, family and lifestyle, and the psychology of advertising. (CSU)

MKT 222 C Principles of Marketing**3 Units**

Term hours: 54 lecture. This course studies the marketing activities required to plan, price, promote, and distribute goods or services to potential customers. The areas of study include market research, consumer behavior, product development, advertising, sales, Internet marketing, wholesaling and retailing, and international trade. (CSU)

MKT 224 C International Marketing**3 Units**

Term hours: 54 lecture. This course focuses on the opportunities and challenges of conducting business on an international scale. It provides comprehensive coverage of the marketing environment; importing/exporting; foreign economic, political and legal systems; cultural differences; international finance; marketing research; and business plans. (CSU)

MKT 299 C Merchandising and MKT-Independent Study**1 to 3 Units**

Prerequisite: Approved Independent Study Learning Contract.

Term hours: Lecture/discussion hours vary with credit given. The course is designed for students who wish to expand their knowledge in an area of merchandising/marketing through individual research and study. (CSU)

Mathematics

Division of Science/Engineering/Mathematics

Division Dean — Richard Fee

Faculty

- Jennifer Coopman
- Adam Eckenrode
- Garet Hill
- Nicole Ledesma
- Eunju Lee
- Laurie Morvan
- Kelly Nguyen
- David Nusbaum
- Sylvia Paek
- Christina Plett
- Cindy Shrout
- Hoa Tran
- Amy Ward

Counselor

Deidre Porter

PROGRAM LEARNING OUTCOMES (PLOs)

The courses taught by this department contribute to the General Education and Basic Skills Program Learning Outcomes. Please refer to General Education and Basic Skills Program Learning Outcomes.

Mathematics

Students who complete the mathematics program will be able to:

- Apply mathematical concepts, simplify expressions, and solve equations.
- Graph equations, and solve application problems using logic, constructions, and analytical reasoning.

ASSOCIATE IN SCIENCE IN MATHEMATICS FOR TRANSFER DEGREE (AS-T)

PROGRAM CODE: 1S32103

This curriculum is designed to provide an opportunity for the Mathematics major to achieve an Associate in Science in Mathematics for Transfer (AS-T in Mathematics) which completes the first and second year requirements for transfer to a four-year public California institution. Students with a degree in mathematics may pursue careers in a variety of industries such as education, finance, insurance, information technology, engineering and operations, manufacturing, consulting, analysis, research, and more. While at least a baccalaureate degree is recommended preparation for those considering professional careers, completion of this curriculum will demonstrate commitment to the field and provide comprehensive preparation for further academic study through upper-division course work. This curriculum specifically prepares the prospective transfer student for upper division course work in Mathematics or a similar major at a California State University (CSU) campus. Students should consult a counselor, the Transfer Center and the catalog of the transfer college or university to plan a specific program of study to meet the college or university's requirements.

Note: Courses that fulfill major requirements for an Associate Degree for Transfer at Cypress College might not be the same as those required for completing the major at all transfer institutions offering a Baccalaureate Degree. The Student Transfer Achievement Reform Act (Senate Bill 1440, now codified in California Education Code sections 66746–66749) guarantees admission to a California State University (CSU) campus for any community college student who completes an “associate degree for transfer,” a newly established variation of the associate degrees traditionally offered at a California community college. The AS-T is intended for students who plan to complete a bachelor’s degree in a similar major at a CSU campus. Students completing these degrees (AS-T) are guaranteed admission to the CSU system, but not to a particular campus or major. Students transferring to a CSU campus that does accept the AS-T will be required to complete no more than 60 units after transfer to earn a bachelor’s degree (unless the major is designated “high-unit” major). This degree may not be the best option for students intending to transfer to a particular CSU campus or to a university or college that is not part of the CSU system. Students should consult with a counselor when planning to complete the degree for more information on university admission and transfer requirements. The completion of this curriculum will demonstrate commitment to the Mathematics field and provide comprehensive preparation for upper-division work.

To earn an AS-T in Mathematics students must complete the following requirements: (1) a minimum of 21 semester units or 31.5 quarter units in the Mathematics major with a minimum grade of “C”; (2) California State University General Education Breadth requirements (CSU GE Breadth) or the Intersegmental General Education Transfer Curriculum (CSU IGETC); (3) completion of 60 semester or 90 quarter units of CSU transferable course work; and (4) have an overall GPA of 2.0.

| Required Courses: (12 units) | | Units |
|--|--|--------------|
| MATH 150AC | Calculus I | 4 |
| MATH 150BC | Calculus II | 4 |
| MATH 250AC | Multivariable Calculus | 4 |
| List A | | Units |
| MATH 250BC | Linear Algebra/Differential Equations | 5 |
| List B: Choose one course from the following: (4 units) | | Units |
| PHYS 221 C | General Physics I | 4 |
| | or | |
| MATH 120 C | Introduction to Probability and Statistics | (4) |
| Total Units Required | | 21 |

MATHEMATICS TRANSFER PROGRAM

Students should consult a counselor or www.assist.org for lower division major requirements for most California public universities. (See the Standard Definitions section of the catalog for a description of ASSIST.) Students transferring to an independent college/university should consult the catalog of the individual school and a counselor for lower division major requirements.

Math Flow Chart for Non-Science Majors

Courses

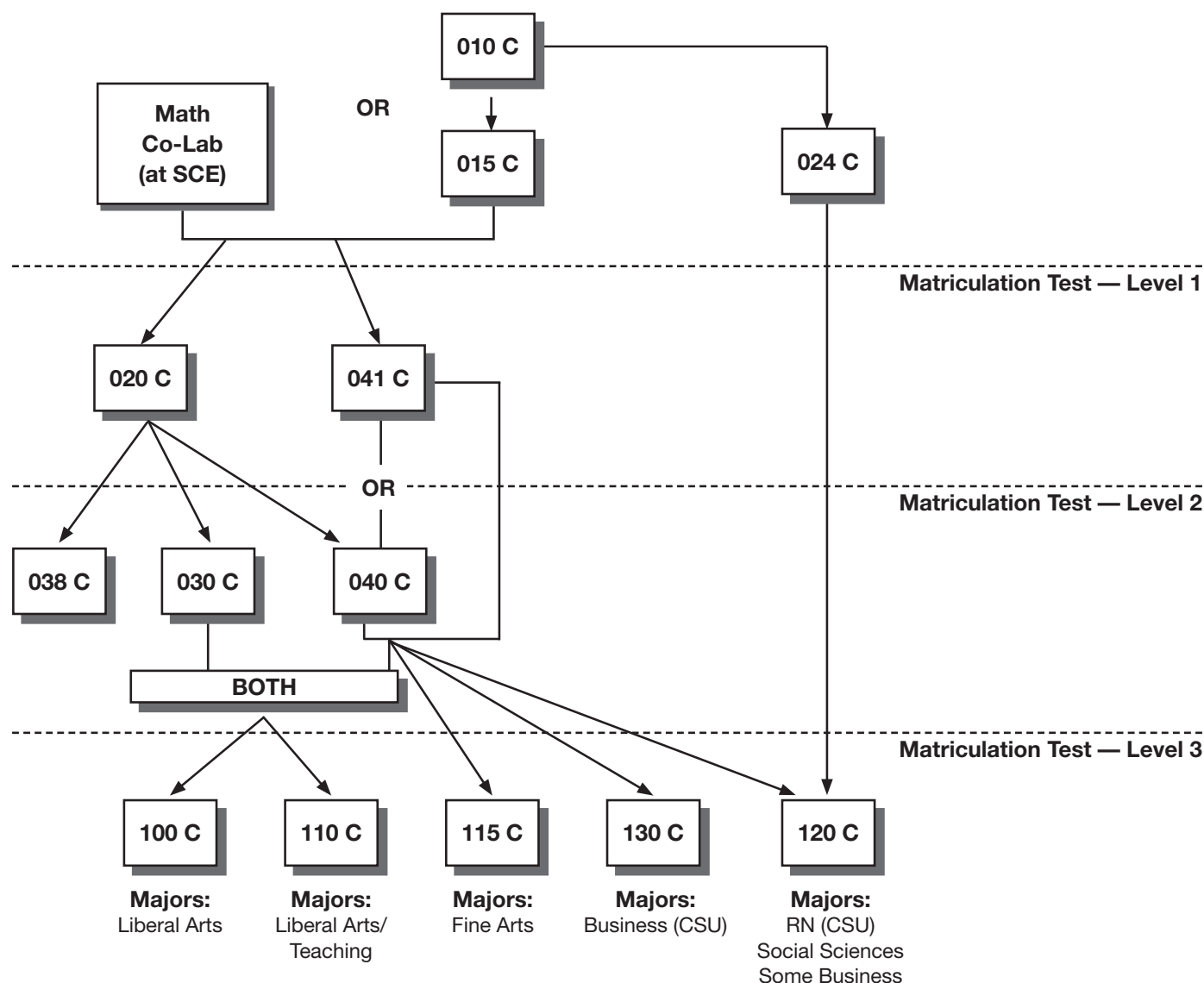

These majors are general references. Please consult with your academic counselor to confirm that the Math course you have selected fulfills your major requirement.

If you have not taken a Math course within the last two years, you are strongly advised to begin at a level that you have already completed with a "C" or better.

A graphing calculator is required for MATH 024 C, 115 C, 120 C, and 130 C. A scientific calculator is required for all other courses above MATH 010 C.

MATHEMATICS LEARNING CENTER (714) 484-7151

Students will find instructors and qualified tutors available for assistance in solving mathematical problems or in understanding mathematical concepts in the Mathematics Learning Center, located in Room 127 of the Library/Learning Resource Center.

MONDAY 8:00 am–8:00 pm
 TUESDAY 8:00 am–8:00 pm
 WEDNESDAY 8:00 am–8:00 pm
 THURSDAY 8:00 am–8:00 pm
 FRIDAY 10:00 am–3:00 pm

Flow Chart for Mathematics Courses for Science, Engineering and Mathematics Majors

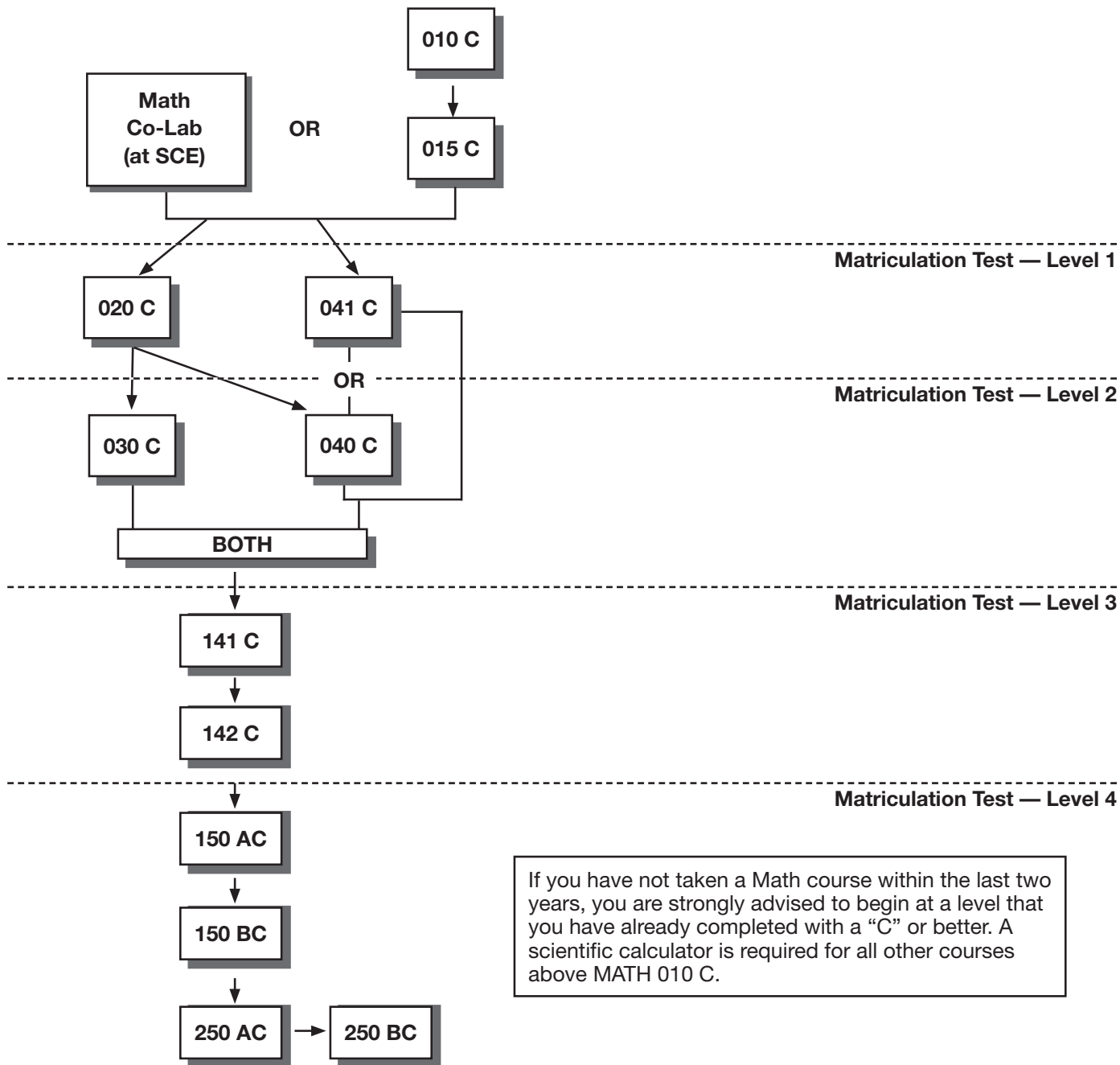

If you have not taken a Math course within the last two years, you are strongly advised to begin at a level that you have already completed with a “C” or better. A scientific calculator is required for all other courses above MATH 010 C.

MATHEMATICS LEARNING CENTER (714) 484-7151

Students will find instructors and qualified tutors available for assistance in solving mathematical problems or in understanding mathematical concepts in the Mathematics Learning Center, located in Room 127 of the Library/Learning Resource Center.

MONDAY 8:00 am–8:00 pm
 TUESDAY 8:00 am–8:00 pm
 WEDNESDAY 8:00 am–8:00 pm
 THURSDAY 8:00 am–8:00 pm
 FRIDAY 10:00 am–3:00 pm

Mathematics (MATH)

MATH 010 C Basic Mathematics 4 Units

Term hours: 72 lecture. This is a course for students wishing to review basic arithmetic skills. It includes the concepts of adding, subtracting, multiplying, and dividing whole numbers, fractions, mixed numbers, and decimals. Also covered will be percents, ratios, rates, solving proportions, perimeter and area of geometric figures, English and Metric measurements and an introduction to negative numbers. There will be an emphasis on applying the mathematics to real-world situations. Non-Degree Credit.

MATH 015 C Pre-Algebra 4 Units

Prerequisite: MATH 010 C or Basic Mathematics with a grade of "C" or better and the assessment process. Proof of prerequisites is required.
Term hours: 72 lecture. This course is designed for students who are planning to study algebra and need a review of the basic skills of arithmetic and an introduction to the basic principles of algebra. Topics covered include integers, fractions, decimals, percent, proportions, exponents, properties of real numbers, evaluation of algebraic expressions, elementary equation solving, formulas, informal geometry, and applications. This course requires a non-graphing scientific calculator. Non-Degree Credit.

MATH 020 C Elementary Algebra 4 Units

Prerequisite: MATH 015 C or Pre-algebra with a grade of "C" or better and the assessment process. Proof of prerequisites is required.
Term hours: 72 lecture. This course is an introduction to the methods of algebra. It includes the basic operations of real numbers, polynomials, rational expressions, and radical expressions; factoring polynomials; solutions of linear equations, linear inequalities, systems of linear equations, and quadratic equations; and graphing of linear equations, systems, and inequalities. This course requires the use of a non-graphing scientific calculator. Students who have completed MATH 020 C are allowed to take MATH 040 C or MATH 041 C. Non-Degree Credit.

MATH 024 C Pre-Statistics 6 Units

Prerequisite: MATH 010 C or Basic Mathematics with a grade of "C" or better and the assessment process. Proof of prerequisites is required.
Term hours: 108 lecture. This course is for students planning to enroll in MATH 120 C or PSY/SOC 161 C. It covers the requisite algebra topics including graphing linear equations, as well as organizing and summarizing quantitative and qualitative data, laws of probability, discrete and continuous probability distributions, application problems, and use of the TI-83/84 graphing calculator. Non-Degree Credit.

MATH 030 C Plane Geometry 4 Units

Prerequisite: MATH 020 C or MATH 041 C or Algebra I with a grade of "C" or better and the assessment process. Proof of prerequisites is required.
Term hours: 72 lecture. This course is an introduction to Euclidean geometry. It includes the study of elementary logic, deductive reasoning, parallel and perpendicular relationships, theorems and proofs, geometric constructions, congruent and similar polygons, special right triangles, circles, geometric loci, areas, perimeters and volumes. Precise definitions and accuracy of statements are stressed as background for analytical reasoning. This course requires the use of a non-graphing scientific calculator and is equivalent to one year of high school geometry. (AA GE)

MATH 038 C Practical Mathematics for Life 4 Units

Prerequisite: A minimum grade of "C" in MATH 020 C or MATH 041 C or Algebra I with a grade of "C" or better and the assessment process. Proof of prerequisites is required.
Term hours: 72 lecture. This course uses the concepts of beginning algebra, problem solving skills, and analytical thinking to solve real world applications involving fractions, financial management, logic, geometry, probability and statistics. It meets the minimum mathematics requirement for an associate's degree but does not satisfy the prerequisite for a transferable math course. (AA GE)

MATH 040 C Intermediate Algebra 4 Units

Prerequisite: MATH 020 C or Algebra I with a grade of "C" and the assessment process. Proof of prerequisites is required.
Term hours: 72 lecture. This is a second course in algebra that includes the topics of sets, axioms for the real number system, polynomials, solutions of linear and quadratic equations and inequalities, exponents and radicals, linear, quadratic, exponential and logarithmic functions and their graphs, and systems of equations. This course requires the use of a non-graphing scientific calculator. Students may not receive credit for both MATH 040 C and MATH 041 C. (AA GE)

MATH 041 C Combined Algebra I and II 6 Units

Prerequisite: MATH 015 C or pre-algebra with minimum grades of "C", and the assessment process. Proof of prerequisites is required.
Term hours: 108 lecture. This course is designed for students who would like to complete Elementary and Intermediate Algebra in one semester. It covers linear, quadratic, and absolute value equations and inequalities, rational and radical equations, operations with polynomials, radicals, and rational expressions, systems of linear equations, and linear, quadratic, exponential, and logarithmic functions and their graphs. Students may not receive credit for both MATH 040 C and MATH 041 C. Students who have completed MATH 020 C are allowed to take MATH 040 C or MATH 041 C. (AA GE)

MATH 098 C Mathematics Seminar .5 to 4 Units

Prerequisite: May be required.
Corequisite: May be required.
Advisory: May be required.
Term hours: 9-72 lecture depending on units attempted. This is a lecture/discussion approach to special topics involving mathematics. It may be a problem session relating to a particular course in the curriculum or a study of topics not ordinarily covered in the curriculum. Consult the class schedule to verify unit credit for a particular semester. Pass/No Pass/Letter Grade Option. Fees may be required-Payable at Registration.

MATH 100 C Liberal Arts Mathematics 3 Units

Prerequisite: MATH 030 C or Plane Geometry and MATH 040 C or MATH 041 C or Algebra II with grades of "C" or better and the assessment process. Proof of prerequisites is required.
Term hours: 54 lecture. This is a survey course with selected topics from the history and development of mathematics, elementary logic and set theory, probability, statistics, geometry, and exponential and logarithmic applications. The course is designed for prospective teachers and liberal arts students. (UC/CSU, AA GE, CSU GE, IGETC)

MATH 110 C Math for Prospective Teachers 4 Units

Prerequisite: MATH 030 C and MATH 040 C or MATH 041 C or Algebra II with minimum grades of "C" and the assessment process. Proof of prerequisites is required.
Term hours: 72 lecture. This course is an introduction to problem solving processes and strategies. Students explore the development and analysis of the structure and operations of the real number system. Students focus on concept and process development using appropriate models, manipulatives, and activities. This course is designed for prospective elementary and middle school teachers. This course requires the use of a non-graphing scientific calculator. (UC/CSU, AA GE, CSU GE)

MATH 115 C Finite Mathematics 4 Units

Prerequisite: MATH 040 C or MATH 041 C or Algebra II with a grade of "C" or better and the assessment process. Proof of prerequisites is required.
Term hours: 72 lecture. This course covers graphing, finance, matrices, linear systems, linear programming, combinatorial analysis, probability, and descriptive statistics. Applications to the fields of business, economics, biological sciences, and behavioral sciences are emphasized. This course requires the use of a graphing calculator comparable to the TI-83/84. (UC/CSU, AA GE, CSU GE, IGETC, C-ID: MATH 130)

MATH 120 C Introduction to Probability and Statistics 4 Units

Prerequisite: MATH 040 C or MATH 041 C or Algebra II with a grade of "C" or better and the assessment process or a minimum grade of "C" in MATH 024 C. Proof of prerequisites is required.

Term hours: 72 lecture. This course is an introduction to the elements of statistical analysis which includes an intuitive approach to the study of probability and probability distributions, measures of central tendency and dispersion, sampling techniques, parametric and non-parametric tests of hypotheses, point and interval estimation, linear regression and correlation. Applications to business, biological sciences, and social sciences are emphasized. Students will use computer software and/or graphing calculators for statistical analysis of various topics. This course requires the use of a graphing calculator comparable to the TI-83/84. Duplicate credit not granted for MATH 120HC. (UC Credit Limitation/CSU, AA GE, CSU GE, IGETC, C-ID: MATH 110, C-ID: SOCI 125)

MATH 130 C Survey of Calculus 4 Units

Prerequisite: MATH 040 C or MATH 041 C or Algebra II with a grade of "C" or better and the assessment process. Proof of prerequisites is required.

Term hours: 72 lecture. This course is an introduction to calculus with an emphasis on solution techniques and applications rather than abstract theory. It includes elements of analytic geometry, limits, derivatives, integration as a summation process, exponential and logarithmic functions, integration of basic forms, techniques of integration, an introduction to multi-variable calculus, and curve sketching, with applications from the life sciences, engineering technology, economics, and the social sciences. This course requires the use of a graphing calculator comparable to the TI-83/ TI-84. Credit by Examination. (UC Credit Limitation/CSU, AA GE, CSU GE, IGETC, C-ID: MATH 140)

MATH 141 C College Algebra 4 Units

Prerequisite: MATH 030 C and MATH 040 C or MATH 041 C with grades of "C" or better or plane geometry and Algebra II with grades of "C" or better and the assessment process. Proof of prerequisites is required.

Term hours: 72 lecture. This is one of two courses to prepare students for the calculus sequence. The topics covered include a review of the fundamentals of algebra; rational, exponential and logarithmic functions; theory of equations and zeros of polynomial functions; systems of equations including linear and quadratic systems; sequences and series; mathematical induction; permutations; combinations; binomial theorem; analytic geometry; conic sections; and miscellaneous topics. (UC/CSU, AA GE, CSU GE, IGETC)

MATH 142 C Trigonometry 4 Units

Prerequisite: MATH 141 C or the equivalent of Math Analysis or Precalculus with a grade of "C" or better.

Term hours: 72 lecture. This is a one-semester course in trigonometry designed to prepare students for the study of calculus. The topics to be covered include the following: measurements of angles, trigonometric and inverses trigonometric functions and their graphs, solving trigonometric equations, verifying trigonometric identities, solutions of triangles, complex numbers, polar coordinates, vectors, DeMoivre's Theorem, and parametric equations. (CSU, AA GE, CSU GE)

MATH 150AC Calculus I 4 Units

Prerequisite: MATH 141 C and MATH 142 C or trigonometry and math analysis/precalculus with grades of "C" or better and the assessment process. Proof of prerequisites is required.

Term hours: 72 lecture. This course is an introduction to mathematical analysis. It includes the study of analytic geometry, functions and limits, continuity, differentiation and integration. Problem work includes applications involving derivatives, definite integrals and indefinite integrals. Credit by Examination. (UC Credit Limitation/CSU, AA GE, CSU GE, IGETC, C-ID: MATH 210, C-ID: MATH 900S = MATH 150AC + 150BC)

MATH 150BC Calculus II 4 Units

Prerequisite: MATH 150AC or Calculus I and Analytic Geometry with a grade of "C" or better and the assessment process. Proof of prerequisites is required.

Term hours: 72 lecture. This course is a continuation of MATH 150AC. It includes the study of applications of integration, techniques of integration, improper integrals, sequences, infinite series, power series, Taylor and Maclaurin series, conic sections, parametric equations, polar coordinates, and a brief introduction to differential equations. Credit by Examination. (UC/CSU, AA GE, CSU GE, IGETC, C-ID: MATH 221, C-ID: MATH 900S = MATH 150AC + 150BC)

MATH 250AC Multivariable Calculus 4 Units

Prerequisite: MATH 150BC or Calculus II and Analytic Geometry with a grade of "C" or better and the assessment process. Proof of prerequisites is required.

Term hours: 72 lecture. This is an intermediate course in mathematical analysis. It includes the study of three-dimensional analytic geometry, calculus of functions of several variables, vector calculus, multiple integration, vector fields and theorems, with associated problem applications. Credit by Examination. (UC/CSU, AA GE, CSU GE, IGETC, C-ID: MATH 230)

MATH 250BC Linear Algebra/Differential Equations 5 Units

Prerequisite: MATH 250AC or Calculus III and Analytic Geometry with a grade of "C" or better and the assessment process.

Term hours: 90 lecture. This course is an introduction to linear algebra and ordinary differential equations. Linear algebra includes matrices, determinants, vector spaces, linear transformations, and characteristic values. Differential equations includes separable, exact, Cauchy-Euler, and non-homogeneous equations; undetermined coefficients, variation of parameters, systems of differential equations, power series solutions, and Laplace Transforms. Credit by Examination. (UC/CSU, AA GE, CSU GE, IGETC, C-ID: MATH 240)

MATH 298 C Mathematics Seminar .5 to 4 Units

Prerequisite: May be required.

Corequisite: May be required.

Advisory: May be required.

Term hours: 9-72 lecture depending on units attempted. This is a lecture/discussion approach to special topics involving mathematics. It may be a problem session related to a particular course in the curriculum, or a study of topics not ordinarily covered in the curriculum. Consult the class schedule to verify unit credit for a particular semester. Pass/No Pass or Pass/No Pass/Letter Grade Option or Standard Letter Grade. Fees may be required-Payable at Registration. (UC Credit Limitation/CSU)

MATH 299 C Mathematics Independent Study .5 to 2 Units

Prerequisite: Approved Independent Study Learning Contract.

Term hours: 9-36 lecture depending on units attempted. This course is for students who have demonstrated interest in and capability for increased knowledge of mathematical topics not ordinarily covered in curriculum courses. Students will participate in independent study or research on assigned projects under staff supervision. (UC Credit Limitation/CSU)

Media Arts Design

(formerly Art Computer Graphics, ACG)

Division of Fine Arts

Division Dean — Katy Realista

Faculty

Jeff Cain
Edward Giardina
Ian Holmes

Counselors

Renay Laguana-Ferinac
Renee Ssensalo

PROGRAM LEARNING OUTCOMES (PLOs)

Media Arts Design

- Given a variety of media arts design, web design, video, cinema, and animation processes, students will be able to demonstrate their knowledge of various computer graphics, cinema and time based processes, theory, and technical skills.
- Given media arts design, web design, video, cinema, and animation materials, students will be able to effectively communicate content through the principles and elements of design.
- Given media arts design, web design, video, cinema, and animation works and materials, students will be able to critically analyze the principles and elements of design for content and historical importance.
- Students will develop artistic skills to visually articulate and comprehend the interconnection between media arts design, web design, video, cinema, design and culture.

ANIMATION 2D COMPUTER GRAPHICS CERTIFICATE **Program Code: 1C15693**

This Animation 2D Computer Graphics Certificate provides the skills necessary for publishing animation on websites. Students will learn to create digital drawings, paintings and illustrations for the purpose of creating two-dimensional animated cartoons and interactive games suitable for the Internet and CD-ROMs. Emphasis is placed on development of a portfolio for employment and/or advancement.

To earn a certificate, students must complete the required courses as listed with a minimum grade of "C." At least 50% of all course work must be completed at Cypress College.

Required courses are listed in numeric sequence:

| Course # | Title | Units |
|-----------------------------|-----------------------------------|-----------|
| ART 120 C | Two-Dimensional Design | 3 |
| *ART 182 C | Beginning Drawing | 3 |
| MAD 102 C | Introduction to Mac WEB Graphics | 3 |
| | or | |
| MAD 200 C | Storyboarding, Comics, Pre Visual | (3) |
| MAD 134 C | Digital Imaging/Mac | 3 |
| | or | |
| MAD 135 C | Digital Imaging/Win | (3) |
| MAD 164 C | Adobe Flash Designer/Mac | 3 |
| | or | |
| MAD 165 C | Adobe Flash Designer/Win | (3) |
| | or | |
| MAD 193 C | Introduction to 2D Animation | (3) |
| Total Units Required | | 15 |

*A score of 3 or higher on the Advanced Placement (AP) Art (Studio Drawing) exam with portfolio meets this requirement upon petition through Admissions and Records. See a counselor for more information.

ANIMATION 3D COMPUTER GRAPHICS CERTIFICATE **Program Code: 1C15694**

The Animation 3D Computer Graphics Certificate provides the skills necessary to create three dimensional models and 3D animated short films appropriate for use in movies, television, electronic gaming, and Internet distribution. Emphasis is placed on development of a portfolio for employment and/or advancement.

To earn a certificate, students must complete the required courses as listed with a minimum grade of "C." At least 50% of all course work must be completed at Cypress College.

Required courses are listed in numeric sequence:

| Course # | Title | Units |
|-----------------------------|-----------------------------------|-----------|
| MAD 104 C | Introduction to MAC 3D Graphics | 3 |
| | or | |
| MAD 105 C | Introduction to WIN 3D Graphics | (3) |
| | or | |
| MAD 120 C | 3D Modeling/Mac | (3) |
| | or | |
| MAD 121 C | 3D Modeling/Win | (3) |
| MAD 150 C | Intermediate Animation/Mac | 3 |
| | or | |
| MAD 151 C | Intermediate Animation/Win | (3) |
| MAD 156 C | Advanced Animation/Mac | 3 |
| | or | |
| MAD 157 C | Advanced Animation/Win | (3) |
| MAD 180 C | Video Editing/MAC | 3 |
| | or | |
| MAD 181 C | Video Editing/WIN | (3) |
| MAD 200 C | Storyboarding, Comics, Pre Visual | 3 |
| Total Units Required | | 15 |

**COMPUTER GRAPHICS
CERTIFICATE**

Program Code: 1C03815

The Computer Graphics program provides the skills necessary to create raster based digital drawings, paintings and illustrations. Emphasis is placed on development of a portfolio for employment and/or advancement.

To earn a certificate, students must complete the required courses as listed with a minimum grade of "C." At least 50% of all course work must be completed at Cypress College.

Required courses are listed in suggested sequence:

| Course # | Title | Units |
|--|---|-----------|
| ART 120 C | Two-Dimensional Design | 3 |
| *ART 182 C | Beginning Drawing | 3 |
| ART 194 C | Beginning Painting | 3 |
| ART 244 C | Illustration | 3 |
| MAD 100 C | Introduction to Computer Graphics/Mac or | 3 |
| MAD 101 C | Introduction to Computer Graphics/Win or | (3) |
| MAD 102 C | Introduction to Mac WEB Graphics or | (3) |
| MAD 103 C | Introduction to Win WEB Graphics | (3) |
| MAD 112 C | Electronic Illustration/Mac or | 3 |
| MAD 113 C | Electronic Illustration/Win | (3) |
| MAD 132 C | Electronic Paint/Mac or | 3 |
| MAD 133 C | Electronic Paint/Win | (3) |
| MAD 134 C | Digital Imaging/Mac or | 3 |
| MAD 135 C | Digital Imaging/Win | (3) |
| Select a minimum of 6 units from the elective courses listed below | | 6 |
| Total Units Required | | 30 |

Electives

| | | |
|-----------|-------------------------------------|-----|
| ART 140 C | Graphic Design 1 | 3 |
| ART 185 C | Beginning Life Drawing | 3 |
| MAD 114 C | Electronic Illustration 2/Mac or | 3 |
| MAD 115 C | Electronic Illustration 2/Win | (3) |

*A score of 3 or higher on the Advanced Placement (AP) Art (Studio Drawing) exam with portfolio meets this requirement upon petition through Admissions and Records. See a counselor for more information.

**DIGITAL CINEMA ARTS AND INDUSTRY
CERTIFICATE**

Program Code: 1C30290

The Digital Cinema Arts and Industry Certificate provides a foundation in the field of time-based media creation which includes video and audio recording for multiple platform exhibition and distribution. The certificate will prepare students to enter the fields of motion picture, television, multimedia, Internet and wireless media by providing a foundation set of courses that cover digital content creation. Students will learn the operation and application of software and hardware specific to these industries.

To earn a certificate, students must complete the required courses as listed with a minimum grade of "C." At least 50% of all course work must be completed at Cypress College.

| | | Units |
|-----------------------------|--------------------------------------|-----------|
| MM 100 C | Introduction to Electronic Media | 3 |
| MAD 107 C | Motion Graphics I | 3 |
| MAD 109 C | Digital Video Production I/MAC or | 3 |
| MAD 188 C | Beginning Single Camera Prod | (3) |
| MAD 194 C | Beginning Motion Picture Prod | 3 |
| MAD 110 C | Animation History/Technology or | 3 |
| MAD 196 C | Silent Film Genre or | (3) |
| MAD 200 C | Storyboarding, Comics, Pre Visual | (3) |
| MAD 180 C | Video Editing/MAC or | 3 |
| MAD 181 C | Video Editing/WIN or | (3) |
| MAD 295 C | Media Arts Design Internship | (3) |
| Total Units Required | | 18 |

DIGITAL CINEMA PRODUCTION

CERTIFICATE

Program Code: 1C30289

The Digital Cinema Production certificate provides production knowledge and skills used by digital artists to perform a variety of production duties in the live-action and animation areas of motion picture and time-based media creation. This certificate is the second certificate in a sequence of skills based certificates for Digital Cinema.

To earn a certificate, students must complete the required courses as listed with a minimum grade of "C." At least 50% of all course work must be completed at Cypress College.

Required courses are listed in suggested sequence

| | | Units |
|-----------------------------|------------------------------------|-----------|
| MAD 185 C | Documentary Digital Cinema | 3 |
| MAD 187 C | Motion Graphics II | 3 |
| MAD 188 C | Beginning Single Camera Prod | 3 |
| MAD 186 C | Wedding and Event Videography | 3 |
| MAD 183 C | Preproduction for Filmmakers | 3 |
| MAD 191 C | Film Noir Genre or | 3 |
| MAD 192 C | Great Directors of Cinema or | (3) |
| MAD 193 C | Introduction to 2D Animation or | (3) |
| THEA 230 C | Directing Actors for Film/TV | (2) |
| Total Units Required | | 18 |

**DIGITAL CINEMA TECHNIQUES
AND TECHNOLOGIES**

CERTIFICATE

Program Code: 1C31229

The Digital Cinema Techniques and Technologies certificate provides both historical and technical knowledge of cinema skills and practices. These areas are examined by specific film genre. Development of lighting, filming, recording, editing and directing are focused on within this certificate.

To earn a certificate, complete the required courses as listed with a minimum grade of "C." At least 50% of all course work must be completed at Cypress College.

Required courses are listed in numeric sequence:

| | | Units |
|-----------------------------|--------------------------------|-----------|
| MAD 109 C | Digital Video Production I/MAC | 3 |
| MAD 192 C | Great Directors of Cinema | 3 |
| MAD 197 C | Western Film Genre | 3 |
| MUS 127 C | Music in Film | 3 |
| THEA 230 C | Directing Actors for Film/TV | 2 |
| Total Units Required | | 14 |

POST PRODUCTION BASICS FOR CINEMA AND VIDEO

CERTIFICATE

Program Code: 1C31200

The Post Production Basics for Cinema and Video certificate will teach students to use computer hardware and software to add sound and music to an existing video recording or digital film. In addition, it will teach students how to edit video and combine live action and animated content with visual effects.

To earn a certificate, complete the required courses as listed with a minimum grade of "C." At least 50% of all course work must be completed at Cypress College.

| Required courses are listed in numeric sequence: | | Units |
|---|------------------------------|--------------|
| MAD 180 C | Video Editing/MAC | 3 |
| MAD 195 C | Science Fiction Film Genre | 3 |
| MUS 222 C | Audio Production for Film I | 3 |
| MUS 223 C | Audio Production for Film II | 3 |
| Total Units Required | | 12 |

ELECTRONIC PUBLISHING DESIGN

CERTIFICATE

Program Code: 1C07834

The Electronic Publishing Design Program provides the skills necessary to create Ad-design art and to generate digital "camera ready" page layouts. Emphasis is placed on development of a portfolio for employment and/or advancement.

To earn a certificate, students must complete the required courses as listed with a minimum grade of "C." At least 50% of all course work must be completed at Cypress College.

| Required courses are listed in suggested sequence: | | Units |
|---|---|--------------|
| ART 120 C | Two-Dimensional Design | 3 |
| ART 182 C | Beginning Drawing | 3 |
| ART 140 C | Graphic Design 1 | 3 |
| MAD 144 C | Graphic Design 2 | 3 |
| MAD 100 C | Introduction to Computer Graphics/Mac or | 3 |
| MAD 101 C | Introduction to Computer Graphics/Win or | (3) |
| MAD 102 C | Introduction to Mac WEB Graphics or | (3) |
| MAD 103 C | Introduction to Win WEB Graphics | (3) |
| MAD 112 C | Electronic Illustration/Mac or | 3 |
| MAD 113 C | Electronic Illustration/Win | (3) |
| MAD 134 C | Digital Imaging/Mac or | 3 |
| MAD 135 C | Digital Imaging/Win | (3) |
| MAD 145 C | Graphic Design 3 | 3 |
| ART 244 C | Illustration | 3 |

Electives

| A minimum of 3 Units from the elective courses listed below | | Units |
|--|------------------------------|--------------|
| ART 130 C | Introduction to Printmaking | 3 |
| ART 185 C | Beginning Life Drawing | 3 |
| MAD 295 C | Media Arts Design Internship | 3 |
| Total Units Required | | 30 |

VECTOR ILLUSTRATION CERTIFICATE

Program Code: 1C12358

The Computer Graphics program provides the skills necessary to create vector based digital drawings, paintings and illustrations. Emphasis is placed on development of a portfolio for employment and/or advancement.

To earn a certificate, students must complete the required courses as listed with a minimum grade of "C." At least 50% of all course work must be completed at Cypress College.

Required courses are listed in suggested sequence:

| Course # | Title | Units |
|--|---|--------------|
| ART 120 C | Two-Dimensional Design | 3 |
| ART 182 C | Beginning Drawing | 3 |
| ART 194 C | Beginning Painting | 3 |
| ART 244 C | Illustration | 3 |
| MAD 100 C | Introduction to Computer Graphics/Mac or | 3 |
| MAD 101 C | Introduction to Computer Graphics/Win or | (3) |
| MAD 102 C | Introduction to Mac WEB Graphics or | (3) |
| MAD 103 C | Introduction to Win WEB Graphics | (3) |
| MAD 112 C | Electronic Illustration/Mac or | 3 |
| MAD 113 C | Electronic Illustration/Win | (3) |
| MAD 114 C | Electronic Illustration 2/Mac or | 3 |
| MAD 115 C | Electronic Illustration 2/Win | (3) |
| MAD 134 C | Digital Imaging/Mac or | 3 |
| MAD 135 C | Digital Imaging/Win | (3) |
| Select a minimum of 6 units from the elective courses listed below | | 6 |
| Total Units Required | | 30 |

Electives

| | | |
|-----------|----------------------------|-----|
| MAD 132 C | Electronic Paint/Mac or | 3 |
| MAD 133 C | Electronic Paint/Win | (3) |
| ART 140 C | Graphic Design 1 | 3 |
| ART 185 C | Beginning Life Drawing | 3 |

MULTIMEDIA PRODUCTION BASICS

CERTIFICATE

Program Code: 1C31194

The Multimedia Production Basics certificate provides a foundation of multimedia content creation skills necessary to be a competent multimedia author for social media and business communications and entertainment industry media.

To earn a certificate, complete the required courses as listed with a minimum grade of "C." At least 50% of all course work must be completed at Cypress College.

| Required courses are listed in numeric sequence: | | Units |
|---|----------------------------------|--------------|
| MAD 119 C | Multimedia Mobile Design | 3 |
| MAD 184 C | Digital Video Explorations | 3 |
| MUS 108 C | Introduction to Music Technology | 3 |
| MUS 127 C | Music in Film | 3 |
| Total Units Required | | 12 |

Media Arts Design (MAD)

MAD 100 C Introduction to Media Arts Design-Mac 3 Units

Term hours: 36 lecture and 72 laboratory TBA. This course focuses on the use of electronic or digital; paint, drawing, digital imaging, video capture and output, animated gif's, and page layout programs. The use of various Macintosh input and output devices will be covered. Designed for artists to input, create, manipulate and output graphic imagery including static, video and motion graphic elements. This class is intended as a gateway into the varied offerings of the Media Arts Design program, where the student can pursue more in-depth study on the topic(s) that most attracted them during this introductory class. \$20.00 Material Fee - Payable at Registration. (CSU, C-ID: ARTS 250)

MAD 101 C Introduction to Media Arts Design-Win 3 Units

Term hours: 36 lecture and 72 laboratory TBA. This course focuses on the use of electronic or digital; paint, drawing, digital imaging, video capture and output, animated gif's, and page layout programs. The use of various Windows input and output devices will be covered. Designed for artists to input, create, manipulate and output graphic imagery including static, video and motion graphic elements. This class is intended as a gateway into the varied offerings of the Media Arts Design program, where the student can pursue more in-depth study on the topic(s) that most attracted them during this introductory class. \$20.00 Material Fee - Payable at Registration. (UC/CSU, C-ID: ARTS 250)

MAD 102 C Introduction to WEB Graphics-Mac 3 Units

Term hours: 36 lecture and 72 laboratory TBA. This is an overview of the many uses of computer multimedia, with an emphasis on electronic publishing over the Internet. In the course of the semester, the students create a personal web page enriched with such audiovisual elements as animation, sound, video, 3-D, and different types of still images. This class is intended as a gateway into the varied offerings of the Art Computer Graphics program, where the student can pursue more in-depth study on the topic(s) that most attracted them during this introductory class. \$20.00 Material Fee - Payable at Registration. (CSU)

MAD 103 C Introduction to WEB Graphics-Win 3 Units

Term hours: 36 lecture and 72 laboratory TBA. This is an overview of the many uses of computer multimedia, with an emphasis on electronic publishing over the Internet. In the course of the semester, the students create a personal Web page enriched with such audiovisual elements as animation, sound, video, 3-D, and different types of still images. This class is intended as a gateway into the varied offerings of the Art Computer Graphics program, where the student can pursue more in-depth study on the topic(s) that most attracted them during this introductory class. \$20.00 Material Fee - Payable at Registration. (CSU)

MAD 104 C Introduction to 3D Graphics-Mac 3 Units

Term hours: 36 lecture and 72 laboratory TBA. This is an overview of 3D computer graphics, with an emphasis on 2D paint and 3D modeling & animation software used in animation on the Macintosh. In the course of the semester, students create original 3D still and animation imagery for their portfolio. This class is intended as a gateway into the varied offerings of the Art Computer Graphics program, where the student can pursue more in-depth study on the topic(s) that most attracted them during this introductory class. \$20.00 Material Fee - Payable at Registration. (CSU)

MAD 105 C Introduction to 3D Graphics-Win 3 Units

Term hours: 36 lecture and 72 laboratory TBA. This is an overview of 3D computer graphics, with an emphasis on 2D paint and 3D modeling & animation software used in animation on a Windows computer. In the course of the semester, students create original 3D still and animation imagery for their portfolio. This class is intended as a gateway into the varied offerings of the Art Computer Graphics program, where the student can pursue more in-depth study on the topic(s) that most attracted them during this introductory class. \$20.00 Material Fee - Payable at Registration. (CSU)

MAD 107 C Motion Graphics I 3 Units

Term hours: 36 lecture and 72 laboratory TBA. This course introduces students to the motion graphics capabilities of Apple Motion. Projects assigned during the course will increase students' skill with both the creative and the technical challenges posed by motion graphics based on common professional uses of Apple Motion for web, broadcast and film industries. Students will create projects that will be suitable for use in video and animation productions. \$20.00 Materials Fee - Payable at Registration. (CSU)

MAD 108 C Digital Video Production I/Win 3 Units

Term hours: 36 lecture and 72 laboratory TBA. This course introduces Windows digital video production techniques including single camera operation and procedures, basic principles and techniques of sound and scriptwriting, and digital video editing. Course topics include the operation of digital camcorders; lighting and sound equipment and post production digital editing suites; concepts and techniques of nonlinear digital editing, including organization of the editing process; working the time line and audio editing, with emphasis on the principles and aesthetics of video editing. \$20.00 Materials Fee - Payable at Registration. (CSU)

MAD 109 C Digital Video Production I/Mac 3 Units

Term hours: 36 lecture and 72 laboratory TBA. This course introduces digital video Macintosh production techniques including single camera operation and procedures, basic principles and techniques of sound and scriptwriting, and digital video editing. Course topics include the operation of digital camcorders; lighting and sound equipment and post production digital editing suites; concepts and techniques of nonlinear digital editing, including organization of the editing process; working the time line and audio editing, with emphasis on the principles and aesthetics of video editing. \$20.00 Material Fee - Payable at Registration. (CSU)

MAD 110 C Animation History and Technology 3 Units

Term hours 54 lecture. This course is an introduction to the history and technological development of the field of animation. Animation will be explored from various perspectives: chronology, form, culture, and by personality. Emphasis is placed on examining how animation records, reflects and comments on world events and culture. (CSU)

MAD 111 C Introduction to Media Writing 3 Units

Advisory: Eligibility for ENGL 100 C.

Term hours: 54 lecture. Basic introductory course in writing for the film and electronic media. Emphasis on preparing scripts in proper formats, including fundamental technical, conceptual and stylistic issues related to writing fiction and non-fiction scripts for informational and entertainment purposes in film and electronic media. Includes a writing evaluation component as a significant part of the course requirement. (CSU)

MAD 112 C Electronic Illustration-Mac 3 Units

Term hours: 36 lecture and 72 laboratory TBA. The course focuses on the Macintosh generation of Postscript (vector) images for integration into desktop publishing/page layout software and as stand-alone images allowing high resolution output. The course offers the professional artist basic Macintosh skills needed for employment and/or advancement. \$20.00 Material Fee - Payable at Registration. (CSU)

MAD 113 C Electronic Illustration-Win 3 Units

Term hours: 36 lecture and 72 laboratory TBA. The course focuses on the Windows generation of Postscript (vector) images for integration into desktop publishing/page layout software and as stand-alone images allowing high-resolution output. The course offers the professional artist basic Windows skills needed for employment and/or advancement. \$20.00 Material Fee - Payable at Registration. (CSU)

MAD 114 C Electronic Illustration II-Mac 3 Units

Term hours: 36 lecture and 72 laboratory TBA. This course is intended for the graphic designer, illustrator and fine artist, focusing on the advanced usage of several 2D vector based drawing software packages. The course focuses on the advanced usage of Macintosh generation of Postscript (vector) images for integration into desktop publishing/page layout software and as stand-alone images allowing high-resolution output. The course offers the professional artist advanced Macintosh skills needed for employment and/or advancement. \$20.00 Material Fee - Payable at Registration. (CSU)

MAD 115 C Electronic Illustration II-Win 3 Units

Term hours: 36 lecture and 72 laboratory TBA. This course is intended for the graphic designer, illustrator and fine artist, focusing on the advanced usage of several 2D vector based drawing software packages. The course focuses on the advanced usage of Windows generation of Postscript (vector) images for integration into desktop publishing/page layout software and as stand-alone images allowing high-resolution output. The course offers the professional artist advanced Windows skills needed for employment and/or advancement. \$20.00 Material Fee - Payable at Registration. (CSU)

MAD 116 C Graphic Design I 3 Units

Formerly ART 140 C.

Term hours: 36 lecture and 72 laboratory TBA. This is a basic course in advertising/graphic design, with emphasis on problem solving in lettering, typography, and trademark design. It includes development of concept development, layout, and presentation skills. Projects include lettering design, layout, trademark design, and typography. Students are introduced to non-electronic and electronic design techniques. Materials fees are for materials provided by the department. \$25.00 Material Fee - Payable at Registration. (CSU)

MAD 117 C Graphic Design II 3 Units

Formerly MAD 144 C

Prerequisite: MAD 116 C.

Term hours: 36 lecture and 72 laboratory. This is an intermediate course in advertising/graphic design with emphasis upon development of a highly comprehensive finished portfolio. Course includes refinement of concept development, layout, and presentation skills. Students refine their non-electronic and electronic design techniques. Material fees for materials are provided by the department. \$25.00 Material Fee - Payable at Registration. (CSU)

MAD 118 C Graphic Design 3 3 Units

Formerly MAD 145 C

Prerequisite: MAD 117 C with a minimum grade of "C".

Term hours: 36 lecture and 72 laboratory. This is an advanced course in advertising/graphic design with an emphasis upon development of comprehensive finished portfolio pieces. This course includes group and individual design projects planned to provide experience in all steps of graphic design from concepts and development of a campaign continuity to production specifications. Special attention and emphasis is placed on planning and preparation of an advertising/graphic portfolio. Materials fees for materials are provided by the department. \$25.00 Material Fee - Payable at Registration. (CSU)

MAD 119 C Multimedia Mobile Design 3 Units

Term hours: 36 lecture and 72 laboratory TBA. This class is designed to introduce the student to the various disciplines involved in the creation of multimedia products including evolving mobile platforms. These disciplines include, computer graphics and visual design, web based content creation, digital photography, video recording, video editing, digital illustration and animated content. \$20.00 Material Fee - Payable at Registration. (CSU)

MAD 120 C 3D Modeling-Mac 3 Units

Term hours: 36 lecture and 72 laboratory TBA. This course focuses on computer generated 3D design techniques through the use of Macintosh based three-dimensional design programs. The course emphasis is on the introduction of three-dimensional concepts, the use of modeling tools, menu structures and modeling building applications of 3D design systems. Skills taught in this course will give students the ability to create original three-dimensional computer generated models of organic or mechanical design and animate them. \$20.00 Material Fee - Payable at Registration. (CSU)

MAD 121 C 3D Modeling-Win 3 Units

Term hours: 36 lecture and 72 laboratory TBA. This course focuses on computer generated 3D design techniques through the use of Windows based three-dimensional design programs. The course emphasis is on the introduction of three-dimensional concepts, the use of modeling tools, menu structures and modeling building applications of 3D design systems. Skills taught in this course will give students the ability to create original three-dimensional computer generated models of organic or mechanical design and animate them. \$20.00 Material Fee - Payable at Registration. (CSU)

MAD 132 C Electronic Paint-Mac 3 Units

Term hours: 36 lecture and 72 laboratory TBA. The course focus is on the usage of Macintosh based software using a variety of natural-media software for the manipulation of bit-mapped (raster) images. Course topics include creation of original drawings; paintings and illustrations, using an assortment of digitally based chalks, pens, paints, inks, papers and textures. The course offers the professional artist raster based digital drawing/painting and illustration skills, on a Macintosh computer, needed for employment and/or advancement. \$20.00 Material Fee - Payable at Registration. (CSU)

MAD 133 C Electronic Paint-Win 3 Units

Term hours: 36 lecture and 72 laboratory TBA. The course focus is on the usage of Microsoft Windows based software using a variety of natural-media software for the manipulation of bit-mapped (raster) images. Course topics include creation of original drawings; paintings and illustrations, using an assortment of digitally based chalks, pens, paints, inks, papers and textures. The course offers the professional artist raster based digital drawing/painting and illustration skills, on a Windows computer, needed for employment and/or advancement. \$20.00 Material Fee - Payable at Registration. (CSU)

MAD 134 C Digital Imaging-Mac 3 Units

Term hours: 36 lecture and 72 laboratory TBA. The course focus is on the usage of Macintosh based software for the manipulation of bit-mapped (raster) images using illustrative, photographic, scanned and video images as the basis for image manipulation. Course topics include image enhancement, editing, composite, retouching, photo montages, prepress, color separations and web based images. \$20.00 Material Fee - Payable at Registration. (CSU)

MAD 135 C Digital Imaging-Win 3 Units

Term hours: 36 lecture and 72 laboratory TBA. The course focus is on the usage of Microsoft Windows based software for the manipulation of bit-mapped (raster) images using illustrative, photographic, scanned and video images as the basis for image manipulation. Course topics include image enhancement, editing, composite, retouching, photomontages, prepress, color separations and Web based images. \$20.00 Material Fee - Payable at Registration. (CSU)

MAD 136 C Digital Imaging II-Mac 3 Units

Term hours: 36 lecture and 72 laboratory TBA. The course focus is on the advanced usage of Macintosh based software for the manipulation of bit-mapped (raster) images using illustrative, photographic, scanned and video images as the basis for image manipulation. Course topics include image enhancement, editing, composite, retouching, photo montages, prepress, color separations and web based images. \$20.00 Material Fee - Payable at Registration. (CSU)

MAD 137 C Digital Imaging II-Win 3 Units

Term hours: 36 lecture and 72 laboratory TBA. The course focus is on the advanced usage of Windows based software for the manipulation of bit-mapped (raster) images using illustrative, photographic, scanned and video images as the basis for image manipulation. Course topics include image enhancement, editing, composite, retouching, photo montages, prepress, color separations and web based images. \$20.00 Material Fee - Payable at Registration. (CSU)

MAD 140 C Desktop Publishing I-Mac 3 Units

Term hours: 36 lecture and 72 laboratory TBA. This course focuses on the use of Macintosh software as an Ad-design tool to generate "digital camera ready" page layouts, integrating graphics, illustrations, photographs and text. Emphasis is placed on design of the page, precision and accuracy allowed by the computer, and varied output options for color composites and separations. Course topics include page design, page layout, text editing, font manipulation, importing artwork, prepress tools, spot and color separations. \$20.00 Material Fee - Payable at Registration. (CSU)

MAD 141 C Desktop Publishing I-Win 3 Units

Term hours: 36 lecture and 72 laboratory TBA. This course focuses on the use of Microsoft Windows software as an Ad-design tool to generate "digital camera ready" page layouts, integrating graphics, illustrations, photographs and text. Emphasis is placed on design of the page, precision and accuracy allowed by the computer, and varied output options for color composites and separations. Course topics include page design, page layout, text editing, font manipulation, importing artwork, prepress tools, spot and color separations. \$20.00 Material Fee - Payable at Registration. (CSU)

MAD 142 C Desktop Publishing II-Mac 3 Units

Term hours: 36 lecture and 72 laboratory TBA. This course focuses on the intermediate use of Macintosh software as an Ad-design tool to generate page layouts, integrating graphics, illustrations, photographs and text. Emphasis is placed on the design of multi-page layout for various types of publications, prepress, color separation and providing "digital camera ready" files for commercial projects. \$20.00 Material Fee - Payable at Registration. (CSU)

MAD 143 C Desktop Publishing II-Win 3 Units

Term hours: 36 lecture and 72 laboratory TBA. This course focuses on the intermediate use of Windows software as an Ad-design tool to generate page layouts, integrating graphics, illustrations, photographs and text. Emphasis is placed on the design of multi-page layout for various types of publications, prepress, color separation and providing "digital camera ready" files for commercial projects. \$20.00 Material Fee - Payable at Registration. (CSU)

MAD 145 C Graphic Design 3 3 Units

Formerly ART 142 C

Prerequisite: MAD 144 C with a minimum grade of "C".

Term hours: 36 lecture and 72 laboratory. This is an advanced course in advertising/graphic design with an emphasis upon development of comprehensive finished portfolio pieces. This course includes group and individual design projects planned to provide experience in all steps of graphic design from concepts and development of a campaign continuity to production specifications. Special attention and emphasis is placed on planning and preparation of an advertising/graphic portfolio. Materials fees for materials are provided by the department. \$25.00 MATERIALS FEE -- PAYABLE AT REGISTRATION. (CSU)

MAD 146 C Desktop Publishing III-Mac 3 Units

Term hours: 36 lecture and 72 laboratory TBA. This course focuses on the advanced use of Macintosh based software as an Ad-design tool to generate digital "camera ready" page layouts, integrating graphics, illustrations, photographs and text. Emphasis on computer assisted layout, design and production techniques used in a "hands on" environment to create Visions magazine. \$20.00 Material Fee - Payable at Registration. (CSU)

MAD 147 C Desktop Publishing III-Win 3 Units

Term hours: 36 lecture and 72 laboratory TBA. This course focuses on the advanced use of Windows based software as an Ad-design tool to generate digital "camera ready" page layouts, integrating graphics, illustrations, photographs and text. Emphasis on computer assisted layout, design and production techniques used in a "hands on" environment to create Visions magazine. \$20.00 Material Fee - Payable at Registration. (CSU)

MAD 150 C Intermediate Animation-Mac 3 Units

Term hours: 36 lecture and 72 laboratory TBA. The course focuses on intermediate skills in 3D computer modeling and animation with a Macintosh software program that is a standard in the industry. The course focus is on intermediate techniques in modeling, texturing, lighting, motion control, and rendering animations for various purposes. Skills taught in this course will give students the ability to create original three-dimensional computer generated models of intermediate organic or mechanical design with a high degree of realism and resolution. Animation techniques explored will provide cinematic realism and presentation. \$20.00 Material Fee - Payable at Registration. (CSU)

MAD 151 C Intermediate Animation-Win 3 Units

Term hours: 36 lecture and 72 laboratory TBA. The course focuses on intermediate skills in 3D computer modeling and animation with a Windows software program that is a standard in the industry. The course focus is on intermediate techniques in modeling, texturing, lighting, motion control, and rendering animations for various purposes. Skills taught in this course will give students the ability to create original three-dimensional computer generated models of intermediate organic or mechanical design with a high degree of realism and resolution. Animation techniques explored will provide cinematic realism and presentation. \$20.00 Material Fee - Payable at Registration. (CSU)

MAD 156 C Advanced Animation-Mac 3 Units

Term hours: 36 lecture and 72 laboratory TBA. The course focuses on advanced skills in 3D computer modeling and animation with a Macintosh software program that is a standard in the industry. The course focus is on advanced techniques in modeling, texturing, lighting, motion control, and rendering animations for various purposes. Skills taught in this course will give students the ability to create original three-dimensional computer generated models of advanced organic or mechanical design with a high degree of realism and resolution. Animation techniques explored will provide cinematic realism and presentation. The course will combine 3D modeling and animation with 2D graphics imagery through mapping, editing techniques and visual effects. \$20.00 Material Fee - Payable at Registration. (CSU)

MAD 157 C Advanced Animation-Win 3 Units

Term hours: 36 lecture and 72 laboratory TBA. The course focuses on advanced skills in 3D computer modeling and animation with a Windows software program that is a standard in the industry. The course focus is on advanced techniques in modeling, texturing, lighting, motion control, and rendering animations for various purposes. Skills taught in this course will give students the ability to create original three-dimensional computer generated models of advanced organic or mechanical design with a high degree of realism and resolution. Animation techniques explored will provide cinematic realism and presentation. The course will combine 3D modeling and animation with 2D graphics imagery through mapping, editing techniques and visual effects. \$20.00 Material Fee - Payable at Registration. (CSU)

MAD 162 C Multimedia Web Design-Mac 3 Units

Term hours: 36 lecture and 72 laboratory TBA. The course focuses on the Macintosh generation of multi-media content for integration into interactive visual presentations with a primary focus on web publishing. Students will create personal interactive presentations by using drawings, photographs, charts, graphs, sound, text and 2D animation. The final presentations will use various outputs including Web, CD, DVD and video. The course offers the professional artist Macintosh multimedia skills needed for employment and/or advancement. \$20.00 Material Fee - Payable at Registration. (CSU)

MAD 163 C Multimedia Web Design-Win 3 Units

Term hours: 36 lecture and 72 laboratory TBA. The course focuses on the Windows generation of multi-media content for integration into interactive visual presentation. Students will create personal interactive presentations by using drawings, photographs, charts, graphs, sound, text and 2D animation. The final presentations will use various outputs including Web, CD, videotape, color and black and white laser printers etc. The course offers the professional artist Windows multimedia skills needed for employment and/or advancement. \$20.00 Material Fee - Payable at Registration. (CSU)

MAD 164 C Adobe Flash Designer-Mac 3 Units

Term hours: 36 lecture and 72 laboratory TBA. The course focuses on the advanced usage of Adobe Flash for Macintosh generated multi-media content for integration into interactive visual presentations. Students will create advanced personal interactive presentations for WEB, CD-ROMs, and video display. Current software and hardware tools and techniques for designing and programming interactive multimedia presentations will be explored using Adobe Flash. The course offers the professional artist advanced Macintosh multimedia skills needed for employment and/or advancement. \$20.00 Material Fee - Payable at Registration. (CSU)

MAD 165 C Adobe Flash Designer-Win 3 Units

Term hours: 36 lecture and 72 laboratory TBA. The course focuses on the advanced usage of Adobe Flash for Windows generated multi-media content for integration into interactive visual presentations. Students will create advanced personal interactive presentations for WEB, CD-ROMs, and video display. Current software and hardware tools and techniques for designing and programming interactive multimedia presentations will be explored using Adobe Flash. The course offers the professional artist advanced Windows multimedia skills needed for employment and/or advancement. \$20.00 Material Fee - Payable at Registration. (CSU)

MAD 179 C The Film Business-Conception to Exhibition 3 Units

Term hours: 54 lecture. This comprehensive and unique course will provide the Film/Media student with the actual tools to parallel their creative vision with the proper marketing strategies to succeed in the Film/Media business. This course will focus on the parallel businesses of film production and Film Distribution/Exhibition as the film making progress moves along. (CSU)

**MAD 180 C Video Editing-Mac 3 Units**

Term hours: 36 lecture and 72 laboratory TBA. The course includes the study and hands-on use of computers, assorted hardware, software, media recorders, and other tools and techniques used for editing and composition of video and audio sources. The course is to provide a thorough introduction to the world of digital video editing used in the fields of multimedia, digital cinema, web based streaming video and mobile video distribution. \$20.00 Material Fee - Payable at Registration. (CSU)

MAD 181 C Video Editing-Win 3 Units

Term hours: 36 lecture and 72 laboratory TBA. The course includes the study and hands-on use of Windows computers, assorted software, CD-ROMs, videodiscs, and other tools and techniques used for digitizing, editing and composition of video and audio sources. The course is to provide a thorough introduction to the world of desktop video used in the fields of multimedia, video editing (both on line and off line) and the creation of Quicktime movies. \$20.00 Material Fee - Payable at Registration. (CSU)

MAD 182 C Cinematography 3 Units

Term hours: 36 lecture and 72 laboratory TBA. This is a course in digital cinema planning and production taught through hands-on experience, research and video production. Course topics include digital cinema as a distinct form of artistic expression; an investigation of the aesthetic, technological, economic, and social factors that contributed to the evolution of digital cinema; logistics, script development, sound recording, video and sound editing; and methods by which the visual and aural elements may be organized. The roles and responsibilities of the digital cinema artist will be examined, including skills and knowledge required in developing, budgeting, managing, producing, and distributing programs. \$20.00 Material Fee - Payable at Registration. (CSU)

MAD 183 C Preproduction for TV, Video and Film 3 Units

Term hours: 54 lecture. This course prepares students to make a film by teaching the necessary steps leading up to shooting the film in production. Topics covered include script, proposal, treatment, casting, crew, locations, financing, personnel, permits, unions, and talent. (CSU)

MAD 184 C Digital Video Explorations 3 Units

Term hours: 36 lecture and 72 laboratory TBA. This course focuses on the experimental use of digital video and audio programs. This course is designed for students to input, create, manipulate and output experimental digital video. This class is intended as a gateway into the varied offerings of the Digital Cinema program, where the student can pursue more in-depth study on the topic(s) that most attracted them during this introductory class. \$20.00 Materials Fee - Payable at Registration. (CSU)

MAD 185 C Documentary Digital Cinema 3 Units

Term hours: 36 lecture and 72 laboratory TBA. This course provides an introduction to contemporary documentary filmmaking techniques used by digital cinema technicians and artists. Hands-on demonstration and lecture and group activities present technical and artistic approaches to documentary productions. Students participate in individual and group projects to produce documentary films. \$20.00 Material Fee - Payable at Registration. (CSU)

MAD 186 C Live Event Video and Audio Production 3 Units

Term hours: 36 lecture and 72 laboratory TBA. This course is designed to introduce the student to the aesthetic concepts, basic skills, and techniques used by videographers to create story films. Students will acquire hands on knowledge of Digital Cinema applications and hardware used in live event videography. \$20.00 Material Fee - Payable at Registration. (CSU)

MAD 187 C Motion Graphics II 3 Units

Term hours: 36 lecture and 72 laboratory TBA. Advanced studies in motion graphics design and software. Topics include both technical and aesthetic issues for motion graphic composition and implementation. Students concentrate on one area to explore in depth and further develop their skills. Production workflow is emphasized. Current trends and styles are discussed. \$20.00 Material Fee - Payable at Registration. (CSU)

MAD 188 C Beginning Single Camera Prod 3 Units

Term hours: 36 lecture and 72 laboratory TBA. The course provides an introduction to the theory, terminology, and operation of single camera video production, including composition and editing techniques, camera operation, portable lighting, video recorder operation, audio control and basic editing. This course focuses on the aesthetics and fundamentals of scripting, producing, directing on location, postproduction, and exhibition/distribution. \$20.00 Material Fee - Payable at Registration. (CSU, C-ID: FTVE 130)

MAD 189 C Cinematography II 3 Units

Term hours: 36 lecture and 72 laboratory TBA. This is an advanced course in digital cinema design and production planning taught through hands-on experience, research and video production. Course topics include digital cinema as a new media tool; synthetic lighting, technological advances in cinematography and emerging tools and techniques. \$20.00 Material Fee - Payable at Registration. (CSU)

MAD 190 C Contemporary Art Studio 3 Units

Term hours: 36 lecture and 72 laboratory. This is a course in contemporary art making with a special emphasis on new genres and technology-based media, including projects in digital media, installation, performance, video, interdisciplinary media, and other nontraditional media and processes. The course will include lectures, discussions, field trips, and projects that address contemporary art and technology topics. (UC/CSU)

MAD 191 C Film Noir Genre 3 Units

Advisory ENGL 100 C.

Term hours: 54 lecture. This course is an in depth exploration of Film Noir. The film genre identified by its crime melodramas where private investigators, innocents and deceptive characters live in a world of corruption, betrayal, obsession, intense romantic trysts and sudden violence. Films will be screened from this period in cinema which began in the early 1940's and continued to the late 1950's with echoes of the genre emerging up to the present. (UC/CSU)

MAD 192 C Great Directors of Cinema 3 Units

Advisory: ENGL 100 C.

Term hours: 54 lecture. A study of historically and aesthetically important film directors focusing on how their work has advanced and defined the art of cinema. The course will explore various directors in terms of themes, stylistic tendencies including use of cinematography tools and social/historical context. (UC/CSU)

MAD 193 C Introduction to 2D Animation 3 Units

Term hours: 36 lecture and 72 laboratory TBA. An introduction to 2D animation production including classical character animation and non-traditional techniques. The class will explore traditionally drawn and emerging digital animation techniques and technology. \$20.00 Materials Fee - Payable at Registration. (CSU)

MAD 194 C Beginning Motion Picture Prod 3 Units

Term hours: 36 lecture and 72 laboratory TBA. This course provides an introduction to the theory, terminology, and process of motion picture production for film and television. Topics include basic cinematography including the operation, function and creative uses of production and post-production equipment, scriptwriting, camera operation, shot composition, lighting, sound recording and mixing, and editing. \$20.00 Materials Fee - Payable at Registration. (CSU, C-ID: FTVE 150)

MAD 195 C Science Fiction Film Genre 3 Units

Advisory: ENGL 100 C.

Term hours: 54 Lecture. This course is an in depth exploration of the Science Fiction Film Genre. The genre is identified by speculative science based narratives which may include time travel, aliens, robots and other futuristic elements. Science fiction films have been used to explore political and social issues as well as human condition. A primary focus of this class is the analysis of technical advancements in film production and cinematic techniques and styles present in the genre. Students will be required to obtain and view films from a provided list. (UC/CSU)

MAD 196 C Silent Film Genre 3 Units

Advisory: ENGL 060 C.

Term hours: 54 lecture. This course is an in depth exploration of Silent Film Genre. The film genre identified as the first attempt at narrative storytelling using the film medium was popularized during the first three decades of the 20th Century. The course covers the history, technology and productions from the original silent era and continues into the contemporary era where silent film has experienced a rebirth. (UC/CSU)

MAD 197 C Western Film Genre 3 Units

Advisory: ENGL 100 C.

Term hours 54 lecture. This course is an in depth exploration of the Western Film Genre which originated in the United States. The film genre is identified by its heroes and villains struggling for control of the American frontier and conquest over the wilderness. Films will be screened from this period in cinema which began in the silent era and continue to the present. A focus will be placed on the technological advances in film production and cinematic styles that have influenced contemporary films. (UC/CSU)

MAD 199 C Computer Graphics Studio .5 to 10 Units

Term hours: 27-540 laboratory depending on units attempted. This course is designed as an open laboratory for students currently enrolled in Fine Arts Division courses that require completion of digital assignments and/or personal digital portfolio development. This open lab with flexible hours is designed to provide students with space, computers, software, scanners, cameras, printers, and internet access. May be taken for a cumulative total of 10 units. Open Entry/Open Exit. Pass/No Pass. (CSU)

MAD 200 C Storyboarding, Comics, Pre Visual 3 Units

Advisory: ART 120 C.

Term hours: 36 lecture and 72 laboratory. Fundamentals of sequential art including: Storyboards, comics, and visual development. Emphasis on Story structure, camera shots, drawing and painting for comics, film/animation and the language of film/story boarding and including concept development and design of storyboards. Exploration of storyboard applications for new media content. \$20.00 Material Fee - Payable at Registration. (CSU)

MAD 295 C Media Arts Design Internship 1 to 4 Units

Term hours: 18-72 lecture. This course is an exploration of internship opportunities in the field of media arts including, graphic design, 2D/3D modeling & animation, motion picture production, video production, computer graphics, visual effects and web design and Internet distribution of content. Pass/No Pass/Letter Grade Option (CSU)

MAD 298 C MAD Seminar .5 to 12 Units

Prerequisite: May be required.

Corequisite: May be required.

Advisory: May be required.

Term hours: 0-216 lecture and/or 0-648 laboratory depending on units attempted. Various classes may be offered from semester to semester which are designed to meet the interests and needs of the students. Fee: May be required-Payable at Registration. May be taken for credit 1-4 times. Pass/No Pass or Pass/No Pass/Letter Grade Option or Standard Letter Grade. (CSU)

Merchandising

Division of Business and Computer Information Systems

Division Dean — Henry Hua

Faculty

Kathleen Pinckard

Counselor

Robert Grantham

ASSOCIATE IN SCIENCE DEGREE

MERCHANDISING **Program Code: 1S07814**

This curriculum is designed to prepare students for careers in merchandising and retailing, learning the necessary techniques to display and sell merchandise, satisfy customers and enhance business profitability.

To earn an Associate Degree students must complete: (1) all major course requirements with a minimum grade of “C”; (2) 25 units of General Education Graduation Requirements; (3) the cultural diversity and reading requirement; (4) any elective courses to complete a minimum of 60 units; and, (5) have a minimum GPA of 2.0. At least 50% of all major course work must be completed at Cypress College.

Courses that fulfill major requirements for an Associate Degree at Cypress College might not be the same as those required for completing the major at a transfer institution offering a Baccalaureate Degree. For information on specific university requirements, please consult with your counselor, or visit the Transfer Center.

Required courses are listed in suggested sequence:

| Course # | Title | Units |
|-----------------------------|-----------------------------|-----------|
| MGT 161 C | Introduction to Business | 3 |
| MKT 210 C | Consumer Behavior | 3 |
| MKT 103 C | Principles of Advertising | 3 |
| MKT 208 C | Principles of Selling | 3 |
| MKT 222 C | Principles of Marketing | 3 |
| MKT 105 C | Principles of Retailing | 3 |
| MGT 266 C | Human Relations in Business | 3 |
| Total Units Required | | 21 |

Additional Recommended Course Work (not required)

| | | |
|-----------|-----------------------------------|---|
| MGT 151 C | Business Mathematics | 3 |
| MGT 261 C | Small Business Management | 3 |
| MGT 265 C | Social Responsibility of Business | 3 |
| MGT 041 C | Survey of Business Law | 3 |

MERCHANDISING CERTIFICATE

Program Code: 1C21099

Primary emphasis is to prepare the student to work in the merchandising and retailing field with a focus on building positive customer relationships.

To earn a certificate, students must complete the required courses as listed with a minimum grade of “C.” At least 50% of all course work must be completed at Cypress College.

Required courses are listed in suggested sequence:

| Course # | Title | Units |
|-----------------------------|-----------------------------|-----------|
| MGT 161 C | Introduction to Business | 3 |
| MKT 208 C | Principles of Selling | 3 |
| MKT 105 C | Principles of Retailing | 3 |
| MKT 210 C | Consumer Behavior | 3 |
| MKT 222 C | Principles of Marketing | 3 |
| MKT 103 C | Principles of Advertising | 3 |
| MGT 266 C | Human Relations in Business | 3 |
| Total Units Required | | 21 |

MERCHANDISING TRANSFER PROGRAM

Refer to Catalog under BUSINESS ADMINISTRATION TRANSFER PROGRAM

Students should consult a counselor or www.assist.org for lower division major requirements for most California public universities. (See the Standard Definitions section of the catalog for a description of ASSIST.) Students transferring to an independent college/university should consult the catalog of the individual school and a counselor for lower division major requirements.

Mortuary Science

Division of Health Science

Division Dean, Interim — Rebecca Gomez

Faculty

Glenn Bower

Damon de la Cruz

Jolena Grande

Dave McCament

Counselors

Kelly Carter

Denise Vo

Doreen Villaseñor

PROGRAM LEARNING OUTCOMES (PLOs)

Mortuary Science

A student who completes the Mortuary Science program will be able to:

- Enlarge the background and knowledge of students desiring to enter the funeral service profession.
- Educate students in every phase of funeral service, and to help them to develop proficiency and skills necessary for the profession.
- Educate students concerning the responsibilities of the funeral service profession to the community at large.
- Emphasize high standards of ethical conduct.
- Provide a curriculum at the post-secondary level of instruction.
- Encourage student and faculty research in the field of funeral service.
- Qualify students for professional licensure examination.

Mortuary Science Program Aims

The Mortuary Science Program at Cypress College has as its central aim recognition of the importance of funeral service personnel as:

1. Members of a human services profession;
2. Members of the community in which they serve;
3. Participants in the relationship between bereaved families and those engaged in the funeral service profession;
4. Professionals knowledgeable of and compliant with federal, state, provincial/territorial and local regulatory guidelines in the geographic area where they practice; as well as
5. Professionals sensitive to the responsibility for public health, safety and welfare in caring for human remains.

MORTUARY SCIENCE PROGRAM OBJECTIVES

1. To enlarge the background and knowledge of students about the funeral service profession;
2. To educate students in every phase of funeral service, and to help enable them to develop the proficiency and skills necessary in the profession, as defined in the Preamble at the beginning of Chapter 9 of the Manual on Accreditation;
3. To educate students concerning the responsibilities of the funeral service profession to the community at large;
4. To emphasize high standards of ethical conduct;
5. To provide a curriculum at the post-secondary level of instruction;
6. To encourage student and faculty research in the field of funeral service; and
7. To qualify students for professional licensure examinations.

MINIMUM STANDARDS FOR APPLICANTS

1. Eligibility for admission to Cypress College.
2. Official High school transcripts, a GED test with a minimum score of 450 on the five-test battery, or high school proficiency examination.
3. Present evidence of good physical and mental health.
4. Completion of College Writing (ENGL 100 C) with the grade of “C” or better.
5. Completion of college Anatomy and Physiology (BIOL 210 C) or General Human Anatomy (BIOL 231 C) with a grade of “C” or better within the most recent 5 year time period prior to program application.
6. Completion of Intermediate Algebra (MATH 040 C) or higher with a grade of “C” or better.
7. A minimum GPA of 2.0 in all college courses attempted.

APPLICATION PROCEDURES

1. In addition to the Cypress College application form, a separate application is required for admission into the Mortuary Science Program. Applications must be completed **online**. Please see the **Health Science Application link** on the Mortuary Science home page.
2. A total of 30 new students are selected each spring and fall semester. Applicants may exceed the available seat space.
3. Applicants are responsible for submitting all documents (records, forms and transcripts) to the Health Science Counseling Office indicating minimum standards and prerequisites have been met.
4. All Official transcripts are required (high school and college).

SELECTION PROCEDURES

Students will be selected using a point system based on the number of general education/graduation courses completed at the time of application. Selection of students for acceptance is based on the **date** of completed application which includes submission of **all** transcripts and required documents.

Mortuary Science Program Accreditation Statement

The Mortuary Science Program at Cypress College is accredited by the American Board of Funeral Service Education (ABFSE) 992 Mantua Pike, Suite 108, Woodbury Heights, NJ 08097 (816) 233-3747. Web: www.abfse.org; Scholarship and general program information can be found on the ABFSE website. The National Board Examination is written and governed by the International Conference of Funeral Service Examining Boards, Inc. (ICFSEB), 1885 Shelby Lane, Fayetteville, AR, 73704, (479) 442-7076, www.theconferenceonline.org; Study guide and preparatory information can be found on the ICFSEB website.

National Board Examination pass rates, graduation rates, (beginning in 2015) and employment rates (beginning in 2015) for this and other ABFSE-accredited programs are available at www.abfse.org. To request a printed copy of this program’s pass rates and rates, go to the Mortuary Science Office, Room 215, Technical Education III Building – Health Science Division or by e-mail at mortsci@CypressCollege.edu, or by telephone (714) 484-7278.

| National Board Exam Statistics | | | |
|--------------------------------|---------------|----------------|--------------|
| Year | No. of Takers | No. Who Passed | % Who Passed |
| 2014 Arts | 28 | 27 | 96% |
| 2014 Science | 28 | 27 | 96% |
| 2015 Arts | 40 | 38 | 95% |
| 2015 Science | 40 | 37 | 93% |
| 2016 Arts | 29 | 27 | 93% |
| 2016 Science | 29 | 28 | 97% |

Program Information

| Year | Total Enrolled | No. of New Students | No. of Grads | Timely Grad* | Graduation Rate | Did Not Finish** | Overall % Employed | Employed in FS |
|------|----------------|---------------------|--------------|--------------|-----------------|------------------|--------------------|----------------|
| 2016 | 102 | 55 | 29 | 22/29 | 53% | 7 | 90% | 62% |
| 2015 | 71 | 64 | 43 | 35/43 | 90% | 9 | 90% | 96% |
| 2014 | 85 | 38 | 30 | 23/30 | 79% | 7 | 100% | 80% |

*Timely graduation = complete program in 1½ times designated program length.

**Left before completing the program; did not finish.

National Board Statistics

| 3 Year Average | % Pass Arts | % Pass Sciences |
|----------------|---------------|-----------------|
| 2016 – 2014 | 95% | 95% |
| 2015 – 2013 | 96% | 97% |
| 2014 – 2012 | 93% | 97% |
| Most Recent | No. of Takers | No. Who Passed |
| 2016 Arts | 29 | 27 |
| 2016 Sciences | 29 | 28 |

ASSOCIATE IN SCIENCE DEGREE IN MORTUARY SCIENCE Program Code: 1S03791

This program is a course of study designed for students who wish to prepare for a career and employment as an embalmer/funeral director in a mortuary and to prepare the student for state licensure where statutory law requires successful completion of the Associate in Science Degree in Mortuary Science and compliance with statutory pre-mortuary science educational requirements. All students completing the Mortuary Science Program curriculum after January 1, 2006, must complete the Associate in Science Degree in Mortuary Science.

The Associate in Science Degree in Mortuary Science at Cypress College is accredited by the American Board of Funeral Service Education (ABFSE), 992 Mantua Pike, Suite 108, Woodbury Heights, NJ 08097, (816) 233-3747, www.abfse.org, and meets the mortuary science or funeral service educational requirements for most states. Eligibility to write the licensure examination in some states may be contingent upon compliance with additional statutory requirements. Please consult the department for more specific information, or, for further information, contact a Health Science Counselor (714) 484-7270.

To earn the Associate in Science Degree in Mortuary Science, students must complete: (1) all major course requirements with a minimum grade of "C"; (2) 25 units of General Education Graduation Requirements; (3) take the National Board Examination (4) the cultural diversity and reading requirements; (5) any elective courses to complete a minimum of 60 units; and, (6) have a minimum GPA of 2.0 in all college level courses attempted and at least 50% of all major course work must be completed at Cypress College.

To be eligible to write the National Board Examination, the student must complete the Associate in Science Degree in Mortuary Science. The annual passage rate of first-time takers on the National Board Examination (NBE) for the most recent three-year period for this institution and all ABFSE accredited funeral service education programs is posted on the ABFSE website (www.abfse.org).

Prerequisites

| | | |
|------------|---|----------|
| ENGL 100 C | College Writing | 4 |
| BIOL 210 C | Anatomy and Physiology or General Human Anatomy | 5 (4) |
| BIOL 231 C | Intermediate Algebra | 4 |
| MATH 040 C | or Combined Algebra I and II | (6) |
| MATH 041 C | | |

Required courses are listed in suggested sequence:

| Course # | Title | Units |
|-----------------------------|--------------------------------|-----------|
| SEMESTER 1 | | |
| MORT 100 C | Orientation to Funeral Service | 3 |
| MORT 163 C | Embalming Anatomy/Pathology I | 4 |
| MORT 164 C | Funeral Service Thanatology I | 2 |
| MORT 165 C | Funeral Service Management I | 3 |
| MORT 170 C | Funeral Service Ceremonies | 3 |
| SEMESTER 2 | | |
| MORT 261 C | Restorative Art I | 2 |
| MORT 262 C | Embalming I | 3 |
| MORT 263 C | Embalming Anatomy/Pathology II | 4 |
| MORT 265 C | Funeral Service Management II | 3 |
| MORT 274 C | Funeral Service Thanatology II | 3 |
| MORT 275 C | Mortuary Law I | 3 |
| SEMESTER 3 | | |
| MORT 271 C | Restorative Art II | 2 |
| MORT 272 C | Embalming II | 3 |
| MORT 285 C | Mortuary Law II | 3 |
| MORT 292 C | Funeral Service Science | 3 |
| MORT 297 C | Mortuary Computer Applications | 2 |
| MORT 294 C | Funeral Service Counseling | 4 |
| Total Units Required | | 50 |

GENERAL EDUCATION GRADUATION REQUIREMENTS

| | |
|---|-----------|
| Categories A through E (see listing earlier in catalog) | 25 |
| Cultural Diversity/Reading Proficiency | |
| Total Units Required | 75 |

MORT 297 C must be taken in the last semester of the ASMS Degree Program prior to graduation.

Mortuary Science (MORT)

MORT 085 C Work Experience 1 to 4 Units

Prerequisite: Admission to Mortuary Science Program. Must be enrolled in seven units or more in the Mortuary Science Program, including work experience.

Term hours: 18 lecture and 80-360 related employment in an approved funeral establishment. This course focuses on exploring work related issues in a funeral establishment of the student's own selection. Discussion of funeral service business and related technical issues are explored. The course includes job analysis, writing a resume, self-management, self-development and employer-employee relations. May be taken for credit 4 times.

MORT 100 C Orientation to Funeral Service 3 Units

Formerly MORT 160 C

Prerequisite: Admission to the Mortuary Science Program.

Term hours: 45 lecture and 27 laboratory. This course is designed to acquaint the mortuary science student with general information on the practice of the funeral profession. Topics covered include: notification of death, transfer of remains, the arrangement conference, prefunded/preplanned funerals, shipment of remains, cremation, and aftercare, as well as the basic principles of merchandising as it applies to the funeral profession, construction and features of caskets, outer burial containers, and other funeral related products; and methods of display and presentation. In addition, the progression of associations and education within funeral service will be discussed. Field trip may be required not to exceed \$50. (CSU)

MORT 153 C Funeral Service Pathology I 3 Units

Prerequisite: Admission to the Mortuary Science Program.

Term hours: 54 lecture. This introductory course designed for the mortuary science student, surveys general anatomical, physiological and pathological concepts processes and terminology important to the funeral service practitioner in understanding the embalming process, articulating with allied health/forensic professionals, interpreting death certificates and protecting oneself and the public against communicable disease. Also considered are those medical and forensic pathologies presenting particular embalming and restorative problems. Field trips may be required not to exceed \$50. (CSU)

MORT 163 C Embalming Anatomy/Pathology I 4 Units

Prerequisite: Admission to Mortuary Science Program.

Term hours: 72 lecture. This introductory course is designed for the mortuary science student, surveys general anatomical, physiological and pathological concepts processes and terminology important to the funeral service practitioner in understanding the embalming process, articulating with allied health/forensic professionals, interpreting death certificates and protecting oneself and the public against communicable disease. Also considered are those medical and forensic pathologies presenting particular embalming and restorative problems. (CSU)

MORT 164 C Funeral Service Thanatology I 2 Units

Prerequisite: Completion of or concurrent enrollment in MORT 100 C.

Term hours: 36 lecture. This course is an introduction to thanatology, basic psychological terminology and theories. Emphasis is on the study of grief, bereavement, and mourning. The content provides the knowledge required of the funeral director to work effectively with families as a facilitating agent. The needs of the families served are studied in relation to the design and implementation of the funeral rite. (CSU)

MORT 165 C Funeral Service Management I 3 Units

Prerequisite: Completion of, or concurrent enrollment in MORT 100 C.

Term hours: 36 lecture and 54 laboratory. Designed for the mortuary science student, the course is a vocationally oriented survey of funeral service management as it applies to funeral home operations, mortuary management, and financial decision-making. Information presented covers financial statements and their analysis, worksheets, journalizing, receivables, payables, deferrals, and accruals. Inventory costing models, depreciation models, and funeral service payroll accounts are also included. (CSU)

MORT 170 C Funeral Service Ceremonies 3 Units

Prerequisite: Completion of or concurrent enrollment in MORT 100 C.

Term hours: 45 lecture and 27 laboratory. This course is designed to introduce the student to American funeral service practices and procedures in military, fraternal and religious funerals for a complete understanding of all principles and variations involved. Field trips may be required not to exceed \$50.00 (CSU)

MORT 182 C Embalming Theory and Practice 1 Unit

Prerequisite: Completion of or concurrent enrollment in MORT 100 C and MORT 153 C.

Term hours: 18 lecture. This introductory course is designed for the mortuary science student, will survey the theory of embalming application through modern techniques, legal and ethical evaluation of the human remains and examine the art of embalming as seen by historical cultures. Field trips may be required not to exceed \$50.00. (CSU)

MORT 242 C Embalming Application 4 Units

Prerequisite: MORT 182 C and completion of or concurrent enrollment in MORT 253 C.

Term hours: 54 lecture and 54 laboratory. This course is designed for the mortuary science student to collaborate and integrate the theory of embalming with the practical aspects of the science of embalming. Field trips may be required not to exceed \$50. (CSU)

MORT 253 C Funeral Service Pathology II 3 Units

Prerequisite: MORT 153 C.

Term hours: 54 lecture. Designed for the Mortuary Science student, and a continuation of MORT 153 C, the course surveys general anatomical, physiological, and pathological concepts as they relate to the various systems of the human body. The body systems are studied in detail as they relate to preservation and disinfection for safeguard measures in handling and embalming of human remains to protect public health and the embalmer. Throughout the course, terminology is emphasized to facilitate interpretation of death certificates. Field trips may be required not to exceed \$50. (CSU)

MORT 261 C Restorative Art I 2 Units

Prerequisite: Completion of or concurrent enrollment in MORT 263 C.

Term hours: 18 lecture and 54 laboratory. A detailed study is made of each of the facial features and its relationship to a complete restoration. In the laboratory the student has an opportunity to follow through with the modeling in clay and other modeling media of the features studied, both as a single feature and using plaster of Paris heads for reproduction. (CSU)

MORT 262 C Embalming I 3 Units

Prerequisite: Completion of or concurrent enrollment in MORT 263 C.

Term hours: 36 lecture and 54 laboratory. This course is designed to include basic orientation, history of embalming to present times, moral and sanitary considerations of embalming, methods of handling human remains, including those of a contagious or infectious nature, demonstration of the various methods of preparation and disinfection treatment of bodies contaminated by radiation. (CSU)

MORT 263 C Embalming Anatomy/Pathology II 4 Units*Prerequisite: MORT 163 C.*

Term hours: 72 lecture. Designed for the Mortuary Science student, and a continuation of MORT 163 C, the course surveys general anatomical, physiological, and pathological concepts as they relate to the various systems of the human body. The body systems are studied in detail as they relate to preservation and disinfection for safeguard measures in handling and embalming of human remains to protect public health and the embalmer. Throughout the course, terminology is emphasized to facilitate interpretation of death certificates. (CSU)

MORT 264 C Funeral Service Psychology 4 Units*Prerequisite: MORT 100 C.*

Term hours: 72 lecture. This course is an introduction to thanatology, basic psychological terminology and theories. Emphasis is on the study of grief, bereavement and mourning. The content provides the knowledge required of the funeral director to work effectively with families as a facilitating agent. The needs of the families served are studied in relation to the design and implementation of the funeral rite. Field trips may be required not to exceed \$50. (CSU)

MORT 265 C Funeral Service Management II 3 Units*Prerequisite: MORT 100 C and MORT 165 C.*

Term hours: 54 lecture. This course is a continuation of MORT 165 C designed to introduce the mortuary science student to the basic principles of management, merchandising, and effective managerial skills as they apply to the practice of the funeral profession; to the financial aspects of funeral business operation, concepts of financial management and the use of financial information in decision-making relative to cost analysis and control, pricing, inventory and in assessing the firm's performance; and credit policies and practices. (CSU)

MORT 271 C Restorative Art II 2 Units*Prerequisite: MORT 261 C and MORT 263 C.*

Term hours: 18 lecture and 54 laboratory. This is a continuation of MORT 261 C, with emphasis upon major restorations and explains how all previous restorative art work can be used to complete each type of case. Color theory and cosmetology are discussed. In the lab the student will perform feature modeling in wax on both plaster of Paris and latex heads. In addition, there is practical work in cosmetics, hair dressing, color pigments and preparation of death masks. \$140.00 Material Fee-Payable at Registration. (CSU)

MORT 272 C Embalming II 3 Units*Prerequisite: MORT 262 C and MORT 263 C.*

Term hours: 36 lecture and 54 laboratory. This is a continuation of MORT 262 C, with emphasis upon the development of embalming techniques, dead human remains having various diseases, treatment of localized areas by supplemental methods of preservation and the application of embalming theories ranging from pre-embalming analysis to funeral home visitation room appearance, in a laboratory environment. (CSU)

MORT 274 C Funeral Service Thanatology II 3 Units*Prerequisite: MORT 100 C and MORT 164 C and MORT 170 C.*

Term hours: 54 lecture. This course is a continuation of MORT 164 C, with emphasis on the grief process, normal and abnormal, and the resolution of grief. Follow-up programs initiated by the funeral director are examined in detail as well as community support groups with whom the funeral director participates. Major emphasis is placed on the student identifying problem areas in the field, making a plan for intervention, and making appropriate referrals to community professionals. (CSU)

MORT 275 C Mortuary Law I 3 Units*Prerequisite: MORT 100 C and completion of or concurrent enrollment in MORT 265 C.*

Term hours: 54 lecture. This course designed for the Mortuary Science student, surveys the American legal system, its development, and the major bodies of law as they relate to the legal environment in which the funeral business operates. The legal aspects of funeral service contracts, funeral service sales, and the use of commercial paper are also considered. This course will also look at the professional ethics used by funeral service providers as it relates to the legal aspects of the funeral home establishment. (CSU)

MORT 285 C Mortuary Law II 3 Units

Formerly MORT 291 C

Prerequisite: MORT 265 C and MORT 275 C.

Term hours: 54 lecture. This course is a continuation of MORT 275 C designed to introduce the mortuary science student to sources of law, legal status of the dead human body, duty of burial, right to control funeral arrangements, final disposition, and liability for funeral expenses; torts involving the dead human body and the funeral director; wills, estate, and probate proceedings; cemeteries and related issues; state and federal laws and regulations pertaining to funeral service; as well as the legal aspects of being a licensed funeral director/mortician. (CSU)

MORT 292 C Funeral Service Science 4 Units*Prerequisite: Completion of or concurrent enrollment in MORT 272 C.*

Term hours: 54 lecture. This course is designed to familiarize the Mortuary Science student with the nature of chemicals utilized in the mortuary setting, and to provide a qualitative understanding of the chemical aspects of tissue decomposition and preservation. Embalming of protein and the effects relative to the blood, body pigments and tissue staining are a primary emphasis of the course. (CSU)

MORT 294 C Funeral Service Counseling 4 Units*Prerequisite: MORT 274 C.*

Term hours: 54 lecture and 54 laboratory. This is a course aimed at the study of concepts, techniques and procedures used by the funeral director in his/her role as a counselor. Field trip may be required not to exceed \$50. (CSU)

MORT 297 C Mortuary Computer Applications 2 Units

Formerly MORT 293 C

Prerequisite: Completion of all required general education courses and graduation requirements for the Associate in Science Degree Mortuary Science.

Term hours: 18 lecture and 54 laboratory. The course is designed to provide the mortuary science student with an overview of considerations relevant to the operation of the funeral home as a small business through the use of hands-on experience with appropriate mortuary science computer software, as well as the Federal Trade Commission Funeral Rule. \$106.00 Materials Fee - PAYABLE AT REGISTRATION. (CSU)

Mortuary Science Baccalaureate Program Courses

BACHELOR IN SCIENCE DEGREE IN FUNERAL SERVICE Program Code 1B34011

This program is an accredited course of study in funeral service education designed for students who wish to advance their career and employment opportunities as a funeral service practitioner and to prepare the student for state licensure where statutory law requires successful completion of the Bachelor in Science Degree in Funeral Service in order to practice. To earn the Bachelor in Science Degree in Funeral Service, students must complete: (1) requirements for Associate in Science Mortuary Science degree or equivalent; (2) all upper division major course requirements with a minimum grade of "C"; (3) 37 units of IGETC lower division general education coursework or 39 units CSU GE Breadth lower division general education coursework, or previously awarded baccalaureate degree; (4) a minimum of 9 units of Upper Division General Education Graduation Requirements; (5) the cultural diversity requirement; (6) any elective courses to complete a minimum of 120 units; and, (7) have a minimum GPA of 2.0 in all college level courses attempted and at least 24 units of upper division course work must be completed at Cypress College (residency requirement). Total degree units are 120–131 units.

Prerequisite Associate Degree from ABFSE Accredited Funeral Service/Mortuary Science Program (41–50 units in the major)

Acceptance into Baccalaureate degree pilot program and
 Embalmer License
 and
 Funeral Director License
 or
 Funeral Service Practitioner certification

Required upper division major courses (32 units) of which 12 units will be from MORT 497 C and MORT 498 C

| | | |
|---------------------------|---------------------------------------|------------------|
| MORT 402 C | Funeral Service Standards of Practice | 3 |
| MORT 430 C | Cemetery and Crematory Operations | 3 |
| MORT 450 C | Issues and Trends in Funeral Service | 3 |
| MORT 482 C | Clinical Embalming Externship | 4 |
| MORT 492 C | Funeral Service Externship | 4 |
| MORT 495 C | Mortuary Jurisprudence | 3 |
| MORT 497 C and MORT 498 C | | (12 units total) |

| Upper division general education courses | | Units |
|--|--|-----------|
| ANTH 308 C | Anthropology of Death for Mortuary Science | 3 |
| COMM 340 C | Communication for Mortuary Science | 3 |
| ENGL 310 C | Advanced Writing in the Health Sciences | 4 |
| Total Units | | 42 |

ANTH 308 C Anthropology of Death for Mortuary Science 3 Units

Prerequisite: Completion of ENGL 100 C or ENGL 100HC.
 Term hours: 54 lecture. This is an upper division intensive writing course intended only for Cypress College Mortuary Science BDP students. (All other students interested in this course should take ANTH 208 C - Anthropology of Death). This course is a cross-cultural exploration of the beliefs and practices surrounding death, dying, mourning, and mortuary customs, as well as conceptions of the afterlife, in cultures around the world. An integrated anthropological approach will be taken, including data from archaeology, biological anthropology and cultural anthropology.

COMM 340 C Communication for Mortuary Science 3 Units

Prerequisite: ENGL 100 C or ENGL 100HC with minimum grade of "C".
Advisory: COMM 100 C or COMM 100HC.

Term hours: 54 lecture. This course provides an integrative overview of communication for students in Mortuary Science. This course is designed to introduce students to advanced theories and principles of communication and to provide practical applications of those concepts. The course focuses on an in-depth utilization of those concepts in various communication settings.

ENGL 310 C Advanced Writing in the Health Sciences 4 Units

Prerequisite ENGL 100 C or ENGL 100HC.

Term hours: 72 lecture. This course provides an overview of writing for students in health sciences. It will include effective workplace/professional writing and critical evaluation of discipline specific texts. The class will also include research writing, grant writing and appropriate documentation skills. This course is designed for science majors. Enrollment limited to those accepted into the baccalaureate degree pilot program.

MORT 402 C Funeral Service Standards of Practice 3 Units

Prerequisite: Admission into baccalaureate degree pilot program and completion of MORT 297 C.

Term hours: 54 lecture. Designed to provide an integrative approach for ongoing development of critical thinking skills, best practices evaluation, and application of skills based competencies. Students will be challenged to integrate their learning from any previous funeral service, mortuary science or related training and education, past and present work settings as well as life experiences. This process will be facilitated through the development of a professional portfolio, collaborative group learning, class discussions and the use of blended learning approaches. Recommended: This course should be taken as soon as possible upon acceptance into the Baccalaureate Degree Completion Program. Field trips will be required.

MORT 430 C Cemetery and Crematory Operations 3 Units

Prerequisite: Admission to Baccalaureate degree pilot program and completion of or concurrent enrollment in MORT 402 C, and completion of MORT 297 C.

Term hours: 54 lecture. This is advanced course designed for the funeral service practitioner that surveys cemetery and crematory processes necessary with working with a funeral entity as well as examining the legal ramifications and notifications necessary when working with the bereaved families. Field trips will be required. Enrollment limited to those accepted into baccalaureate degree pilot program.

MORT 450 C Issues and Trends in Funeral Service 4 Units

Prerequisite: Admission to Baccalaureate degree pilot program and completion of or concurrent enrollment in MORT 402 C.

Term hours: 54 lecture. Selected current issues of importance to the funeral service industry. Emphasis on issues impacting California funeral service practices. Field trips will be required. Enrollment limited to those accepted into baccalaureate degree pilot program.

MORT 482 C Clinical Embalming Externship  **3 Units**

Prerequisite: Embalmer license and Funeral Director license, or funeral service practitioner certification and completion of or concurrent enrollment in MORT 402 C.

Term hours: 18 lecture and 162 laboratory. This course is designed as a culmination of theory, practical knowledge and applied skills necessary to enhance the dead human remains through the embalming and restoration process. Field Trips may be required not to exceed \$50. Enrollment limited to those accepted into baccalaureate degree pilot program.

MORT 492 C Funeral Service Externship  **4 Units**

Prerequisite: Embalmer license and Funeral Director license, or funeral service practitioner certification and completion of or concurrent enrollment in MORT 402 C.

Term hours: 18 lecture and 162 laboratory. This course is designed as a culmination of theory, practical knowledge and applied skills necessary to enhance memorialization of the dead human remains through the funeralization and disposition process. Field Trips may be required not to exceed \$50. Enrollment limited to those accepted into the Baccalaureate Degree Pilot Program.

MORT 495 C Mortuary Jurisprudence  **3 Units**

Prerequisite: Acceptance into baccalaureate degree pilot program and completion of or concurrent enrollment in MORT 402 C.

Term hours: 54 lecture. This course is a continuation of MORT 285 C and provides the funeral service practitioner with a review of sources of law, state and federal laws and regulations pertaining to funeral service; as well as the legal and ethical aspects of being a licensed cemetery manager and crematory manager. Field trips will be required. Enrollment limited to those accepted into the baccalaureate degree pilot program.

MORT 497 C Funeral Service Practicum I  **2-12 Units**

Prerequisite: Acceptance into baccalaureate degree pilot program upon completion of all required lower division courses and completion of MORT 297 C and completion of or concurrent enrollment in MORT 402 C, MORT 430 C, MORT 450 C and MORT 495 C.

Term hours: 18 lecture and 54-594 laboratory. This course provides practical experience in embalming, funeral directing, cemetery operations, and crematory operations in a mortuary/funeral home, cemetery or crematory environment under the supervision of a licensed funeral service practitioner. It includes active participation in planning and directing of ten or more funerals. This course is one of two capstone courses of the major. It is to be taken only after all other MORT courses have been passed, except co-requisite(s), and is to be taken in the semester prior to graduation. Enrollment limited to those accepted into the baccalaureate degree pilot program.

MORT 498 C Funeral Service Practicum II  **2-12 Units**

Prerequisite: MORT 497 C.

Term hours: 18 lecture and 54-594 laboratory. This course provides practical experience in embalming, funeral directing, cemetery operations, and crematory operations in a mortuary/funeral home, cemetery or crematory environment under the supervision of a licensed funeral service practitioner. It includes active participation in planning and directing of ten or more funerals. This course is one of two capstone courses of the major. It is to be taken only after all other MORT courses have been passed, except co-requisite(s), and is to be taken in the semester prior to graduation. Enrollment limited to those accepted into the baccalaureate degree pilot program.

Multimedia

Division of Fine Arts

Division Dean — Katy Realista

Faculty

Edward Giardina
Ian Holmes
Clifford Lester

Counselors

Renay Laguana-Ferinac
Renee Ssensalo

MULTIMEDIA ART CERTIFICATE

Program Code: 1C12359

The Multimedia Art Certificate Program provides the skills necessary to create interactive projects for distribution on videotape, CD-ROMs, and Websites.

To earn a certificate, students must complete the required major courses as listed with a minimum grade of "C" for each course. At least 50% of all course work must be completed at Cypress College.

Required courses are listed in suggested sequence:

| Course # | Title | Units |
|-----------------------------|---|-----------|
| MM 100 C | Introduction to Electronic Media | 3 |
| JOUR 130 C | Visual Communications | 3 |
| PHOT 101 C | Introduction to Photography | 3 |
| ART 120 C | Two-Dimensional Design | 3 |
| MUS 178 C | Digital Music Technology | 3 |
| MAD 100 C | Introduction to Computer Graphics/Mac or | 3 |
| MAD 101 C | Introduction to Computer Graphics/Win or | (3) |
| MAD 102 C | Introduction to Mac WEB Graphics or | (3) |
| MAD 103 C | Introduction to Win WEB Graphics | (3) |
| MAD 134 C | Digital Imaging/Mac or | 3 |
| MAD 135 C | Digital Imaging/Win | (3) |
| MAD 162 C | Multimedia Web Design/Mac or | 3 |
| MAD 163 C | Multimedia Web Design/Win | (3) |
| MAD 164 C | Adobe Flash Designer/Mac or | 3 |
| MAD 165 C | Adobe Flash Designer/Win | (3) |
| Total Units Required | | 27 |

Multimedia (MM)

MM 100 C Introduction to Electronic Media 3 Units

Term hours: 54 lecture. This course introduces the history, structure, function, economics, content and evolution of radio, television, film, the Internet, and new media, including traditional and mature formats. The social, political, regulatory, ethical and occupational impact of the electronic media are also studied. (CSU)

MM 101 C Introduction to Online Learning 1 Unit

Term hours: 18 lecture. This course prepares the student for the online education experience through direct application of online courseware tools such as chat, discussion, file exchange, homepage, course calendar, online gradebook, and external links. It also explores word processing basics, time management, troubleshooting, electronic mail, e-mail attachments, Internet navigation and research, file transfer protocol and other Internet services. Pass/No Pass/Letter Grade Option. (CSU)

MM 105 C Introduction to Media Aesthetics 3 Units

Advisory: Eligibility for ENGL 100 C.

Term hours: 54 lecture. Introduction to Media Aesthetics and Cinematic Arts introduces the close analysis of film and television texts. Examines the broad questions of form and content, aesthetics and meaning, and history and culture. Explores the diverse possibilities presented by the cinematic art form through an examination of a wide variety of productions, national cinemas, and film movements. Topics include modes of production, narrative and non-narrative forms, visual design, editing, sound, genre, ideology and critical analysis. (CSU)

Music

Division of Fine Arts

Division Dean — Katy Realista

Faculty

Gary Gopar
 Marcus McMillan
 Terra Schwartzwald

Counselors

Renay Laguana-Ferinac
 Renee Ssensalo

PROGRAM LEARNING OUTCOMES (PLOs)

The courses taught by this department contribute to the General Education and Basic Skills Program Learning Outcomes. Please refer to General Education and Basic Skills Program Learning Outcomes.

Music Department

- Given a variety of music materials and subject matter, students will be able to critically analyze the content and creation through composition, process, and music historical context.
- Given a variety of music materials and subject matter, students will be able to discuss the content and creation of music, through composition, process, and music historical context.
- Given a variety of music materials and subject matter, students will be able to identify the content and creation through composition, process, and music historical context.
- Given a variety of music materials and subject matter, students will be able to personalize the social and psychological aspects of the content and creation through composition, process and music historical context.

Course Repeatability Limitations

Effective 2013, most active participatory courses in Art, Dance, Theater, Music, and Kinesiology/Physical Education are no longer repeatable. The courses in the table below are related in content and therefore have been identified in distinct “family” groupings in which students are limited to a maximum of 4 course enrollments per family (withdrawals and substandard grades will be counted towards the 4 enrollment maximum). Note: Exceptions for courses still designated as repeatable are indicated in course descriptions of the college catalog and class schedules with the statement, “May be taken for credit ____ times.” If students are majoring in any of these disciplines, they are advised to see their counselor to discuss options.

| DISCIPLINE | FAMILY/RELATED COURSES | COURSES RELATED IN CONTENT | LIMITATIONS |
|------------------|---|---|--|
| Music | Jazz Voice | MUS 157 C, 229 C | Students are limited to four (4) semester enrollments — in Active Participatory courses — whether in a single course or in a combination of courses grouped within a family. All enrollments in courses (including enrollments in the same repeatable course) within a family count toward the maximum enrollment limitation of four (4) semester enrollments. This includes evaluative (A, B, C, D, F, P, NP) and non-evaluative (I, IP, RD, and W) grades earned. All letter grades received will be counted in GPA. |
| | Classical Instrumental | MUS 130 C, 131 C, 143 C, 146 C | |
| Applied Music | Applied Piano | MUSA 130 C, MUS 238 C | |
| | Applied Keyboard | MUSA 131 C, 132 C, 231 C, 232 C | |
| | Applied Concert | MUSA 104 C, 105 C, 106 C, 107 C | |
| | Applied Voice (Classical) | MUSA 111 C, 112 C, 210 C | |
| | Applied Guitar | MUSA 120 C, 121 C, 221 C | |
| Music Exceptions | Courses Maintaining Repeatability CSU, UC Required courses 1 Plus 3 Repeats | MUS 225 C, Music Ensemble Courses: MUS 163 C, 175 C, 260 C, 261 C, 273 C, 274 C, 276 C, 279 C, 280 C, 281 C, 282 C, 283 C, 285 C, 287 C | |

ASSOCIATE IN ARTS IN MUSIC FOR TRANSFER DEGREE (AA-T)

Program Code: 1A32134

This curriculum is designed to provide an opportunity for the Music major to achieve an Associate in Arts in Music for Transfer (AA-T in Music) which completes the first and second year requirements for transfer to a four-year public California institution. While at least a baccalaureate degree is recommended preparation for those considering professional careers, completion of this curriculum will demonstrate commitment to the field and provide comprehensive preparation for further academic study through upper-division course work. This curriculum specifically prepares the prospective transfer student for upper division course work in Music or a similar major at a California State University (CSU) campus. Students should consult a counselor, the Transfer Center and the catalog of the transfer college or university to plan a specific program of study to meet the college or university's requirements.

Note: Courses that fulfill major requirements for an Associate Degree for Transfer at Cypress College might not be the same as those required for completing the major at all transfer institutions offering a Baccalaureate Degree. The Student Transfer Achievement Reform Act (Senate Bill 1440, now codified in California Education Code sections 66746–66749) guarantees admission to a California State University (CSU) campus for any community college student who completes an “associate degree for transfer,” a newly established variation of the associate degrees traditionally offered at a California community college. The AA-T is intended for students who plan to complete a bachelor's degree in a similar major at a CSU campus. Students completing these degrees (AA-T) are guaranteed admission to the CSU system, but not to a particular campus or major. Students transferring to a CSU campus that does accept the AA-T will be required to complete no more than 60 units after transfer to earn a bachelor's degree (unless the major is designated “high-unit” major). This degree may not be the best option for students intending to transfer to a particular CSU campus or to a university or college that is not part of the CSU system. Students should consult with a counselor when planning to complete the degree for more information on university admission and transfer requirements. The completion of this curriculum will demonstrate commitment to the Music field and provide comprehensive preparation for upper-division work.

To earn an AA-T in Music students must complete the following requirements: (1) a minimum of 24 semester units or 36 quarter units in the Music major with a minimum grade of “C”; (2) California State University General Education Breadth requirements (CSU GE Breadth) or the Intersegmental General Education Transfer Curriculum (CSU IGETC); (3) completion of 60 semester or 90 quarter units of CSU transferable course work; and (4) have an overall GPA of 2.0.

| Required core courses (24 units) | | Units |
|----------------------------------|------------------|-------|
| MUS 103 C | Theory I | 3 |
| MUS 104 C | Musicianship I | 1 |
| MUS 105 C | Theory II | 3 |
| MUS 106 C | Musicianship II | 1 |
| MUS 203 C | Theory III | 3 |
| MUS 204 C | Musicianship III | 1 |
| MUS 205 C | Theory IV | 3 |
| MUS 206 C | Musicianship IV | 1 |
| MUS 225 C | Applied Music | 1 |

Students must enroll 4 times, once each semester in MUS 225 C

Students will be required to participate in an Ensemble each semester for 4 semesters.

| | Units | |
|-----------------------------|-----------------------------|-----------|
| MUS 175 C | Swing Band | 1 |
| MUS 273 C | Concert Band | 1 |
| MUS 274 C | Cypress Symphonic Winds | 1 |
| MUS 276 C | Jazz Band | 1 |
| MUS 280 C | Jazz/Musical Theater Choir | 1 |
| MUS 282 C | Cypress Masterworks Chorale | 1 |
| MUS 283 C | Cypress Singers | 1 |
| MUS 285 C | Chamber Singers | 1 |
| MUS 287 C | Vocal Jazz Ensemble | 1 |
| Total Units Required | | 24 |

ASSOCIATE IN ARTS DEGREE MUSIC

Program Code: 1A03777

The Associate in Arts Degree in Music is designed to prepare the student for a career as a professional musician. This curriculum includes music history and theory, as well as applied instruction and performance experience on his or her particular instrument.

To earn an Associate Degree students must complete: (1) all major course requirements with a minimum grade of “C”; (2) 25 units of General Education Graduation Requirements; (3) the cultural diversity and reading requirements; (4) any elective courses to complete a minimum of 60 units; and, (5) have a minimum GPA of 2.0. At least 50% of all major course work must be completed at Cypress College. Courses that fulfill major requirements for an Associate Degree at Cypress College might not be the same as those required for completing the major at a transfer institution offering a Baccalaureate Degree. For information on specific university requirements, please consult with your counselor, or visit the Transfer Center.

| Required courses are listed in suggested sequence: | | Units |
|--|----------------------------------|-------|
| MUS 103 C | Theory I | 3 |
| MUS 104 C | Musicianship I | 1 |
| MUS 105 C | Theory II | 3 |
| MUS 106 C | Musicianship II | 1 |
| MUS 108 C | Introduction to Music Technology | 3 |
| MUS 120 C | Survey of Music History | 3 |
| | or | |
| MUS 116 C | Music Appreciation | (3) |
| MUSA 104 C | Introduction to Concert Hour | 1 |
| MUSA 105 C | Beginning Concert Hour | 1 |
| MUSA 106 C | Intermediate Concert Hour | 1 |
| MUSA 107 C | Advanced Concert Hour | 1 |
| MUSA 131 C | Keyboard Skills I | 1 |
| MUSA 132 C | Keyboard Skills II | 1 |
| MUSA 231 C | Keyboard Skills III | 1 |
| MUSA 232 C | Keyboard Skills IV | 1 |
| MUS 225 C | Applied Music | 1 |

Students must enroll 4 times, once each semester in MUS 225 C

| Select a maximum of 1 unit each semester from the following performing ensembles for a total of 4 units: | | Units |
|--|-----------------------------|-----------|
| MUS 175 C | Swing Band | 1 |
| MUS 260 C | Classical Guitar Ensemble | 1 |
| MUS 261 C | String Ensemble | 1 |
| MUS 273 C | Concert Band | 1 |
| MUS 274 C | Cypress Symphonic Winds | 1 |
| MUS 276 C | Jazz Band | 1 |
| MUS 280 C | Jazz/Musical Theater Choir | 1 |
| MUS 281 C | Concert Choir | 1 |
| MUS 282 C | Cypress Masterworks Chorale | 1 |
| MUS 283 C | Cypress Singers | 1 |
| MUS 285 C | Chamber Singers | 1 |
| MUS 287 C | Vocal Jazz Ensemble | 1 |
| Total Units Required | | 30 |

COMMERCIAL MUSIC MANAGEMENT CERTIFICATE

Program Code: 1C12951

A synthesis of Music and Business courses, this certificate enables students to develop the management, marketing, and entrepreneurial skills necessary for success in the Music Industry.

To earn a certificate, students must complete the required courses as listed with a minimum grade of “C.” At least 50% of all course work must be completed at Cypress College.

Required courses are listed in suggested sequence:

| Course # | Title | Units |
|-----------------------------|----------------------------------|-----------|
| MUS 111 C | The Music Business | 3 |
| MUS 212 C | Music Promotion and Distribution | 3 |
| MKT 222 C | Principles of Marketing | 3 |
| MGT 261 C | Small Business Management | 3 |
| MGT 266 C | Human Relations in Business | 3 |
| Total Units Required | | 15 |

Additional Recommended Course Work (not required)

| | | |
|-----------|-------------------------|-----|
| MKT 224 C | International Marketing | (3) |
|-----------|-------------------------|-----|

RECORDING ARTS CERTIFICATE

Program Code: 1C12958

This program was developed for prospective record producers, recording engineers, and songwriters, giving an insider’s look at the way music is recorded today. Students will gain hands-on experience in “state of the art” facilities.

To earn a certificate, students must complete the required courses as listed with a minimum grade of “C.” At least 50% of all course work must be completed at Cypress College.

Required courses are listed in suggested sequence:

| Course # | Title | Units |
|-----------------------------|----------------------------------|-----------|
| MUS 101 C | Music Fundamentals | 3 |
| MUS 108 C | Introduction to Music Technology | 3 |
| MUS 124 C | Recording Studio I | 3 |
| MUS 176 C | Popular Songwriting | 3 |
| | or | |
| MUS 177 C | Songwriting Workshop | (3) |
| MUS 222 C | Audio Production for Film I | 3 |
| Total Units Required | | 15 |

MUSIC TRANSFER PROGRAM

Students should consult a counselor or www.assist.org for lower division major requirements for most California public universities. (See the Standard Definitions section of the catalog for a description of ASSIST.) Students transferring to an independent college/university should consult the catalog of the individual school and a counselor for lower division major requirements.

Music (MUS)

MUS 101 C Music Fundamentals **3 Units**

Term hours: 54 lecture. This cross cultural course covers the elements of sound, their application and effect in musical structures. The historical evolution of music, notation, and its understanding and application are presented in an international societal context. It is open to all students Note: No UC credit if taken after MUS 103AC. (UC Credit Limitation/CSU, AA GE, CSU GE, C-ID: MUS 110)

MUS 102 C Music Reading **3 Units**

Term hours: 54 lecture. This course is designed to teach students how to read music from the printed page. Participants will learn basic skills, such as identifying note names and rhythm values, and will progress to the primary levels of sight-singing and developing the inner ear, a skill vital to every musician. (UC/CSU)

MUS 103 C Theory I **3 Units**

Formerly MUS 103AC
Corequisite: MUS 104 C.
Advisory: MUS 101 C or MUSA 131 C. Student should have a practical understanding of music fundamentals, and basic keyboard skills.

Term hours: 54 lecture. This is the first course in music theory for music majors. This course, through guided composition and analysis, incorporates the following concepts: rhythm and meter; basic properties of sound; intervals; diatonic scales and triads; diatonic chords, basic cadential formulas and phrase structure; dominant seventh; figured bass symbols; and non-harmonic tones. Development of skills in handwritten notation is expected. (UC/CSU, AA GE, CSU GE, IGETC, C-ID: MUS 120)

MUS 104 C Musicianship I **1 Unit**

Corequisite: MUS 103 C.
Advisory: MUSA 131 C and MUS 101 C or student should have a practical understanding of music fundamentals, and basic keyboard skills.

Term hours: 18 lecture and 18 laboratory. This course applies and develops the rhythmic, melodic, and harmonic materials of Music Theory I through ear training, sight singing, analysis, and dictation. (UC/CSU, C-ID: MUS 125)

MUS 105 C Theory II **3 Units**

Formerly MUS 103BC
Prerequisite: MUS 103 C with a minimum grade of “C”.
Corequisite: MUS 106 C.
Advisory: MUSA 132 C.

Term hours: 54 lecture. This course incorporates the concepts from Music Theory I. In addition, through guided composition and analysis, the course will include: an introduction to two-part counterpoint; voice leading involving four-part chorale writing; diatonic harmony; and an introduction to secondary/applied chords and modulation. (UC/CSU, C-ID: MUS 130)

MUS 106 C Musicianship II **1 Unit**

Prerequisite: MUS 104 C with a minimum grade of “C”.
Corequisite: MUS 105 C.
Advisory: MUSA 132 C with a minimum grade of “C” or piano proficiency audition.

Term hours: 18 lecture and 18 laboratory. This course applies and develops the rhythmic, melodic, and harmonic materials of Music Theory II through ear training, sight singing, analysis, and dictation. (UC/CSU, C-ID: MUS 135)

MUS 108 C Introduction to Music Technology **3 Units**

Term hours: 36 lecture and 72 laboratory. This course covers the following basic aspects of music technology: computer skills, software-based sequencing, synthesis, MIDI, sampling, notation, principles of sound, microphones, introduction to digital audio, signal processing, mixers and mixing, recording principles, cables and interconnects, and audio in live performance. (CSU)

MUS 111 C The Music Business **3 Units**

Term hours: 54 lecture. From copyrights to contracts, this course covers the essential elements of the music industry for performers, songwriters, producers, and managers. Topics include intellectual property law (copyrights), management contracts, publishing companies, performance rights societies, licensing procedures, record manufacturing and distribution, and an overall look at the dynamics of the music and entertainment industries. Guest speakers will appear according to availability. (CSU)

MUS 113 C Jazz History**3 Units**

Term hours: 54 lecture. This is a survey course which traces the history and development of jazz music from its inception to the present day. The music, both live and from recordings, is studied from a cultural, musical, historical, and sociological standpoint. Concert attendance is required. Open to all students. (UC/CSU, AA GE, CSU GE, IGETC, CUL DIV)

MUS 116 C Music Appreciation**3 Units**

Term hours: 54 lecture. A survey of music literature from the Middle Ages to the present. Students will gain an understanding of music as an art form through listening and discussion of choral, orchestral, solo, opera, chamber and jazz works. Concert attendance is required. Open to all students, but designed for the non-music major. (UC/CSU, AA GE, CSU GE, IGETC, C-ID: MUS 100)

MUS 117 C American Popular Music**3 Units**

Term hours: 54 lecture. A historical and musical study of American popular music from its origin to the present. The primary focus will be on musical styles with secondary emphasis on sociological, political and economic conditions which influenced the music of America. Concert attendance required. Pass/No Pass/Letter Grade Option. (UC/CSU, AA GE, CSU GE, IGETC)

MUS 118 C Introduction to Opera**3 Units**

Term hours: 54 lecture. This course is an introduction to the standard operatic repertoire in terms of development of musical style, dramatic structure, and performance tradition. Emphasis is on elements of the art of operatic singing, voice classification, vocal range and technique, and dramatic values. Opportunities for attendance at operatic performances will be provided. Cost of music concert will not exceed \$30.00. Duplicate credit not granted for MUS 118HC. Pass/No Pass/Letter Grade Option. (UC Credit Limitation/CSU, AA GE, CSU GE, IGETC)

MUS 118HC Honors Introduction to Opera**3 Units**

Term hours: 54 lecture. This course offers an Introduction to Opera course enhanced for honors students in a seminar type setting. Students will survey the standard operatic repertoire in terms of development of musical style, dramatic structure and performance tradition with emphasis on the appreciation of the art of operatic singing, voice classification, vocal technique and dramatic values. Opportunities for field trips and seminars with performers and directors are included. Cost of music concert will not exceed \$30.00. Duplicate credit not granted for MUS 118 C. (UC Credit Limitation/CSU, AA GE, CSU GE, IGETC)

MUS 119 C History of Rock Music**3 Units**

Term hours: 54 lecture. From its earliest beginnings to the present day, this course surveys the inception, evolution, and development of Rock music in America and abroad. In addition to in-depth studies of Rock music and the artists who created it, students will examine the sociological, political, and economic conditions which influence its development. (UC/CSU, AA GE, CSU GE, IGETC)

MUS 120 C Survey of Music History**3 Units**

Term hours: 54 lecture. This course is designed for music majors or non-majors with some musical background. Students will study Western stylistical trends, major forms and theory from antiquity to the present. Recordings, video tapes, and live musical performances are used to emphasize material covered in class discussions. (UC/CSU, AA GE, CSU GE, IGETC)

MUS 124 C Recording Studio I**3 Units**

Advisory: MUS 108 C.

Term hours: 36 lecture and 54 laboratory. This class covers the fundamental concepts in audio recording technology. Topics include studio business practices, microphones, mixers, signal processors, the sound field, monitors, recording and editing devices, and synchronization. (CSU)

MUS 127 C Music in Film**3 Units**

Term hours: 54 lecture. The class traces the history and development of film music through reading, lecture and film viewing. The class studies the process of film scoring and how music and its relationship to film have changed over the last century. Class includes discussion and evaluation of different compositional styles and learning to listen critically to film scores while viewing movies. (UC/CSU, AA GE, CSU GE)

MUS 131 C Electric Bass**1 Unit**

Term hours: 18 lecture and 18 laboratory. This course uses group instruction to teach general techniques for the electric bass guitar. Blues, R&B, rock, pop and jazz styles are emphasized. (UC/CSU)

MUS 143 C Beginning Strings**1 Unit**

Term hours: 18 lecture and 18 laboratory. This course teaches the fundamentals of string playing for anyone interested in learning to play the violin, viola, violoncello, or string bass. Students must supply their own instruments. Open to all students, no previous experience necessary. (UC/CSU)

MUS 146 C Woodwind Class**1 Unit**

Term hours: 18 lecture and 18 laboratory. This is a course for students who wish to play flute, oboe, clarinet, bassoon, or saxophone. Students must supply their own instruments. Open to all students, no previous experience necessary. (UC/CSU)

MUS 152 C Percussion Class**1 Unit**

Term hours: 18 lecture and 18 laboratory. This is a course for students who wish to play drums, timpani, mallet instruments, and other percussion instruments. The class will emphasize basic music reading and rhythmical accuracy. Open to all students, no previous experience necessary. Pass/No Pass/Letter Grade Option. (UC/CSU)

MUS 156 C Jazz Improvisation - Instrumental**1 Unit**

Prerequisite: Audition to evaluate and assess the student's qualifications (proficiency) is required for enrollment.

Term hours: 18 lecture and 36 laboratory. This class provides intermediate level instrumental students with the tools and techniques for jazz improvisation. Analysis of harmonic and melodic materials, extensive listening, and performance exercises will assist the student in his/her development as an improviser. (UC/CSU)

MUS 157 C Jazz Improvisation - Vocal**1 Unit**

Term hours: 18 lecture and 36 laboratory. This course offers vocal students training in jazz song-styling techniques focusing on swing, ballad, Latin, blues, and contemporary styles. Topics include rhythmic and melodic improvisation, microphone technique, and scat singing. (UC/CSU)

MUS 175 C Swing Band**1 Unit**

Prerequisite: Audition.

Term hours: 54 rehearsal and 20-23 hours of sectional rehearsals, recording, program production and/or concerts. Students in this class will be involved in the rehearsal and concert performance of swing music in the style of the "Big Band Era" from the 1930's to 1950's. May be taken for credit 4 times. (UC/CSU, C-ID: MUS 180)

MUS 176 C Popular Songwriting**3 Units**

Advisory: MUS 101 C or MUS 103AC.

Advisory: Concurrent enrollment in MUS 238 C.

Term hours: 54 lecture. This is an introductory to intermediate course in popular songwriting. Students will learn keyboard skills and notation. They will analyze melody, harmony, song form, rhythm, and lyrics as they apply to popular music. Emphasis will be placed on original compositions and composition by well-known songwriters and recording artists. (CSU)

MUS 177 C Songwriting Workshop 3 Units

Term hours: 54 lecture. This is an intermediate to advanced workshop in popular songwriting. Students will analyze melody, harmony, song form, rhythm, and lyrics as they apply to popular songs. Emphasis will be placed on original compositions, while studying compositions by well-known songwriters and recording artists. (CSU)

MUS 178 C Digital Music Technology 3 Units

Term hours: 54 lecture and 36 laboratory. A comprehensive study of how digital technology is used in the music industry today. Designed for students with interest in songwriting, recording, audio production, and/or multimedia. Students will get hands-on experience with MIDI, keyboard synthesizers, sound modules, sequencers, sound editors, notation software, audio file formats (.wav, .mp3, .mid, etc.), and mastering to compact disc. (CSU)

MUS 203 C Theory III 3 Units

Formerly MUS 203AC

Prerequisite: MUS 105 C with a minimum grade of "C".

Corequisite: MUS 204 C.

Advisory: MUSA 231 C.

Term hours: 48-54 lecture. This course incorporates the concepts from Music Theory II. In addition, through writing and analysis, the course will include: introduction to chromatic harmony; secondary/applied chords; modulation; borrowed chords; introduction to Neapolitan and augmented-sixth chords. (UC/CSU, C-ID: MUS 140)

MUS 204 C Musicianship III 1 Unit

Prerequisite: MUS 106 C with a minimum grade of "C".

Corequisite: MUS 203 C.

Advisory: MUSA 231 C.

Term hours: 18 lecture and 18 laboratory. This course applies and develops the rhythmic, melodic, and harmonic materials of Music Theory III through ear training, sight singing, analysis, and dictation. (UC/CSU, C-ID: MUS 145)

MUS 205 C Theory IV 3 Units

Formerly MUS 203BC

Prerequisite: MUS 203 C with a minimum grade of "C".

Corequisite: MUS 206 C.

Advisory: MUSA 232 C with a minimum grade of "C" or piano proficiency audition.

Term hours: 54 lecture. This course incorporates the concepts from Music Theory III. In addition, through writing and analysis, the course will include: post-Romantic techniques such as borrowed chords and modal mixture, chromatic mediants, Neapolitan and augmented-sixth chords, 9th, 11th, and 13th chords, altered chords and dominants; and 20th century techniques such as: Impressionism, tone rows, set theory, pandiatonicism and polytonalism, meter and rhythm. (UC/CSU, C-ID: MUS 150)

MUS 206 C Musicianship IV 1 Unit

Prerequisite: MUS 204 C with a minimum grade of "C".

Corequisite: MUS 205 C.

Advisory: MUSA 232 C with a minimum grade of "C" or piano proficiency audition.

Term hours: 18 lecture and 18 laboratory. This course applies and develops the rhythmic, melodic, and harmonic materials of Music Theory IV through ear training, sight singing, analysis, and dictation. (UC/CSU, C-ID: MUS 155)

MUS 212 C Music Promotion and Distribution 3 Units

Term hours: 54 lecture. Music entrepreneurs will learn business procedures to form their own company, emphasizing strategies for the sale and promotion of music. The course covers topics such as the music marketing environment, hands-on marketing techniques, online sales and promotion, and the effects of technology in music publishing. (CSU)

MUS 222 C Audio Production for Film I 3 Units

Prerequisite: Mastery.

Term hours: 36 lecture and 72 laboratory. This course explores audio recording, editing and mixing using digital audio workstations. Topics include an introduction to the process of film production, field recording, sound effects and sound design, and synchronizing audio to video. (CSU)

MUS 223 C Audio Production for Film II 3 Units

Prerequisite: Mastery, MUS 108 C and MUS 222 C.

Term hours: 36 lecture and 72 laboratory. This course explores audio recording, editing and mixing using digital audio workstations. Topics include ADR, Foley, music editing, and final delivery. (CSU)

MUS 225 C Applied Music 1 Unit

Prerequisite: Audition and concurrent enrollment in a performing ensemble.

Term hours: 27 (Private instruction included). For the student seeking individual instruction on piano, voice, guitar, or any standard band or orchestra instrument. A performance at Faculty Juries is required each semester. Vocal and instrumental students should concurrently enroll in a choir or band class, pianists and guitarists should consult with faculty for an appropriate concurrent course. May be taken for credit 4 times. (UC/CSU, C-ID: MUS 160)

MUS 229 C Vocal Repertoire 1 Unit

Prerequisite: Audition.

Term hours: 18 lecture and 18 laboratory. This class provides a workshop environment for the study of vocal repertoire at the intermediate-to-advanced level. Repertoire will be drawn from traditional styles such as art songs, lieder, arias, and oratorios, as well as jazz, musical theater, and contemporary music. Students will focus on the development of their lyric diction and performance skills while being exposed to a wide variety of vocal literature. (CSU)

MUS 235 C Commercial Guitar and Bass 1 Unit

Prerequisite: Audition.

Term hours: 18 lecture and 18 laboratory. This course emphasizes blues, jazz, and rock techniques for intermediate-to-advanced guitarists and bassists. Topics include scales in all positions, chords, arpeggios, accompaniment styles, reading chord charts and sheet music, and practical theory. Students will obtain vocational "real world" experience to prepare them for careers as a professional guitarist and/or bassist. (UC/CSU)

MUS 238 C Popular Piano 1 Unit

Prerequisite: MUSA 131 C or by audition.

Term hours: 18 lecture and 18 laboratory. This course deals with the study of basic chords to allow keyboard freedom in improvising and song arranging with the use of melody and accompaniment to develop a creative style of playing, essential in popular music. It is designed for non-music majors as well as music majors. (UC/CSU)

MUS 260 C Classical Guitar Ensemble 1 Unit

Prerequisite: Audition.

Term hours: 18 lecture and 18 laboratory. The Cypress Classical Guitar Ensemble is dedicated to the rehearsal and performance of standard and contemporary duets, trios, quartets, and large ensemble pieces for the classical guitar. The ensemble participates in a department recital each semester. May be taken for credit 4 times. (UC/CSU)

MUS 261 C String Ensemble 1 Unit

Prerequisite: Audition.

Term hours: 18 lecture and 18 laboratory. The Cypress String Ensemble is dedicated to the rehearsal and performance of standard and contemporary duets, trios, quartets, and large ensemble pieces for the violin, viola, cello and contrabass. The ensemble participates in a department recital each semester. May be taken for credit 4 times. (UC/CSU)

MUS 273 C Concert Band**1 Unit***Prerequisite: Audition.*

Term hours: 54 hours rehearsal in sectional rehearsals, recording, program production and/or concerts. The student will be involved in the rehearsal and performance of standard wind and band literature. Performances required in the course of the semester may include concerts and tours. May be taken for credit 4 times. (UC/CSU, C-ID: MUS 180)

MUS 274 C Cypress Symphonic Winds**1 Unit***Prerequisite: Audition.*

Term hours: 18 lecture and 36 hours in sectional rehearsals, recording, program production and/or concerts. The Cypress Symphonic Wind Ensemble is dedicated to the rehearsal and performance of standard and contemporary literature for woodwinds, brass, and percussion. Performances required in the course of the semester may include concerts and tours. May be taken for credit 4 times. (UC/CSU, AA GE, C-ID: MUS 180)

MUS 276 C Jazz Band**1 Unit***Prerequisite: Audition.*

Term hours: 54 hours rehearsal in sectional rehearsals, recording, program production and/or concerts. This course studies the rehearsal and performance of jazz band literature. Sight reading is emphasized as a musical concept. The band performs in concert each semester, and student compositions and arrangements are encouraged. May be taken for credit 4 times. (UC/CSU, C-ID: MUS 180)

MUS 280 C Jazz/Musical Theater Choir**1 Unit***Prerequisite: Audition.*

Term hours: 54 hours in sectional rehearsals, recording, program production and/or concerts. This course is a vocal ensemble for beginning to advanced singers that focuses on repertoire from jazz, musical theater and popular styles. The ensemble will perform in concerts and may also participate in music festivals appropriate to this type of vocal group. Open to both music majors and non-majors. May be taken for credit 4 times. (UC/CSU, AA GE, C-ID: MUS 180)

MUS 281 C Concert Choir**1 Unit***Prerequisite: Audition.*

Term hours: 54 hours in sectional rehearsals, recording, program production and/or concerts. The Concert Choir performs an extensive repertoire ranging from Renaissance, Classical, and Baroque selections to contemporary Spirituals, Jazz, and Musical Theater. The choir presents four major concerts each season and participates in regional choral festivals. Open to all singers from the college and neighboring communities. Prospective singers should call for an audition appointment. May be taken for credit 4 times. (UC/CSU)

MUS 282 C Cypress Masterworks Chorale**1 Unit***Prerequisite: Audition.*

Term hours: 54 hours in sectional rehearsals, recording, program production and/or concerts. The Masterworks Chorale (80-110 singers) presents four major concerts each year with emphasis on masterworks for choir and orchestra. The Chorale participates in regional music festivals, performs at numerous locations throughout the Los Angeles basin, and tours internationally. Open to students and members of the community with prior singing experience. May be taken for credit 4 times. (UC/CSU, AA GE, C-ID: MUS 180)

MUS 283 C Cypress Singers**1 Unit***Prerequisite: Audition.*

Term hours: 54 hours in sectional rehearsals, recording, program production and/or concerts. The Cypress Singers is a group of 18 sopranos and altos which rehearse and perform a variety of repertoire ranging from Renaissance madrigals to contemporary music. The Singers perform in concerts and festivals each year as scheduling permits. Open to both music majors and non-majors by audition. May be taken for credit 4 times. (UC/CSU, C-ID: MUS 180)

MUS 285 C Chamber Singers**1 Unit***Prerequisite: Audition.*

Term hours: 54 hours in sectional rehearsals, recording, program production and/or concerts. The Chamber Singers is a select group of 24 mixed voices performing a variety of classical repertoire ranging from Renaissance madrigals to contemporary literature. The ensemble performs four major concerts per year, participates in regional music festivals, and performs at numerous locations throughout the Los Angeles basin. Open to both students and members of the community with extensive singing experience. May be taken for credit 4 times. (UC/CSU, C-ID: MUS 180)

MUS 287 C Vocal Jazz Ensemble**1 Unit***Prerequisite: Audition.*

Term hours: 18 lecture and 36 hours in sectional rehearsals, recording, program production and/or concerts. This course focuses on the rehearsal and performance of traditional and contemporary vocal jazz repertoire accompanied by a small instrumental ensemble. Some emphasis will be placed upon vocal improvisation in the jazz style. The ensemble will perform in concerts and may also participate in jazz and choral music festivals. Student compositions and arrangements are encouraged. May be taken for credit 4 times. (UC/CSU, C-ID: MUS 180)

MUS 295 C Music Internship**1 to 4 Units**

Term hours: This course is designed to give the student credit for work experience at a related occupational worksite, while being concurrently enrolled in a vocational major. For each unit of credit, a minimum of 75 paid or 60 unpaid worksite internship hours is required. The internship allows students to apply knowledge gained in college courses to an actual work setting, sample career choices and improve job-readiness skills. Supplemental reading and course assignments required. May be taken for credit 4 times. Pass/No Pass/Letter Grade Option. (CSU)

MUS 298 C Music Seminar**.5 to 12 Units***Prerequisite: May be required.**Corequisite: May be required.**Advisory: May be required.*

Term hours: 0-216 lecture and/or 0-936 laboratory depending on units attempted. Various classes may be offered which are designed to meet the interests and needs of students. Fees may be required—Payable at Registration. May be taken for credit 1-4 times. Pass/No Pass or Pass/No Pass/Letter Grade Option or Standard Letter Grade. (UC Credit Limitation/CSU)

MUS 299 C Music - Independent Study**1 to 2 Units***Prerequisite: Approved Independent Study Learning Contract.*

Term hours: 16-36 lecture. This course is designed for students who wish to increase their knowledge and experience in performance or applied areas. Unit credit may range from 1 to 2 units in any given semester. Consult the class schedule to verify credit for a particular term. May be taken for credit 4 times. (UC Credit Limitation/CSU)

Music — Applied (MUSA)**MUSA 104 C Introduction to Concert Hour****1 Unit**

Formerly MUS 122 C

Term hours: 18 lecture. This course is designed for the first semester music major. Providing the student with opportunities to expand their knowledge of music performance and specific composers and musical genres. Students will learn from guest artists and guest speakers. Selected students will be given the opportunity to perform during the term. Outside class activities include attendance at Cypress College Music Department concerts and the preparation of concert reports. This course is required of all music majors but open to all students. (CSU, AA GE)

MUSA 105 C Beginning Concert Hour 1 Unit*Prerequisite: MUSA 104 C with a minimum grade of "C".*

Term hours: 18 lecture. This course is required of all Music majors for four semesters and expands the student's knowledge of composers, genres and styles of music. This course is designed for the second semester music major. Providing the student with opportunities to expand their knowledge of music performance and specific composers and musical genres, and learn from guest artists and guest speakers. Selected students will be given the opportunity to perform during the term. Outside class activities include attendance at Music Department concerts and the preparation of concert reports. (CSU)

MUSA 106 C Intermediate Concert Hour 1 Unit*Prerequisite: MUSA 105 C.*

Term hours: 18 lecture. This course is designed for the third semester music major. Providing the student with opportunities to expand their knowledge of music performance and specific composers and musical genres, and learn from guest artists and guest speakers. Selected students will be given the opportunity to perform during the term. Outside class activities include attendance at Music Department concerts and the preparation of concert reports. (CSU)

MUSA 107 C Advanced Concert Hour 1 Unit*Prerequisite: MUSA 106 C.*

Term hours: 18 lecture. This course is designed for the fourth semester music major, providing the student with opportunities to expand their knowledge of music performance and specific composers and musical genres, and learn from guest artists and guest speakers. Selected students will be given the opportunity to perform during the term. Outside class activities include attendance at Cypress College concerts and the preparation of concert reports. (CSU)

MUSA 111 C Beginning Voice 1 Unit

Formerly MUS 126 C

Term hours: 18 lecture and 18 laboratory. This course is an entry level class for inexperienced singers who wish to explore the Voice Major. Providing a study of basic vocal techniques, the course explores tone production, breath control, pronunciation, and choice of song literature. Required out of class activities include one hour practice in Practice Room per week and participation in recitals. (UC/CSU)

MUSA 112 C Intermediate Voice I 1 Unit*Prerequisite: MUSA 111 C or Audition.*

Term hours: 18 lecture and 18 laboratory. This course, which provides a study of vocal literature and techniques in a class situation, emphasizes individual progress in tone production, breath control and diction. Repertoire is primarily 18th and 19th century Italian songs and arias. The course is designed for the voice major not yet qualified for the Advanced Voice classes and for promising non-majors. Out of class activities include one hour of practice per week in Practice Room Suite and preparation for recitals. (UC/CSU)

MUSA 120 C Beginning Guitar 1 Unit

Formerly MUS 130 C

Term hours: 18 lecture and 18 laboratory. This course focuses on the fundamentals of playing the guitar: technique, note reading, scales, chords, simple picking and strumming patterns. The repertoire includes a wide variety of musical styles, from classical to rock. (UC/CSU)

MUSA 121 C Intermediate Guitar 1 Unit

Formerly MUS 231 C

Prerequisite: MUSA 120 C or audition.

Term hours: 18 lecture and 18 laboratory. Designed for more advanced non-guitar major or the guitar major who is not yet qualified for Classical or Jazz Guitar, this course continues the study of guitar study from MUSA 120 C with emphasis on more advanced literature and techniques. Emphasis is placed on individual progress in execution and interpretation. (UC/CSU)

MUSA 130 C Introduction to Piano for Non-Majors 1 Unit

Term hours: 18 lecture and 18 laboratory. This course is designed for non-music majors whose piano skills are non-existent or very limited. This course provides an introduction to the fundamentals of piano playing: posture, keyboard topography, note reading, 5-finger-pattern exercises, sight-reading, and piano repertoires. This course is open to all students. Pass/No Pass/Letter Grade Option. (UC/CSU)

MUSA 131 C Keyboard Skills I 1 Unit*Prerequisite: Audition.**Advisory: Students should be able to demonstrate appropriate piano proficiency for this course.*

Term hours: 18 lecture and 18 laboratory. This course is designed for music majors preparing for a university keyboard proficiency exam, this course is the entry-level keyboard musicianship class with emphasis on basic keyboard harmonization, hand independence, transposition, sight-reading, rhythm accuracy and elementary piano repertoires. (UC/CSU)

MUSA 132 C Keyboard Skills II 1 Unit*Prerequisite: MUSA 131 C with a minimum grade of "C" or successful audition.*

Term hours: 18 lecture and 18 laboratory. This course is a continuation of MUSA 131 C for music majors. It includes emphasis on basic keyboard harmonization using primary chord inversions, technique, transposition, accompaniment patterns, rhythm accuracy and late elementary/early intermediate piano repertoires. Pass/No Pass/Letter Grade Option. (UC/CSU)

MUSA 210 C Advanced Voice 1 Unit*Prerequisite: Completion of or concurrent enrollment in MUSA 112 C with a minimum grade of "C" or by audition.*

Term hours: 18 lecture and 18 laboratory. This course offers individual instruction in vocal techniques and interpretation of solo voice literature in a class situation. Emphasis is placed on repertoire and public performance. Participation in recitals plus one hour practice in Practice Room per week is required. Designed for music majors but open to all students. Pass/No Pass/Letter Grade Option. (UC/CSU)

MUSA 221 C Classical Guitar 1 Unit

Formerly MUS 232 C

Prerequisite: MUSA 121 C or audition.

Term hours: 18 lecture and 18 laboratory. Designed for music majors, this advanced class provides intensive individual instruction in guitar techniques and interpretation of solo guitar literature. The course places emphasis on building repertoire and performing music from the Classical Music to Contemporary periods. (UC/CSU)

MUSA 231 C Keyboard Skills III 1 Unit

Formerly MUS 236 C

Prerequisite: MUSA 132 C with a grade of "C" or better or audition.

Term hours: 18 lecture and 18 laboratory. This course follows MUSA 132 C in keyboard musicianship sequence. Individualized instruction will focus on keyboard harmony using primary and secondary chords, introduction to basic score reading, transposing to concert pitch, rhythm, and early intermediate/intermediate piano repertoires including classical, blues, national and folk tunes. (UC/CSU)

MUSA 232 C Keyboard Skills IV**1 Unit***Prerequisite: MUSA 231 C with a minimum grade of "C" or by audition.*

Term hours: 18 lecture and 18 laboratory. This course is an advanced level in keyboard musicianship sequence. Rigorous individualized instruction will focus on keyboard harmony using secondary dominant chords, 3-voice choral score reading, specialized rhythm, intermediate to late intermediate standard repertoires, memorization, and self-critiquing skills. Pass/No Pass/Letter Grade Option. (UC/CSU)

Nursing Program

Registered

Division of Health Science

Division Dean — Rebecca Gomez, Interim*Director of Nursing* — Darlene Fishman

Faculty

Michael Faraci

Darlene Fishman

Sally Frumkin

Carol Harvey

Shinah Kim

Kathleen Kruse

Denise Medina-Bernstein

Sally McNay

Ryan Ortega

Elizabeth Putman

Susie Smith

Judy Swytak

Wendy Valencia

Jane Walker

Marredda Williams

Counselors

Kelly Carter

Denise Vo

Doreen Villaseñor

PROGRAM LEARNING OUTCOMES (PLOs)

Nursing

The graduate of the Cypress College Nursing Program will be competent when he/she consistently provides safe, quality, patient centered care. The graduate uses sound nursing judgment and best practices to meet patient care needs for oxygenation, regulation and movement across the lifespan. The graduate nurse demonstrates advocacy for patients/families in a coordinated manner using open interprofessional communication while maintaining mutual respect and shared decision-making to achieve safe quality patient outcomes. The graduate uses evidence to make decisions and promotes quality improvement. The professional nurse uses information and technology to support decision-making and effective communication while demonstrating professionalism.

Graduate Outcomes (*Competencies*):

1. Employ practices to ensure safety of patients and improve outcomes of care. (*Safety*)
2. Advocate for patients, recognizing the patient or designee as the source of control and as full partner in providing compassionate and coordinated care based on respect for patient's preferences, values, and needs. (*Patient Centered Care*)
3. Collaborate effectively within nursing and inter-professional teams, fostering open communication, mutual respect, and shared decision-making to achieve safe, quality patient care in a variety of health care settings. (*Teamwork and Collaboration*)
4. Use nursing judgment based on best current evidence to provide safe care for patients and families across the lifespan. (*Evidence-Based Practice*)
5. Apply principles of quality improvement to monitor the outcomes of care and minimize risk of harm to patients and providers. (*Quality Improvement*)
6. Use information and technology to communicate, document care, minimize error, and support decision making. (*Informatics*)
7. Utilize best practices and sound nursing judgment to address oxygenation issues, maintain regulation, and guide movement in patients across the lifespan. (*Oxygenation, Regulation, Movement*)
8. Demonstrate professionalism in the implementation of the role of the registered nurse. (*Professionalism*)

Accredited by: (ACEN formerly NLNAC)

Accreditation Commission for Education in Nursing, Inc.

3343 Peachtree NE, Suite 500

Atlanta, GA 30326

(404) 975-5000

Fax (404) 975-5020

MISSION STATEMENT

The Registered Nursing Program provides student centered education designed to prepare graduates to practice as registered nurses and provides a foundation for lifelong learning. Cypress College registered nurse graduates provide safe, quality, patient centered care.

PHILOSOPHY STATEMENT

The Cypress College nursing faculty ascribes to the core competencies for nursing and nursing education identified by the Quality and Safety Education for Nurses (QSEN) project. While firmly based in science and the arts, the essence of nursing is caring and compassionate patient centered care. Ethical standards, respect for individual dignity, and consideration of cultural context are implicit in the practice of patient-centered care. The nurse advocates for patients and families in ways that promote self-determination, integrity, and ongoing growth as human beings. Nursing care is provided in collaboration with the patient, the family and members of the health care team. The nurse displays a spirit of inquiry by examining evidence to improve quality of care, promote safety and improve patient outcomes. Nursing judgment is integral to making competent decisions related to the provision of safe and effective nursing care. In order to make informed clinical decisions, the nurse must have a firm foundation in and understanding of the concepts of oxygenation, regulation and movement. Information essential to nursing care is communicated via a variety of technological and human means. The adoption of these key philosophical components fosters the development of the nurse's professional identity.

TEACHING/LEARNING

The nursing faculty believes that learning is a dynamic process which results in behavioral changes. Learning occurs throughout the life cycle and can aid in maximization of any individual's potentials. The individual student's potentials are developed through use of the nursing process, a professional proactive approach to problem-solving. The curriculum provides opportunities for facilitating learning based on individual styles of learning. Self-motivation and active participation in the classroom and clinical laboratory are necessary components of the learning process for adult learners.

The curriculum is organized from simple to complex concepts which are as identified in each course outline. Multiple methods of instruction are utilized to address the content being studied, to enhance learning, and to provide for individual differences in both teaching and learning styles. The structure and content of each course is designed to support the department's philosophy of nursing education. The student is recognized as an individual who moves toward goals of self-realization and fulfillment.

ROLE OF THE TEACHER AND STUDENT

The role of the teacher is to identify the learning needs of the student and to facilitate the student's optimal level of learning achievement. A systematic approach is utilized to assist the student in assessment of learning needs, development of learning goals, selection and implementation of learning methods and strategies, and evaluation of outcomes. Differences in individual needs, learning styles, ethnicity and cultural background are essential considerations in effective teacher-student relationships.

NURSING AND PERSONAL RESPONSIBILITY FOR HEALTH PROMOTION PRACTICES

The Cypress College nursing faculty recognizes the value of high-level wellness and supports the concept of the nurse being a positive role model for health practices. The entering student needs to be aware of his/her health-promoting behaviors in the area of general health (i.e., rest and sleep, nutrition, therapeutic recreation). The student should also be aware of and avoid behaviors detrimental to health.

SPECIAL REQUIREMENTS, EQUIPMENT AND EXPENSES INCURRED BY NURSING STUDENTS UPON ENROLLMENT IN THE NURSING PROGRAM

This information is intended to assist those who are planning enrollment in the registered nursing program prepared for educational expenses. In addition to enrollment fees PAYABLE AT REGISTRATION, the nursing student incurs additional expenses. The nursing student should anticipate an expenditure of approximately \$6,000 over the two years of enrollment in nursing program courses.

Clinical practice sites are located throughout Orange and Los Angeles counties. Clinical rotations may be scheduled for both day and evening shifts in order to provide the best learning opportunities. The student will need reliable personal transportation in order to travel to assigned hospitals at least two days a week in each nursing course.

The nature of the learning experiences in the registered nursing program requires that students engage in direct patient care in assigned clinical facilities. All enrolled students are required to meet the same health and safety standards required of nurses in the contracted clinical facilities. For this reason each student enrolled in the nursing program must complete the following requirements at his/her own expense prior to the first day of attendance:

1. **Physical examination with health clearance indicating good physical and mental health status with no limitations to providing direct patient care.**
2. Proof of current immunizations or immunity by titer.
3. Testing for communicable diseases including, but not limited to, the following: Tuberculosis, rubella, rubeola, varicella, hepatitis.
4. Malpractice insurance and health insurance.
5. Current CPR certification at the Professional Health Provider level.
6. Background checks.

In addition, the student will need to purchase required uniforms, watch with sweep second hand, name badge, stethoscope, and other equipment required for clinical practice.

Information regarding the specific requirements in place at the time of initial enrollment into nursing clinical courses is provided at a mandatory orientation meeting scheduled for applicants selected each semester.

ASSOCIATE IN SCIENCE DEGREE PROGRAM REGISTERED NURSING Program Code: 1S03785

The program educates nursing students for patient/client services in a variety of health care settings. Clinical experience in hospitals and other health care agencies is correlated with classroom instruction. At the satisfactory completion of all courses and the specified general education requirements, the individual will receive an Associate in Science degree and will be eligible to write the Registered Nursing State Licensing Examination. **(If you have been convicted of any offense other than a minor traffic violation, it may prevent your attending clinical rotations where criminal background checks are required. You will be required to declare offenses on your state application to write the licensing exam, which may affect your eligibility to become licensed.)**

The nursing program is approved by California State Board of Registered Nursing and nationally accredited by the NCNAC. For the requirements to complete the Associate in Science Degree, see the Graduation Requirements for the Associate Degree section of this catalog.

MINIMUM STANDARDS FOR APPLICANTS

1. Eligibility for admission to Cypress College.
2. High school graduation, or passing of the General Education Development Test (GED), or the High School Proficiency Test, or a graduate of an accredited college.
3. Good physical and mental health as determined by a medical examination upon admission to the program. In compliance with the *State Board of Registered Nursing Guidelines*, no student with impaired health status (which includes use of legal or illegal drugs, alcohol, or other chemicals) shall be admitted or allowed to remain enrolled in the Nursing Program. Students applying to the Nursing Program with a history of substance abuse, physical impairment, or mental/emotional impairment shall be required to provide proof of active participation in a recognized treatment program at the time of application. Evidence of continuing rehabilitation may be required if admitted or re-admitted to the Nursing Program. These standards are necessary for the Cypress College Registered Nursing Program to be in compliance with the *Board of Registered Nursing Guidelines* and maintain full accreditation.
4. Total college grade point average (GPA) of 2.0 ("C") or better.
5. Completion of ENGL 100 C with "C" or better as determined by a counselor from transcript.
6. Completion of BIOL 231 C (General Anatomy), BIOL 241 C (Human Physiology), (CHEM 101 C strongly recommended), and BIOL 220 C (Medical Microbiology) with "C" or better. All must have been completed within five years of application.

APPLICATION PROCEDURES

See application on Health Science application website.

Applications must be completed **online** September 1–10. Please see the **Health Science Application link** on the Registered Nursing home page.

Applicants must submit official transcripts (except Cypress and Fullerton Colleges) and signature page **in person** to the Health Science Applications office, Health Science Building, Cypress College 9200 Valley View Street, Cypress, California 90630-5897 by **October 1st**. Please bring photo identification.

The Nursing Program admits students twice each year, fall and spring. Applicants will be notified of status via email.

All applicants who wish to remain on the applicant list must file an updated application every year during the application period in September. Applicants again will be notified of updated status in writing.

Notify the Health Science Application Office in Writing:

1. if you change your name, address or telephone number
2. if you wish to withdraw your name as an applicant

Please Note: F-1 visa students will not be accepted for admission into any program when applications by qualified U.S. citizens exceed space available.

Contact Health Science Application Office for the specific final days of application, hours and last day to submit transcripts because of holidays or weekends, (714) 484-7270.

REGISTERED NURSING CURRICULUM

Program Code: 1S03785

Nursing courses must be taken in specific sequence. For further information, see a Health Science Counselor. The student must attain a minimum grade of "C" in each required course to continue in the program.

All students will have to meet the prerequisites of English 100, Anatomy, Physiology, and Microbiology. The nursing program also requires completion of Introduction to Psychology, Introduction to Sociology, and Human Communication.

Per SB 139, section 66055.8 of the Education Code, California Community Colleges that operate a registered nursing program shall waive the general education requirements for the associate of science degree, in Nursing, for any student who has been admitted to the program and who has already earned a baccalaureate or higher degree. Cypress College will only accept degrees granted from a regionally accredited institution of higher education.

Required Courses are listed in required sequence:

| Course # | Title | Units |
|-----------------------|---|-------------|
| PREREQUISITES | | |
| ###BIOL 231 C | General Human Anatomy | 4 |
| ###BIOL 241 C | General Human Physiology | 4 |
| ###BIOL 220 C | Medical Microbiology | 4 |
| *ENGL 100 C | College Writing | 4 |
| | | 16 |
| SEMESTER I | | |
| NURS 191 C | Pharmacology in Nursing I | 1 |
| **#PSY 101 C | Introduction to Psychology | 3 |
| NURS 192 C | Fundamentals of Nursing | 4.5 |
| NURS 193 C | Introduction to Medical-Surgical/ Gero Nursing | 3.5 |
| | | 12 |
| SEMESTER II | | |
| NURS 195 C | Pharmacology in Nursing II | 1 |
| #SOC 101 C | Introduction to Sociology | 3 |
| | Physical Education Requirement | 1 |
| NURS 196 C | Medical-Surgical Nursing I | 5 |
| NURS 197 C | Maternal/Newborn Nursing | 3.5 |
| | | 13.5 |
| SUMMER SESSION | | |
| | *Art (Category C1) Requirement | 3 |
| SEMESTER III | | |
| #COMM 100 C | Human Communication | 3 |
| NURS 291 C | Pharmacology in Nursing III | 1 |
| NURS 292 C | Medical-Surgical Nursing II | 5 |
| NURS 293 C | Mental Health Nursing | 3.5 |
| NURS 294 C | Geriatric Nursing | 3 |
| | | 15.5 |

| SEMESTER IV | | |
|--------------------|----------------------------------|--------------|
| NURS 295 C | Pharmacology in Nursing IV | .5 |
| ***#MATH 040 C | Intermediate Algebra (or higher) | 4–6 |
| NURS 296 C | Child/Family Nursing | 3.5 |
| NURS 297 C | Medical-Surgical Nursing III | 5 |
| | *Humanities (Category C2) | 3–5 |
| | | 16–20 |

*A score of 3 or higher on the Advanced Placement (AP) English Lang. and Comp. or English Lit. and Comp. exam meets this requirement upon petition through Admissions and Records. See a counselor for more information.

**A score of 3 or higher on the Advanced Placement (AP) Psychology exam meets this requirement upon petition through Admissions and Records. See a counselor for more information.

***A score of 3 or higher on the Advanced Placement (AP) Math (Calculus AB) or Math (Calculus BC) exam meets this requirement upon petition through Admissions and Records. See a counselor for more information.

#May be taken prior to program for selection purposes, but **must be** completed at least by semester indicated.

##Proficiency Examination available — see Health Science Counselor.

###Must be taken within five years of application.

All nursing courses are challengeable. See Nursing Program Director.

Graduation requirements: Cultural Diversity (beginning Fall 2000 catalog, the nursing program meets the requirement) and Reading Proficiency. See Counselor/Catalog.

TRANSFER OF CREDIT

Transfer credit for nursing courses taken from another accredited institution may be granted provided the applicant meets the Cypress College Department of Nursing entrance requirements and space is available in the program. Contact the Health Science Application Office for written policy and procedure.

Credit will be granted on an individual basis after evaluation by the Department of Nursing. Transfer credit for equivalent general education courses required by the Department of Nursing will be granted if the course has been completed at an accredited college.

Any required course in the biological or Social Sciences listed below, completed over five years previous to the time the student applied to the program, must be repeated or the student may receive credit by challenge examination, or be evaluated on an individual basis.

| | |
|------------|--------------------------|
| BIOL 231 C | General Human Anatomy |
| BIOL 241 C | General Human Physiology |
| BIOL 220 C | Medical Microbiology |

CAREER MOBILITY: LICENSED VOCATIONAL NURSE TO REGISTERED NURSE Program Code: 1S00003

LICENSED PSYCHIATRIC TECHNICIAN TO REGISTERED NURSE Program Code: 1S00004

The nursing program provides an opportunity for Licensed Vocational Nurses and Licensed Psychiatric Technicians to complete the Registered Nursing curriculum. The individual completing the registered nursing program and general education requirements is eligible to take the Registered Nursing State Licensing Examination. As a graduate of the Cypress College Registered Nursing Program, the student will receive an Associate in Science degree.

MINIMUM STANDARDS FOR APPLICANTS

1. Eligibility for admission to Cypress College.
2. High school graduation or passing of the General Education Development (GED) test or the High School Proficiency Test or a graduate of an accredited college.
3. Good physical and mental health as determined by a medical examination upon admission to the program. In compliance with the *State Board of Registered Nursing Guidelines*, no student with impaired health status (which includes use of legal or illegal drugs, alcohol, or other chemicals) shall be admitted or allowed to remain enrolled in the Nursing Program. Students applying to the Nursing Program with a history of substance abuse, physical impairment, or mental/emotional impairment shall be required to provide proof of active participation in a recognized treatment program at the time of application. Evidence of continuing rehabilitation may be required if admitted or re-admitted to the Nursing Program. These standards are necessary for the Cypress College Registered Nursing Program to be in compliance with the Board of Registered Nursing Guidelines, and maintain full accreditation.
4. Verification of completion of a program or its equivalent preparing for a Licensed Vocational Nurse or Psychiatric Technician and 6 months experience at the time of application.
5. Successful completion of the Career Mobility Proficiency Exams. (See Health Science Counselor for specific information on testing criteria and procedures.)
6. Successful completion of the Career Mobility Clinical Skills Validation Performance Exam. (See Health Science Counselor for specific information on testing criteria and procedures.)
7. Total college grade point average (GPA) of 2.0 ("C") or better.

PREREQUISITES

Completion of the following courses with a grade of “C” or better:

| Course # | Title | Units |
|--------------|----------------------------|-------|
| ##BIOL 231 C | General Human Anatomy | 4 |
| ##BIOL 241 C | General Human Physiology | 4 |
| ##BIOL 220 C | Medical Microbiology | 4 |
| *ENGL 100 C | College Writing | 4 |
| +**PSY 101 C | Introduction to Psychology | 3 |
| #NURS 090 C | Nursing Transitions | 3.5 |

22.5

#This course, available in the summer only, includes a clinical rotation. It is required for career mobility students seeking advancement into the Registered Nursing Program. Applicants will be assigned a placement number on the qualified mobility placement list upon successful completion of this course with a grade of “C” or better.

##Must be taken within ten years of application.

+May be in progress at the time of application, but must be completed prior to acceptance in the Nursing Program.

*A score of 3 or higher on the Advanced Placement (AP) English Lang. and Comp. or English Lit. and Comp. exam meets this requirement upon petition through Admissions and Records. See a counselor for more information.

**A score of 3 or higher on the Advanced Placement (AP) Psychology exam meets this requirement upon petition through Admissions and Records. See a counselor for more information.

APPLICATION DEADLINES

FALL OR SPRING CLASSES

Applications are accepted after successful completion of career mobility proficiencies and skills validation testing. A counseling appointment is mandatory to review program and application procedure.

APPLICATION REQUIREMENTS

1. Must have completed all prerequisites.
2. Possess a current California LVN or PT license.
3. Must have completed application.
4. Satisfactory completion of NURS 090 C, with a grade of “C” or better.

CAREER MOBILITY: LVN/PT TO REGISTERED NURSING CURRICULUM

General Education requirements — the following courses must be completed prior to expected date of graduation with a grade of “C” or better.

| Course # | Title | Units |
|------------|----------------------------------|-----------|
| SOC 101 C | Introduction to Sociology | 3 |
| COMM 100 C | Human Communication | 3 |
| MATH 040 C | Intermediate Algebra (or higher) | 4 |
| | Art (C1 course) | 3 |
| | Humanities (C2 Course) | 3 |
| | Physical Education Requirement | 1 |
| | Total Units Required | 17 |
| | Reading Proficiency | |

NOTE: All Cypress College graduates must meet the following two requirements: Cultural Diversity (beginning with the Fall 2000 catalog, the nursing program meets the requirement) and Reading Proficiency. See counselor/catalog.

Nineteen and one half units may be awarded for holders of a valid California Vocational Nursing license. Credits are posted to transcripts upon completion of all other graduation requirements. Students must provide a copy of their current California license with their application to the Director of Nursing to be eligible for this credit.

Fourteen and one half units may be awarded for holders of a valid California Psychiatric Technician license. Credits are posted to transcripts upon completion of all other graduation requirements. Students must provide a copy of their current California license with their application to be eligible for this credit.

LICENSED VOCATIONAL NURSE TO REGISTERED NURSE Program Code: 1S00003

Required courses are listed in sequence:

| Course # | Title | Units |
|-----------------------------|------------------------------|-------------|
| SEMESTER I | | |
| NURS 292 C | Medical-Surgical Nursing II | 5 |
| NURS 293 C | Mental Health Nursing | 3.5 |
| NURS 294 C | Geriatric Nursing | 3 |
| SEMESTER II | | |
| NURS 295 C | Pharmacology in Nursing IV | .5 |
| NURS 296 C | Child/Family Nursing | 3.5 |
| NURS 297 C | Medical-Surgical Nursing III | 5 |
| Total Units Required | | 20.5 |

PSYCHIATRIC TECHNICIAN TO REGISTERED NURSE Program Code: 1S00004

| Course # | Title | Units |
|-----------------------------|------------------------------|-------------|
| SEMESTER I | | |
| NURS 196 C | Medical-Surgical Nursing I | 5 |
| NURS 197 C | Maternal/Newborn Nursing | 3.5 |
| SEMESTER II | | |
| NURS 292 C | Medical-Surgical Nursing II | 5 |
| NURS 294 C | Geriatric Nursing | 3 |
| SEMESTER III | | |
| NURS 295 C | Pharmacology in Nursing IV | .5 |
| NURS 296 C | Child/Family Nursing | 3.5 |
| NURS 297 C | Medical-Surgical Nursing III | 5 |
| Total Units Required | | 25.5 |

CAREER MOBILITY: LICENSED VOCATIONAL NURSE TO NON-DEGREE REGISTERED NURSE

A Licensed Vocational Nurse may apply for admission to the Registered Nursing Program to meet the requirements for licensure of the State Board of Registered Nursing in California. Thirty-Unit Option applicants shall have equal access to open space in the required nursing courses.

MINIMUM STANDARDS FOR APPLICANTS

1. Applicants must meet Cypress College entrance requirements.
2. Verification of completion of a program or its equivalent, preparing for a Licensed Vocational Nurse.
3. Satisfactory completion of BIOL 210 C, with Lab, 5 Units (or equivalent) with a grade of “C” or better.
4. Satisfactory completion of (or concurrent enrollment in) BIOL 220 C, (or equivalent) with a grade of “C” or better.

APPLICATION DEADLINES

Applications are accepted after successful completion of career mobility proficiency and skills validation. A counseling appointment is **mandatory** to review program and application procedure.

SELECTION PROCEDURE

Applications normally exceed capacity. Applicants should obtain specific information and counseling information sheets from the Health Science Counseling Office. It is the applicant’s responsibility to verify that documents, transcripts and records are on file.

29-UNIT NON-DEGREE OPTION CAREER MOBILITY: LICENSED VOCATIONAL NURSE TO NON-DEGREE REGISTERED NURSE

A Licensed Vocational Nurse may apply for admission to the Nursing Program to meet the requirements for licensure of the State Board of Registered Nursing in California. Thirty-Unit Option applicants shall have equal access to open space in the required nursing courses.

CURRICULUM

Courses **MUST** be taken in this specified sequence:

Natural Science Requirement — 9 Units

| Course # | Title | Units |
|------------|------------------------|-------|
| BIOL 210 C | Anatomy and Physiology | 5 |
| BIOL 220 C | Medical Microbiology | 4 |

Nursing Requirement — 20 Units

| | | |
|-----------------------------|------------------------------|-----------|
| NURS 090 C | Nursing Transitions | 3.5 |
| NURS 292 C | Medical-Surgical Nursing II | 5 |
| NURS 293 C | Mental Health Nursing | 3.5 |
| NURS 294 C | Geriatric Nursing | 3 |
| NURS 297 C | Medical-Surgical Nursing III | 5 |
| Total Units Required | | 29 |

ASSOCIATE IN SCIENCE DEGREE FOR REGISTERED NURSES FROM A DIPLOMA SCHOOL OF NURSING

This program is designed to enable a Registered Nurse from a diploma school of nursing to earn an Associate in Science Degree. Diploma Nursing School graduates with a current California license will receive 40 units of credit towards an Associate in Science Degree upon completion of general education and residency requirements at Cypress College. For the requirements to complete the Associate in Science Degree, see the Graduation Requirements for the Associate Degree section of this catalog. A petition is required for students requesting a waiver if 50% of their course work in the major was not completed at Cypress College. See your Health Science Counselor.

Nursing Four Year

TRANSFER PROGRAM

Students should consult a counselor or www.assist.org for lower division major requirements for most California public universities. (See the Standard Definitions section of the catalog for a description of ASSIST.) Students transferring to an independent college/university should consult the catalog of the individual school and a counselor for lower division major requirements.

Nursing (NURS)

NURS 090 C Nursing Transitions

3.5 Units

This course is designated for the experienced (no less than six months documented work experience in their licensed capacity) LVN/LPT who is preparing to enter the Registered Nursing career ladder program. The course will enhance theoretical and technical nursing skills in areas such as communication, ethics, fluid and electrolytes, and pharmacology. Students will develop in-depth skill in utilization of the nursing process. Major emphasis is placed on assessment of patient’s biopsychosocial needs and related interventions. This course promotes Quality & Safety Education for Nurses (QSEN) competencies that incorporate patient-centered care, safety teamwork, collaboration, evidence based practice, quality improvement and informatics. The course emphasizes specific knowledge and skills not included in LVN/PT curricula. \$19.00 Laboratory Fee-Payable at Registration.

NURS 091 C Strategies-Success in Nursing

.5 Units

Term hours: 9 lecture. This course is designed as a preparatory seminar for nursing students. The course will begin to develop the skills needed to succeed in a patient centered health care curriculum where students must be able to assimilate knowledge and apply it in a clinical practice setting. The course will provide students with behavioral and problem solving tools to develop personal and professional strategies for success in the health care field. Non Degree Credit. Pass/No Pass/Letter Grade Option.

NURS 099 C Nursing Independent Study

.5 to 2 Units

Prerequisite: Approved Independent Study Learning Contract.

Term hours: 9-36 depending on units attempted. This course is designed for capable students enrolled in the Registered Nursing program or options of the program who wish to increase their knowledge and experience in applied areas of patient centered care. Students will participate in independent study on assigned areas under staff supervision. Variable Unit Class. May be taken for credit 4 times. Pass/No Pass/Letter Grade Option.

NURS 103 C Basic Health Assessment

.5 Units

Prerequisite: NURS 192 C; Licensed Psychiatric Technician; Licensed Vocational Nurse; Registered Nurse.

Term hours: 9 lecture. This elective course provides specialized nursing knowledge in assessing basic health status in the non-pregnant adult. Students will recall and build upon the curricular concepts learned in preceding nursing courses of patient centered care, safety, oxygenation, regulation and movement using teamwork and collaboration, professionalism, evidence based practice, quality improvement and informatics, to apply the nursing process and utilize techniques for performing both history and physical assessments. Pass/No Pass/Letter Grade Option. (CSU)

NURS 104 C Introduction to ECG Interpretation

.5 Units

Prerequisite: NURS 191 C, NURS 193 C; Licensed Vocational Nurse; Registered Nurse or permission of instructor.

Term hours: 9 lecture. This elective course provides specialized nursing knowledge in providing patient centered care to patients experiencing oxygenation disorders; cardiac dysrhythmias, using teamwork and collaboration, professionalism, evidence based practice, quality improvement and informatics. Introductory course for nurses working with cardiac monitored patients. Cardiac dysrhythmias include sinus, atrial, AV heart blocks, junctional, and ventricular dysrhythmias. Initial patient monitoring, lead placement, techniques and equipment utilized to measure and identify cardiac arrhythmias are addressed in introductory terms. Basic therapies based on current ACLS standards and nursing implications for these dysrhythmias are discussed. Pass/No Pass/Letter Grade Option. (CSU)

NURS 107 C Pain Management for Nurses 1 Unit*Prerequisite: NURS 192 C with a minimum grade of "C".*

Term hours: 18 lecture. This course introduces the student to safe patient centered care for pain assessment and management strategies for use in daily clinical practice, based on the California Board of Registered Nursing's Pain Management Policy. Physiologic, psychologic, sociologic, and cultural aspects of pain are examined within the context of the nursing process. The student will learn to effectively prevent and control patient pain and improve patient outcomes by pharmacologic and non-pharmacologic means. Ethical issues and barriers to effective pain management are considered. Pass/No Pass/Letter Grade Option. (CSU)

NURS 108 C Orthopaedic Patient Care .5 Units*Advisory: NURS 192 C.*

Term hours: 9 lecture. This course is an overview of the general concepts of orthopaedic nursing including assessment of patients with movement disorders and orthopaedic injuries requiring safe patient centered nursing care. Designed to give the participant an introduction to the specialty of orthopaedic nursing, this course includes review of evidence based care of patients experiencing immobilization treatment, total joint arthroplasty, spinal surgery, amputation, as well as orthopaedic complications. The content of the course is based on orthopaedic nursing practice standards and patient teaching implications as developed by the National Association of Orthopaedic Nurses. Pass/No Pass/Letter Grade Option (CSU)

NURS 190 C Introduction to Nursing Concepts 2 Units

Term hours: 36 lecture. This course introduces the health science student to the theoretical basis of nursing and patient centered care. Emphasis is placed on psychosocial concepts inherent to the development of professionalism, teamwork and collaboration, evidence based practice, quality improvement and informatics. Professional nursing roles and interaction skills are applied to the health care setting. The effects of regulation of stress and developmental patterns on individual health care needs are introduced. Major social and cultural issues in relation to health care are discussed. Teaching/learning strategies unique to health care, nursing, and clinical instruction are explored. (CSU)

NURS 191 C Pharmacology in Nursing I 1 Unit*Prerequisite: Acceptance in the Nursing Program, LVN or PT.*

Term hours: 18 lecture. This pharmacology course correlates with the content in NURS 192 C and NURS 193 C. It introduces the concepts of patient centered care, teamwork and collaboration, professionalism, evidence based practice, quality improvement and informatics to safely administer both enteral and topical medications to patients in basic medical-surgical areas with oxygenation, regulation and movement disorders. (CSU)

NURS 192 C Fundamentals of Nursing 4.5 Units*Prerequisite: Acceptance in the Nursing Program.*

Term hours: 45 lecture and 108 laboratory. This course is an introduction to the nursing process and applying quality and safety standards within a spirit of inquiry firmly based in the science and art of nursing. This course will prepare the student to provide safe, patient-centered care within an environment of interdisciplinary teamwork and collaboration. The course is designed to provide the student with fundamental provider of care roles and critical thinking skills in order to develop and deliver a basic plan of care. Fundamental exemplars will be introduced with an emphasis on basic oxygenation, patient and nurse movement, and regulation of patient physiology and behavior. The course is designed to socialize the beginning nursing student to the professional role of nursing. Models of health care delivery systems and funding will be explored. Nursing issues regarding patient rights, ethical and legal standards, and the use of professional and therapeutic communication will be applied to nursing theory and practice. (CSU)

NURS 193 C Introduction to Medical-Surgical/ Gero Nursing 3.5 Units*Prerequisite: NURS 192 C.*

Term hours: 27 lecture and 108 laboratory. This course prepares the student to apply the nursing process and develop basic critical thinking within a spirit of inquiry firmly based in the science and art of nursing for safe patient centered care of the older adult in the medical-surgical setting. Students will recall and build upon curricular concepts (previously learned in N192) of patient centered care, safety, oxygenation, regulation and movement with healthy aging concepts and basic age-associated changes and preventive health considerations for the senior. Using interdisciplinary teamwork and collaboration, this course socializes the beginning nursing student to the professional role of nursing as it relates to the care of the older adult and explores informatics resources for evidence based practice. Models of health care delivery systems and for the senior will be explored as well as quality improvement strategies. Professional nursing issues regarding older adults rights, ethical and legal standards, and appropriate communication will be explored. (CSU)

NURS 195 C Pharmacology in Nursing II 1 Unit*Prerequisite: Acceptance in the Nursing Program, LVN, PT or completion of NURS 191 C and NURS 193 C.*

Term hours: 18 lecture. This pharmacology course correlates with the content in NURS 196 C and NURS 197 C. Students will recall and build upon the curricular concepts previously learned in NURS 191 C and NURS 193 C of patient centered care, teamwork and collaboration, professionalism, evidence based practice, quality improvement and informatics to safely administer both enteral and parenteral medications to patients in multiple settings with oxygenation, regulation and movement disorders. (CSU)

NURS 196 C Medical-Surgical Nursing I 5 Units*Prerequisite: NURS 191 C, and NURS 193 C.*

Term hours: 41 lecture and 148 laboratory. This course prepares the student to apply the nursing process and develop nursing judgment within a spirit of inquiry based on the science and art of nursing to prioritize care for the medical-surgical patient in multiple clinical settings. Students will recall and build upon previously learned curricular concepts of patient centered care, safety, oxygenation, regulation and movement using intra and interdisciplinary teamwork and collaboration, professionalism, evidence based practice, quality improvement and informatics to provide effective care to achieve positive patient outcomes. (CSU)

NURS 197 C Maternal/Newborn Nursing 3.5 Units*Prerequisite: NURS 196 C.*

Term hours: 32 lecture and 94 laboratory. This course prepares the student to apply the nursing process and develop nursing judgment to prioritize care for the perinatal, newborn and women's health patient in multiple clinical settings. Students will recall and build upon the curricular concepts (previously learned in N192 and N193 and 196) of patient centered care, safety, oxygenation, regulation and movement using teamwork and collaboration, professionalism, evidence-based practice, quality improvement and informatics to provide effective care to achieve positive patient outcomes. (CSU)

NURS 209 C Advanced RN Practicum and Career Development **1 to 4 Units**

Prerequisite: Successful completion of NURS 292 C.

Corequisite: Concurrent enrollment in the Registered Nursing Program or permission of the Director of Nursing.

Term hours: 9 lecture and 27 laboratory. This course focuses upon exploring work related issues in an acute hospital setting. The course will provide opportunities enabling students to apply previously learned theory and clinical skills in patient centered care in which the student has demonstrated competence. The course may provide exposure to acute areas of complex care with the agreement of the facility and instructor and previous enrollment in nursing practicum. Requires a minimum eight hours employment per week in an approved acute care agency. As required by the Board of Registered Nursing regulations, no new skills will be taught. Variable Unit Class. May be taken for credit 4 times. Pass/No Pass/Letter Grade Option. (CSU)

NURS 291 C Pharmacology in Nursing III **1 Unit**

Prerequisite: Acceptance in the Nursing Program, LVN, PT or completion of NURS 195 C, NURS 197 C.

Term hours: 18 lecture. This course correlates with the content in NURS 292 C, NURS 293 C, NURS 294 C. Students will recall and build upon the curricular concepts previously learned in NURS 195 C of patient centered care, teamwork and collaboration, professionalism, evidence based practice, quality improvement and informatics to safely administer medications to patients in multiple settings with oxygenation, regulation and movement disorders. (CSU)

NURS 292 C Medical-Surgical Nursing II **5 Units**

Prerequisite: NURS 195 C and NURS 197 C, and completion of or concurrent enrollment in NURS 196 C and acceptance in the Nursing Program.

Term hours: 41 lecture and 148 laboratory. This course prepares the student to apply the nursing process, to develop nursing judgment and to prioritize patient centered care for multiple acute medical surgical patients in a variety of settings. Students will apply quality and safety standards within a spirit of inquiry firmly based in the science and art of nursing. Students will recall and build upon the curricular concepts (previously learned in N192, N193, N196, and 197) of patient-centered care, safety, oxygenation, regulation and movement using teamwork and collaboration, professionalism, evidence based practice, quality improvement and informatics to provide effective care to achieve positive patient outcomes. (CSU)

NURS 293 C Mental Health Nursing **3.5 Units**

Prerequisite: NURS 292 C.

Term hours: 28 lecture and 95 laboratory. This course presents historical, cultural and contemporary evidence based concepts related to the mental health-illness continuum. Will explore patient-centered interventions that are designed to promote safe return to mental stability and meet the emotional needs of the patient. Emphasis is placed on interpersonal communication through self-awareness, the safe use of self as a therapeutic agent and collaboration with the mental health team and community resources. The role of the nurse in providing quality care in the areas of ethics, legal, advocacy issues while providing patient centered care is explored in the Psychiatric unit. (CSU)

NURS 294 C Geriatric Nursing **3 Units**

Prerequisite: NURS 292 C.

Term hours: 27 lecture and 81 laboratory. This course prepares the student to apply quality and safety standards and the National League for Nursing's ACES framework to plan patient centered care for the community dwelling older adult. There will be an emphasis on the use of standardized assessment tools and application of evidenced based practice in various community settings. Students will learn to collaborate with other members of the interdisciplinary team and use nursing judgement to foster individualized aging in the senior population. (CSU)

NURS 295 C Pharmacology in Nursing IV **.5 Units**

Prerequisite: Acceptance in the Nursing Program, LVN, PT or completion of NURS 291 C, NURS 292 C, NURS 293 C and NURS 294 C.

Term hours: 9 lecture. This course correlates with the content in NURS 296 C and NURS 297 C. Students will recall and build upon the curricular concepts learned in preceding nursing courses of patient centered care, safety, oxygenation and regulation and movement using teamwork and collaboration, professionalism, evidence based practice, quality improvement and informatics, to safely administer medications to pediatric and adult patients in multiple clinical settings with oxygenation, regulation and movement disorders. Pass/No Pass/Letter Grade Option (CSU)

NURS 296 C Child/Family Nursing **3.5 Units**

Prerequisite: NURS 291 C, NURS 292 C, NURS 293 C and NURS 294 C.

Term hours: 32 lecture and 95 laboratory. This course prepares the student to apply quality and safety standards utilizing the nursing process based in the science and art of nursing. Students will develop nursing care strategies for complex family centered care of the pediatric population within multiple interdisciplinary settings. Evidence based nursing interventions encompassing a holistic approach will be developed. The student will apply growth and development concepts to the care of multiple patients, utilizing informatics and effective therapeutic and professional communication. Nursing judgment and prioritization will be applied to achieve positive care outcomes within family centered care situations. The course promotes extensive inquiry through evidence based practice while developing teaching and quality improvement strategies. Emphasis will be placed on team accountability, delegation, collaboration and investment in professional development. (CSU)

NURS 297 C Medical-Surgical Nursing III **5 Units**

Prerequisite: NURS 292 C, NURS 295 C and NURS 296 C.

Term hours: 41 lecture and 149 laboratory. This course prepares the student to apply nursing process, to develop nursing judgment, and to prioritize care for adults with acute unstable medical-surgical disorders in a variety of settings. Students will recall and build upon the curricular concepts (previously learned in N192, N193, N196, N197, N292, N293, N294, N296) of patient-centered care, safety, oxygenation and regulation and mobility using teamwork and collaboration, professionalism, evidence based practice, quality improvement and informatics to provide effective care to promote synthesis and competence necessary for entry into practice. \$35.00 Material Fee-Payable at Registration. (CSU)

Office Administration

SEE — COMPUTER INFORMATION SYSTEMS FOR COMPUTER AND OFFICE APPLICATIONS DEGREE AND CERTIFICATE

Philosophy and Religious Studies

Division of Social Sciences

Division Dean — Lisa Gaetje, Interim

Faculty

Robert Cavin

Willis Heusser

Jason Thibodeau

Counselors

Therese Mosqueda-Ponce

Daniel Pelletier

PROGRAM LEARNING OUTCOMES (PLOs)

The courses taught by this department contribute to the General Education and Basic Skills Program Learning Outcomes. Please refer to General Education and Basic Skills Program Learning Outcomes.

ASSOCIATE IN ARTS IN PHILOSOPHY FOR TRANSFER DEGREE (AA-T)

Program Code: 1A32694

This curriculum is designed to provide an opportunity for the Philosophy major to achieve an Associate in Arts Degree in Philosophy for Transfer (AA-T in Philosophy) which completes the first and second year requirements for transfer to a four-year public California institution. While at least a baccalaureate degree is recommended preparation for those considering professional careers, completion of this curriculum will demonstrate commitment to the field and provide comprehensive preparation for further academic study through upper-division course work. Students should consult a counselor, the Transfer Center and the catalog of the transfer college or university to plan a specific program of study to meet the college or university's requirements.

Note: Courses that fulfill major requirements for an Associate Degree for Transfer at Cypress College might not be the same as those required for completing the major at all transfer institutions offering a Baccalaureate Degree. The Student Transfer Achievement Reform Act (Senate Bill 1440, now codified in California Education Code sections 66746–66749) guarantees admission to a California State University (CSU) campus for any community college student who completes an “associate degree for transfer,” a newly established variation of the associate degrees traditionally offered at a California community college. The AA-T is intended for students who plan to complete a bachelor's degree in a similar major at a CSU campus. Students completing these degrees (AA-T) are guaranteed admission to the CSU system, but not to a particular campus or major. Students transferring to a CSU campus that does accept the AA-T will be required to complete no more than 60 units after transfer to earn a bachelor's degree (unless the major is designated “high-unit” major). This degree may not be the best option for students intending to transfer to a particular CSU campus or to a university or college that is not part of the CSU system. Students should consult with a counselor when planning to complete the degree for more information on university admission and transfer requirements. This AA-T in Philosophy is designed to provide the student with a fundamental understanding and acquisition of knowledge in the Philosophy discipline. The study of philosophy includes:

(1) the development of critical thinking and writing skills; (2) the investigation of conceptual problems encountered in the course of reflecting about experience; (3) the assessment of assumptions underlying other sciences and arts; and (4) the exploration of intellectual and cultural history from a broad perspective. The curriculum includes courses in Ethics, Logic, and the History of Philosophy. Graduate study is important in Philosophy. Those holding a Master's or Doctoral Degree may find employment in education, law, journalism, health, business, theology, public service and other disciplines where analytical skills are required. A limited number of students who earn graduate degrees in philosophy go on to become college philosophy professors. Those without a graduate degree will find limited career opportunities in direct areas of Philosophy. Additionally, it is more challenging to obtain teaching and/or research opportunities without a terminal PhD degree or with M.A. degrees from less competitive institutions.

To earn an AA-T in Philosophy students must complete: (1) a minimum of 18 semester units or 27 quarter units in the Philosophy major with a minimum grade of “C”; (2) California State University General Education Breadth requirements (CSU GE Breadth) or the Intersegmental General Education Transfer Curriculum (CSU IGETC); (3) completion of 60 semester units of CSU transferable course work; and (4) have an overall GPA of 2.0.

Core Courses (6 units)

Choose 2 courses:

| | | Units |
|------------|---|-------|
| PHIL 175 C | Symbolic Logic and | 3 |
| PHIL 100 C | Introduction to Philosophy or | 3 |
| PHIL 100HC | Honors Introduction to Philosophy or | (3) |
| PHIL 160 C | Introduction to Ethics | (3) |

List A (3 units)

Any course not selected from Core, or 1 course from list below:

| | | Units |
|------------|-------------------------------|-------|
| PHIL 170 C | Logic and Critical Thinking | 3 |
| PHIL 201 C | History of Ancient Philosophy | 3 |
| PHIL 202 C | History of Modern Philosophy | 3 |

List B (6 units)

Any course not selected from List A, or 2 courses from list below:

| | | Units |
|------------|-----------------------------------|-------|
| PHIL 101 C | Introduction to Religious Studies | 3 |
| PHIL 135 C | Social and Political Philosophy | 3 |
| HIST 110 C | Western Civilizations I or | 3 |
| HIST 110HC | Honors Western Civilizations I | (3) |
| HIST 111 C | Western Civilizations II or | 3 |
| HIST 111HC | Honors Western Civilizations II | (3) |

List C (3 units)

Any course not selected from List A or List B.

| | | |
|--|--|---|
| | | 3 |
|--|--|---|

Total Units Required

18

**ASSOCIATE IN ARTS DEGREE
PHILOSOPHY**

Program Code: 1A16881

The Associate in Arts Degree in Philosophy is designed to develop the reasoning skills needed to understand and evaluate theories about society, persons, reality, knowledge, truth, values, etc. The purpose of which is to uncover the assumptions underlying our understanding of the world and to subject those assumptions to careful scrutiny using the tools of logic. Upon successful completion, students will understand the major concepts and issues that have shaped philosophical traditions and be able to make decisions based on rigorous, logical standards. Skills in thinking and problem solving, research, writing, criticism, and analysis are emphasized. This will include the ability to critically analyze the logical structure of arguments in contemporary social and moral issues and to assess the influential positions on theories of truth and the nature of reality. The precision of thought and expression that philosophy requires makes excellent preparation for a variety of careers. Those who do well in philosophy can expect to think more clearly and logically and to approach problems and issues more systematically. Graduate study is important in Philosophy. Those holding a Master's or Doctoral Degree may find employment in education, law, journalism, health, business, theology, public service and other disciplines where analytical skills are required. A limited number of students who earn graduate degrees in philosophy go on to become college philosophy professors. Those without a graduate degree will find limited career opportunities in direct areas of Philosophy. Courses that fulfill major requirements for an associate degree at Cypress College might not be the same as those required for completing the major at a transfer institution offering a baccalaureate degree.

The Associate in Arts Degree in Philosophy will provide students with an introduction to the field including its analytic foundations and applied areas. The degree curriculum and major provide a sound foundation for transfer students intending further upper-division study as preparation for the baccalaureate degree.

To earn an Associate Degree students must complete: (1) all major course requirements with a minimum grade of "C"; (2) California State University General Education Breadth requirements (CSU GE Breadth) or IGETC general education plan; (3) any elective courses to complete a minimum of 60 units; (4) complete all graduation requirements; and, (5) have an overall GPA of 2.0. At least 50% of all major course work must be completed at Cypress College. Students pursuing more than one specified departmental major may double count a maximum of 7 units to fulfill major requirements.

Courses that fulfill major requirements for an Associate Degree at Cypress College might not be the same as those required for completing the major at a transfer institution offering a Baccalaureate Degree. For information on specific university requirements, please consult with your counselor, or visit the Transfer Center.

Take 6 units (and 6 units from Method Courses) or take 9 units (and 3 units from Method Courses). Required courses are listed in suggested sequence:

| Course # | Title | Units |
|------------|-----------------------------------|-------|
| PHIL 100 C | Introduction to Philosophy | 3 |
| | or | |
| PHIL 100HC | Honors Introduction to Philosophy | (3) |
| PHIL 160 C | Introduction to Ethics | 3 |
| PHIL 201 C | History of Ancient Philosophy | 3 |
| PHIL 202 C | History of Modern Philosophy | 3 |

Three (3) to Six (6) units from the following Philosophy Required Method Courses:

| | | |
|------------|-------------------------------|---|
| PHIL 170 C | Logic and Critical Thinking | 3 |
| PHIL 172 C | Critical Thinking and Writing | 3 |
| PHIL 175 C | Symbolic Logic | 3 |

Three (3) units from the following Philosophy Elective Courses:

| | | |
|------------|-----------------------------------|---|
| PHIL 101 C | Introduction to Religious Studies | 3 |
| PHIL 110 C | Religions of the East | 3 |
| PHIL 120 C | Religions of the West | 3 |
| PHIL 240 C | Jesus and His Interpreters | 3 |
| PHIL 230 C | Philosophy of Religion | 3 |

Three (3) to four (4) units from the following Elective Courses:

| | | |
|---------------------|--|-----|
| ANTH 102 C | Cultural Anthropology | 3 |
| ART 100 C | Fundamentals of Art | 3 |
| ENGL/INDS 110/100 C | Humanities: Ancient and Medieval | 3 |
| ENGL/INDS 111/101 C | Humanities: Renaissance–Present | 3 |
| MATH 030 C | Plane Geometry | 4 |
| MUS 116 C | Music Appreciation | 3 |
| PHYS 130 C | Elementary Physics | 4 |
| POSC 120 C | Political Theory | 3 |
| *POSC 215 C | Comparative Politics | 3 |
| **PSY 101 C | Introduction to Psychology | 3 |
| | or | |
| **PSY 101HC | Honors Introduction to Psychology | (3) |
| PSY 120 C | Human Sexuality | 3 |
| PSY 161 C | Probability and Statistics — Social Sciences | 4 |
| PSY 221 C | The Brain and Behavior | 3 |
| SOC 101 C | Introduction to Sociology | 3 |
| | or | |
| SOC 101HC | Honors Introduction to Sociology | (3) |
| THEA 100 C | Introduction to the Theater | 3 |

Total Units Required 18

*A score of 3 or higher on the Advanced Placement (AP) Government and Politics (Comparative) exam meets this requirement upon petition through Admissions and Records. See a counselor for more information.

**A score of 3 or higher on the Advanced Placement (AP) Psychology exam meets this requirement upon petition through Admissions and Records. See a counselor for more information.

**PHILOSOPHY AND RELIGIOUS STUDIES
TRANSFER PROGRAM**

Students should consult a counselor or www.assist.org for lower division major requirements for most California public universities. (See the Standard Definitions section of the catalog for a description of ASSIST.) Students transferring to an independent college/university should consult the catalog of the individual school and a counselor for lower division major requirements.

Philosophy and Religious Studies (PHIL)

PHIL 100 C Introduction to Philosophy 3 Units

Advisory: Eligibility for ENGL 100 C.

Term hours: 54 lecture. This course introduces the student to a variety of philosophical issues in metaphysics, theory of knowledge, and ethics, as well as the methodology used by philosophers to address those issues. The origins of Western philosophy as well as its impact on Western civilization will be emphasized. The course systematically explores and evaluates the concepts of reality, value, knowledge, reason, truth, language, definition, beauty, justice, human nature, personal identity, religion, meaning, and freedom. Analysis and synthesis will be stressed for these and other topics of interest to students and/or the instructor. Duplicate credit not granted for PHIL 100HC. (UC Credit Limitation/CSU, AA GE, CSU GE, IGETC, C-ID: PHIL 100)

PHIL 100HC Honors Introduction to Philosophy 3 Units

Advisory: Eligibility for ENGL 100 C.

Term hours: 54 lecture. This course is enhanced for honors students. It introduces the student to a variety of philosophical issues in metaphysics, theory of knowledge, and ethics, as well as the methodology used by philosophers to address those issues. The origins of Western philosophy as well as its impact on Western civilization will be emphasized. The course systematically explores and evaluates the concepts of reality, value, knowledge, reason, religion, meaning, and freedom. Analysis and synthesis will be stressed for these and other topics of interest to students and/or the instructor. Duplicate credit not granted for PHIL 100 C. (UC Credit Limitation/CSU, AA GE, CSU GE, IGETC, C-ID: PHIL 100)

PHIL 101 C Introduction to Religious Studies 3 Units

Advisory: Eligibility for ENGL 100 C.

Term hours: 54 lecture. This course is an introductory study of religion with emphasis on the origins and functions of religion, religious experience, and religious and theological modes of expression. Course content will be drawn from Eastern and Western traditions, ancient, medieval and modern times. (UC/CSU, AA GE, CSU GE, IGETC)

PHIL 110 C Religions of the East 3 Units

Advisory: Eligibility for ENGL 100 C.

Term hours: 54 lecture. This course systematically introduces and analyzes the intellectual and religious histories of India, China, and Japan. Primary focus will be on the ways in which Eastern traditions such as Hinduism, Buddhism, Confucianism, Taoism, and Zen conceive of the cosmos, meaningful human existence and life's ultimate goals. Jainism, Sikhism, and Shinto may also be covered. While the main emphasis will be on basic teachings, this course will also investigate religious practices, cultural settings, social impact, and the historical contexts in which these religions arose. Rituals and religious literature may be used to compare and contrast Asian and Occidental belief systems. A field trip may be required by the instructor. (UC/CSU, AA GE, CSU GE, IGETC)

PHIL 120 C Religions of the West 3 Units

Advisory: Eligibility for ENGL 100 C.

Term hours: 54 lecture. This course is an introduction to Zoroastrianism, Judaism, Christianity, and Islam, as well as the religions of ancient Mesopotamia, Canaan, and Egypt. The history, beliefs, rituals, literature, and art of each religion will be examined with a goal to discovering its conception of God, man, the cosmos, meaningful human existence, and life's ultimate goals. Skills in objective, scholarly analysis of the scripture of each religion will be developed. Religious trends in the Nineteenth and Twentieth Centuries and contemporary secular and religious humanism will be discussed. A field trip may be required by the instructor. (UC/CSU, AA GE, CSU GE, IGETC)

PHIL 135 C Social and Political Philosophy 3 Units

Advisory: Eligibility for ENGL 100 C.

Term hours: 54 lecture. This course is an introduction to social and political thought, especially the central concepts (e.g. democracy, justice, rights, liberty, political authority, political morality, etc.) and issues that arise in classic and contemporary readings. The course involves an examination of the relationship between morality, politics and social justice, from a multi-cultural perspective. Topics include: the sources of legitimate political authority, the meaning of democracy, obligations of citizenship, the nature of the state, the justifications for universal human rights, the foundations of a just society, and how political culture is related to social and political institutions. (UC/CSU, AA GE, CSU GE, IGETC)

PHIL 160 C Introduction to Ethics 3 Units

Advisory: Eligibility for ENGL 100 C.

Term hours: 54 lecture. This course is an introduction to metaethics, normative ethics, and applied ethics. Fundamental ethical concepts, theories, and arguments in classical, medieval, modern, and contemporary ethical thought are presented, analyzed, and critically evaluated. (UC/CSU, AA GE, CSU GE, IGETC, C-ID: PHIL 120)

PHIL 170 C Logic and Critical Thinking 3 Units

Advisory: Eligibility for ENGL 100 C.

Term hours: 54 lecture. This course focuses on elements of clear, straight, orderly and valid thought, including deductive and inductive reasoning and the accurate use of language. This course explores practical applications of logic. (UC/CSU, AA GE, CSU GE)

PHIL 172 C Critical Thinking and Writing 3 Units

Prerequisite: ENGL 100 C with a minimum grade of "C".

Term hours: 54 lecture. This course is an introduction to the techniques of argument analysis, evaluation, and construction as applied to essay writing. The course includes such topics as standard form and argument patterns; deduction, validity, and soundness; truth-functional arguments, truth-tables, and natural deduction; quantificational arguments; categorical syllogisms and Venn Diagrams; truth; induction, strength, and cogency; sampling arguments, causal arguments, statistical syllogisms, analogical arguments, and explanatory arguments; the probability calculus; formal and informal fallacies; and definition, language, and meaning; thesis statements, the writing of coherent, well-developed essays, and grammar, punctuation, and orthography. (UC/CSU, AA GE, CSU GE, IGETC)

PHIL 175 C Symbolic Logic 3 Units

Advisory: Eligibility for ENGL 100 C.

Term hours: 54 lecture. This is a course in elementary, truth-functional, propositional logic and first-order quantificational predicate logic, up through identity and definite descriptions. The course covers the techniques for the translation of English statements and arguments into formal logical languages and the methods for determining whether these arguments are valid. (UC/CSU, CSU GE, C-ID: PHIL 210)

PHIL 201 C History of Ancient Philosophy 3 Units

Advisory: Eligibility for ENGL 100 C.

Term hours: 54 lecture. This historical introduction to philosophy traces the development of Western philosophy with a focus on the early Greeks, emphasizing those ideas which have most influenced the development of Western culture. This course will explore the birth of European thought with the Pre-Socratics, such as the Milesian philosophers and Greek atomists, then move to Athens with Socrates, Plato, and Aristotle, and continue with some philosophers from the Hellenistic and Medieval periods. This course surveys the development, transformation, and influence of Greek metaphysics, epistemology, and ethics within the context of their historical and cultural setting. Particular focus will be placed on the philosophical issues still facing us now, including the perennial search for values. (UC/CSU, AA GE, CSU GE, IGETC, C-ID: PHIL 130)

PHIL 202 C History of Modern Philosophy 3 Units

Advisory: Eligibility for ENGL 100 C.

Term hours: 54 lecture. This is a survey of Western philosophical thought since the Renaissance with emphasis on the Modern period. The course introduces students to some of the most important and influential philosophical themes as they found expression in its most central figures. It emphasizes metaphysics and epistemology, but may also include the development of views in ethics, political philosophy, God's existence, skepticism, causality, logic, semantics, and philosophical foundations of modern science. The course also examines the influence of past philosophical movements on modern life, including the growth of science and social and cultural changes. (UC/CSU, AA GE, CSU GE, IGETC, C-ID: PHIL 140)

PHIL 230 C Philosophy of Religion 3 Units

Advisory: Eligibility for ENGL 100 C.

Term hours: 54 lecture. This course critically examines the central arguments for and against the existence of God, the historicity of miracles, and the possibility of life after death. (UC/CSU, AA GE, CSU GE, IGETC)

PHIL 240 C Jesus and His Interpreters 3 Units

Advisory: Eligibility for ENGL 100 C.

Term hours: 54 lecture. This course focuses upon the ways in which Jesus is depicted in the Gospels and critically reconstructed in New Testament scholarship, with a view to determining what can be known historically regarding Jesus' teaching and life. (UC/CSU, CSU GE, IGETC)

PHIL 298 C Philosophy Seminar .5 to 12 Units

Prerequisite: May be required.

Corequisite: May be required.

Advisory: May be required.

Term hours: 0-216 lecture and/or 0-432 laboratory depending on units attempted. This is a lecture/discussion type course developed on a particular limited problem or topic of interest to students. It is designed for able students who wish to increase their knowledge of a particular topic concerning which no other regular class is offered. A paper or group activity may be requested. Credit may range from 1/2 unit to 12 units. Consult class schedule for the offerings a particular semester. May be taken for credit 1-4 times. Pass/No or Pass/No Pass/Letter Grade Option or Standard Letter Grade. Fees may be required-Payable at Registration. (UC Credit Limitation/CSU)

PHIL 299 C Philosophy Independent Study 1 Unit

Prerequisite: Approved Independent Study Learning Contract.

Varying hours of scheduled conferences per week according to instructor. Independent study is for able students who wish to extend their knowledge of a particular area through individual research and study. It is thought that topics might develop out of a curiosity stimulated in a regular class. The student would then contact the supervising instructor to develop a contract for his/her particular interest so that they could learn more regarding their special topic. May be taken for credit 3 times. (UC Credit Limitation/CSU)

Photography

Division of Fine Arts

Division Dean — Katy Realista

Faculty

Clifford Lester

Counselors

Renay Laguana-Ferinac

Renee Ssensalo

PROGRAM LEARNING OUTCOMES (PLOs)

A student who completes the Photography program of study will be able to:

- Produce photographic images utilizing a variety of photographic processes.
- Develop and create a portfolio of images centered on a single theme or idea.
- Possess the technical skills necessary to create professional quality photographs in both studio and location environments.
- Possess an understanding of how issues and concepts are related to the processes used to communicate them.

ASSOCIATE IN ARTS DEGREE

PHOTOGRAPHY

Program Code: 1A03782

This program is designed to prepare students for entry into occupational photographic fields. A student may also elect to work toward a transfer into a four-year institution, in the field of Fine Arts.

To earn an Associate Degree students must complete: (1) all major course requirements with a minimum grade of "C"; (2) 25 units of General Education Graduation Requirements; (3) the cultural diversity and reading requirements; (4) any elective courses to complete a minimum of 60 units; and, (5) have a minimum GPA of 2.0. At least 50% of all major course work must be completed at Cypress College.

Courses that fulfill major requirements for an Associate Degree at Cypress College might not be the same as those required for completing the major at a transfer institution offering a Baccalaureate Degree. For information on specific university requirements, please consult with your counselor, or visit the Transfer Center.

| Required courses are listed in suggested sequence: | | Units |
|---|---------------------------------------|--------------|
| PHOT 101 C | Introduction to Photography | 3 |
| PHOT 103 C | Intermediate Photography | 3 |
| PHOT 104 C | Wedding and Event Photography | 3 |
| PHOT 109 C | Portrait Photography | 3 |
| PHOT 200 C | Conceptual Photography | 3 |
| PHOT 201 C | Introduction to Professional Photo | 3 |
| PHOT 202 C | Contemporary Photography | 3 |
| PHOT 203 C | Studio Lighting Techniques | 3 |
| PHOT 204 C | History and Aesthetics of Photography | 3 |
| PHOT 209 C | Careers in Photography | 3 |
| PHOT 215 C | Digital Photography | 3 |
| PHOT 216 C | Advanced Digital Photography | 3 |
| PHOT 219 C | Editorial Photography | 3 |
| PHOT 227 C | Retouching and Digital Workflow | 3 |

| Electives: choose one course listed below | | Units |
|--|--|--------------|
| PHOT 118 C | Available Light Photography | 3 |
| PHOT 206 C | Studio Practices | 3 |
| PHOT 106 C | Advanced Wedding Photography | 3 |
| PHOT 110 C | About Faces: Portraiture | 3 |
| PHOT 230 C | Advanced Retouching and Digital Workflow | 3 |
| Total Units Required | | 45 |

ADVERTISING AND ILLUSTRATIVE PHOTOGRAPHY CERTIFICATE

Program Code: 1C15692

The Advertising and Illustrative Photography Certificate is designed to prepare students for starting their own photography business or for employment within the advertising industry.

To earn a certificate, students must complete the required courses as listed with a minimum grade of "C." At least 50% of all course work must be completed at Cypress College.

Required courses are listed in suggested sequence:

| Course # | Title | Units |
|-----------------------------|------------------------------------|--------------|
| PHOT 103 C | Intermediate Photography | 3 |
| PHOT 201 C | Introduction to Professional Photo | 3 |
| PHOT 203 C | Studio Lighting Techniques | 3 |
| PHOT 206 C | Studio Practices | 3 |
| PHOT 209 C | Careers in Photography | 3 |
| PHOT 215 C | Digital Photography | 3 |
| Total Units Required | | 18 |

CREATIVE PHOTO ARTS CERTIFICATE

Program Code: 1C15691

The Creative Photo Arts Certificate is designed to prepare students for a career as an individual artist or as an employee in the visual arts.

To earn a certificate, students must complete the required courses as listed with a minimum grade of "C." At least 50% of all course work must be completed at Cypress College.

Required courses are listed in suggested sequence:

| Course # | Title | Units |
|-----------------|-----------------------------|--------------|
| PHOT 200 C | Conceptual Photography | 3 |
| PHOT 202 C | Contemporary Photography | 3 |
| PHOT 118 C | Available Light Photography | 3 |
| PHOT 215 C | Digital Photography | 3 |

Electives:

| Select a minimum of 3 units from the electives listed below: | | Units |
|---|---------------------------------------|--------------|
| PHOT 220 C | Alternative Photo Processes I | 3 |
| PHOT 204 C | History and Aesthetics of Photography | 3 |
| Total Units Required | | 15 |

DIGITAL PHOTOGRAPHY CERTIFICATE

Program Code: 1C12978

The Digital Photography Certificate is designed to prepare the student for entry-level employment within the Photo Lab/Service Bureau Industry. Students are trained in the use of state-of-the-art printing and processing equipment.

To earn a certificate, students must complete the required courses as listed with a minimum grade of "C." At least 50% of all course work must be completed at Cypress College.

Required courses are listed in suggested sequence:

| Course # | Title | Units |
|-----------------|------------------------------|--------------|
| PHOT 101 C | Introduction to Photography | 3 |
| PHOT 103 C | Intermediate Photography | 3 |
| PHOT 215 C | Digital Photography | 3 |
| PHOT 216 C | Advanced Digital Photography | 3 |

Select 3 units from the electives below:

| Select 3 units from the electives below: | | Units |
|---|-----------------------------------|--------------|
| PHOT 227 C | Digital Capture Workflow | 3 |
| PHOT 230 C | Advanced Digital Capture Workflow | 3 |
| Total Units Required | | 15 |

DIGITAL PHOTO TECHNICIAN CERTIFICATE

Program Code: 1C30327

This certificate is a comprehensive series of courses designed to prepare students for employment in the profession of Digital Photo Technician. Courses will include in depth study of color, high end digital camera operation, computer technology, digital capture workflow, studio lighting, and studio set etiquette.

Required courses are listed in numeric sequence:

| Course # | Title | Units |
|-----------------------------|-----------------------------------|--------------|
| PHOT 103 C | Intermediate Photography | 3 |
| PHOT 203 C | Studio Lighting Techniques | 3 |
| PHOT 215 C | Digital Photography | 3 |
| PHOT 216 C | Advanced Digital Photography | 3 |
| PHOT 227 C | Digital Capture Workflow | 3 |
| PHOT 230 C | Advanced Digital Capture Workflow | 3 |
| Total Units Required | | 18 |

PHOTOGRAPHY CERTIFICATE

Program Code: 1C21111

The certificate program in photography allows the student to prepare for entry into an occupational photographic field.

To earn a certificate, complete the required courses listed below, plus 6 additional units from the list of suggested electives listed below with a minimum grade of "C." At least 50% of all course work must be completed at Cypress College.

Required courses are listed in suggested sequence:

| Course # | Title | Units |
|-----------------|------------------------------------|--------------|
| PHOT 101 C | Introduction to Photography | 3 |
| PHOT 103 C | Intermediate Photography | 3 |
| PHOT 109 C | Portrait Photography | 3 |
| PHOT 201 C | Introduction to Professional Photo | 3 |
| PHOT 209 C | Careers in Photography | 3 |
| PHOT 215 C | Digital Photography | 3 |

Electives:

| Select a minimum of 6 units from the electives below: | | Units |
|--|-------------------------------|--------------|
| PHOT 216 C | Advanced Digital Photography | 3 |
| PHOT 118 C | Available Light Photography | 3 |
| MGT 161 C | Introduction to Business | 3 |
| MGT 266 C | Human Relations in Business | 3 |
| MKT 103 C | Principles of Advertising | 3 |
| MKT 208 C | Principles of Selling | 3 |
| MGT 261 C | Small Business Management | 3 |
| ART 120 C | Two-Dimensional Design | 3 |
| PHOT 104 C | Wedding and Event Photography | 3 |
| Total Units Required | | 24 |

PORTRAIT AND WEDDING PHOTOGRAPHY CERTIFICATE **Program Code: 1C12984**

The Portrait and Wedding Photography Certificate is designed to prepare students for starting their own business or for employment within the wedding/portrait industry.

To earn a certificate, students must complete the required courses as listed with a minimum grade of "C." At least 50% of all course work must be completed at Cypress College.

| Required courses are listed in numeric sequence: | | Units |
|---|-------------------------------|--------------|
| PHOT 103 C | Intermediate Photography | 3 |
| PHOT 104 C | Wedding and Event Photography | 3 |
| PHOT 109 C | Portrait Photography | 3 |
| PHOT 209 C | Careers in Photography | 3 |
| PHOT 215 C | Digital Photography | 3 |
| Total Units Required | | 15 |

UAV/UAS DRONE PHOTOGRAPHY AND VIDEO CERTIFICATE **Program Code: 1C35421**

This certificate program will provide students with extensive knowledge of the quickly growing UAV / UAS Drone industry. Students will learn everything from equipment selection and operation, to aerial photography and video. They will gain experience flying drones and learn safety as well as operational techniques. Finally, they will become familiar with the many job opportunities that await an experienced drone operator and photographer. To earn this certificate, complete the required courses as listed with a minimum grade of "C." At least 50% of all major course work must be completed at Cypress College.

| Required Courses | | Units |
|-------------------------|------------------------------|--------------|
| ATC 160 C | UAV/UAS Basic | 3 |
| ATC 161 C | UAV/UAS Basic Simulator | 1 |
| PHOT 101 C | Introduction to Photography | 3 |
| PHOT 103 C | Intermediate Photography | 3 |
| PHOT 235 C | Drone Photography and Video | 3 |
| PHOT 236 C | UAV Flight Lab - Photography | 2 |
| Total Units | | 15 |

PHOTOGRAPHY TRANSFER PROGRAM

Students should consult a counselor or www.assist.org for lower division major requirements for most California public universities. (See the Standard Definitions section of the catalog for a description of ASSIST.) Students transferring to an independent college/university should consult the catalog of the individual school and a counselor for lower division major requirements.

Photography (PHOT)

PHOT 050 C Photography Special Projects **3 Units**
Advisory: PHOT 103 C.

Term hours: 36 lecture and 72 laboratory TBA. Designed to allow the student to specialize in one particular phase of photography under the close supervision of the instructor. Students will be required to meet periodic deadlines and do some classroom assignments that are loosely structured to allow creativity. This should be the final class that the student takes before leaving the photography program. \$20.00 Material Fee-Payable at Registration.

PHOT 101 C Introduction to Photography **3 Units**

Term hours: 36 lecture and 72 laboratory TBA. This course provides students with an introduction to visual concepts, basic image capture and camera functions with film and digital cameras. Software basics for photographic imaging and digital printing, along with traditional black and white darkroom printing will be taught. Assignments will require the use of both film and digital SLR cameras. \$35.00 Material Fee-Payable at Registration. Credit by Examination. (UC/CSU, AA GE, CSU GE)

PHOT 103 C Intermediate Photography **3 Units**

Advisory: PHOT 101 C.
Term hours: 36 lecture and 72 laboratory TBA. This course is designed to reinforce and enhance the concepts and skills acquired in the Introduction to Photography class. The emphasis will be on the refinement of basic technical skills including traditional and digital image processing and printing, digital and film camera operation, industry standard digital image editing software techniques, and the development of a personal direction in photography for each student. In order to increase the student's exposure to the medium, the course also includes an introduction to large format cameras and studio lighting. \$35.00 Material Fee-Payable at Registration. (CSU)

PHOT 104 C Wedding and Event Photography **3 Units**

Advisory: PHOT 103 C.
Term hours: 36 lecture and 72 laboratory TBA. This introductory course is designed to introduce students to the skills and mindset needed to photograph weddings and events in the second shooter role. The course is composed of lectures, lab time and outside assignments, which will prepare the students for basic application in this field of photography. \$35.00 Materials Fee - Payable at Registration. (CSU)

PHOT 106 C Advanced Wedding Photography **3 Units**

Advisory: PHOT 103 C and PHOT 104 C.
Term hours: 36 lecture and 72 laboratory TBA. This advanced course is designed to prepare photographers for a career in professional wedding photography. It focuses on building the technical and creative photographic skills necessary to successfully photograph a wedding event as the main shooter. The course is composed of lectures, demos, lab time and outside assignments which will prepare the students for advanced application in this field of photography. \$ 35.00 Materials Fee - Payable at Registration. (CSU)

PHOT 109 C Portrait Photography **3 Units**

Advisory: PHOT 103 C.
Term hours: 36 lecture and 54 laboratory TBA. This course is designed to give the student a working knowledge of portrait styles and techniques. The student will practice techniques for photographing people in a studio and on location situation. The student will work with both natural and artificial lighting and learn the possibilities and limitations of both. Emphasis will be placed on lighting styles and patterns, as well as working with people in front of the camera. Students will have an opportunity to investigate and imitate the styles of well-known portrait photographers. \$20.00 Material Fee-Payable at Registration. (CSU)

PHOT 110 C About Faces: Portraiture **3 Units**

Advisory: PHOT 103 C.
Term hours: 36 lecture and 72 laboratory TBA. This course is designed to give the student a working knowledge of the specialty areas in the field of portraiture today. The student will learn techniques for creating portraiture in the following areas: newborns, expectant mothers, families, children, high school seniors, pets, headshots and boudoir/pin ups. Using 35 mm digital or film cameras, natural and studio lighting, the student will produce interesting and creative portraits and have the opportunity to see which types of portraiture appeals to them the most. \$35.00 Materials Fee - Payable at Registration. (CSU)

PHOT 118 C Available Light Photography 3 Units*Advisory: PHOT 101 C and PHOT 103 C.*

Term hours: 36 lecture and 72 laboratory TBA. This course is designed to give the student knowledge of and competency in making photographic images in available light conditions where light cannot be rigidly controlled. Combining lighting awareness with photographic techniques, the course concentrates on the creation of photographs made under a variety of lighting conditions found in both natural and man-made environments. Topics include learning how to see and control light, selection and care of equipment, use of filters, techniques for photographing both at night as well as challenging times during the day, and procedures for photographing indoors with supplemental strobe equipment. \$35.00 Materials Fee - Payable at Registration. (CSU)

PHOT 200 C Conceptual Photography 3 Units*Advisory: PHOT 101 C and ART 100 C.*

Term hours: 36 lecture and 72 laboratory TBA. This course is designed to give the students the tools and techniques to create work that communicates complex concepts visually. The student will become familiar with significant contemporary photographers and conceptual artists whose own works employ strong idea-based imagery. Assignments will focus on the importance of why conceptual photographs are created and the success of what they communicate. This class culminates in a site-specific installation or group exhibition of the students' own conceptually based works. \$20.00 Material Fee-Payable at Registration. (CSU)

PHOT 201 C Introduction to Professional Photo 3 Units*Advisory: PHOT 103 C.*

Term hours: 36 lecture and 72 laboratory TBA. This is an introductory course dealing with the production of photographs for advertising and editorial use. Emphasis will be placed on studio and location lighting techniques, as well as the conceptual validity of photographs for industry applications. \$20.00 Material Fee-Payable at Registration. (CSU)

PHOT 202 C Contemporary Photography 3 Units*Advisory: PHOT 101 C and ART 100 C.*

Term hours: 36 lecture and 72 laboratory TBA. This is a lecture and lab course on the genre of contemporary photography from the 1970's to present day. The historical significance of contemporary photographers including the impact from the conceptual art movement on photography will be explored in this course. The need for strong idea-based photographs in all aspects of photographic industries is emphasized. Assignments will focus on the importance of why photographs are created and the success of what they communicate. \$20.00 Material Fee - Payable at Registration. (UC Credit Limitation/CSU)

PHOT 203 C Studio Lighting Techniques 3 Units*Advisory: PHOT 103 C.*

Term hours: 36 lecture and 72 laboratory TBA. This course acquaints the student with lighting and studio techniques as commonly used in professional photographic applications. The emphasis will be on light and the use of lighting equipment in a photography studio. \$20.00 Material Fee-Payable at Registration. (CSU)

PHOT 204 C History and Aesthetics of Photo 3 Units*Advisory: PHOT 103 C.*

Term hours: 36 lecture and 72 laboratory TBA. This is a lecture/lab course on the history of photography that is designed to give students a practical knowledge of the development of the medium through a combination of lecture and hands-on technical and aesthetic experiences utilizing early photographic techniques and processes. The course will emphasize the invention and development of photography from its inception in the early 1800's through 1970. \$20.00 Material Fee-Payable at Registration. (UC/CSU)

PHOT 206 C Studio Practices 3 Units*Advisory: PHOT 103 C.*

Term hours: 36 lecture and 72 laboratory TBA. This is a course designed to familiarize the student with image conceptualization and the differing technical alternatives used in commercial studio photography. Students will learn specialized imaging techniques utilized by professional studio photographers. \$20.00 Materials Fee-Payable at Registration. (CSU)

PHOT 209 C Careers in Photography 3 Units*Advisory: PHOT 103 C.*

Term hours: 36 lecture and 72 laboratory TBA. This course is designed to help students identify and achieve professional goals and objectives. The course will provide an understanding of the various career options within the field and the level of professional preparation that is necessary in order to get established in a particular career area. Topics will include the technical skills, equipment, portfolio development, promotional needs and specialized business considerations necessary for getting a job or establishing a photographic business. \$20.00 Material Fee-Payable at Registration. (CSU)

PHOT 211 C Film Photography 3 Units*Advisory: PHOT 103 C.*

Term hours: 36 lecture and 72 laboratory TBA. This is a course emphasizing exposure control as well as film processing and printing techniques. Techniques for the control of final image quality under normal and adverse lighting conditions will be explored. \$35.00 Materials Fee - Payable at Registration. (CSU)

PHOT 215 C Digital Photography 3 Units*Advisory: PHOT 103 C.*

Term hours: 36 lecture and 72 laboratory TBA. This course is designed to integrate digital imaging into the advanced photography student's visual repertoire. Combining creative studio/camera practices with computer technology, the course concentrates on the production and processing of images with current digital media to all areas of photography (commercial, illustration, portraiture, journalism, industrial, scientific, etc.). Included are techniques for background control, selection and manipulation, digitization, image capture and processing. \$45.00 Materials Fee-Payable at Registration. (CSU)

PHOT 216 C Advanced Digital Photography 3 Units*Prerequisite: PHOT 215 C or consent of Instructor.**Advisory: PHOT 103 C.*

Term hours: 36 lecture and 72 laboratory TBA. This course is designed to provide the student with advanced knowledge of techniques and skills in the application of digital technologies to all areas of the photographic medium. The integration of technical skills and aesthetic expression will be emphasized along with color management and advanced skills in preparing images for output on large format printers. Students develop the skills necessary to create their own unique body of work using digital photographic technologies. \$35.00 Material Fee - Payable at Registration. (CSU)

PHOT 217 C 3D Photo Imaging 3 Units*Prerequisite: PHOT 103 C with a grade of "C" or better.*

Term hours: 36 lecture and 72 laboratory TBA. This course is designed to provide the student with advanced knowledge of 3D photographic imaging technologies as they relate to the study of light, form, and three-dimensional space. Students will study lighting, form, and space in virtual environments of their own creation. A diverse assortment of 3D software will be utilized to instruct students in how forms are visually perceived and modified based on the way light describes them. The relationship between 2D and 3D imaging applications will be discussed as well as the integration of the two for a variety of commercial photography and multimedia applications. These include studio background creation, special visual effects, game production, photo illustration, and digital composites. \$35.00 Materials Fee-Payable at Registration. (CSU)

PHOT 219 C Editorial Photography 3 Units*Advisory: PHOT 103 C.*

Term hours: 36 lecture and 72 laboratory TBA. This course is designed to acquaint the student with a current view of the field of photojournalism and photographic publishing for magazines, the Internet, and all editorial uses. Heavy emphasis is placed on communication through photography. \$20.00 Material Fee-Payable at Registration. (CSU)

PHOT 220 C Alternative Photo Processes I 3 Units*Prerequisite: PHOT 101 C with a minimum grade of "C".**Advisory: PHOT 103 C.*

Term hours: 36 lecture and 72 laboratory TBA. This class will investigate the artistic aspects and technical procedures used in 19th Century photographic printing of hand coated papers. Class projects will include aspects of graphic arts photography, films and developers. During the semester, students will work with cyanotypes, kallitypes and gum printing. \$45.00 Material Fee-Payable at Registration. (CSU)

PHOT 221 C Alternative Photo Processes II 3 Units*Prerequisite: PHOT 220 C with a minimum grade of "C".*

Term hours: 36 lecture and 72 laboratory TBA. This class will continue to investigate the artistic aspects and technical procedures used in 19th Century photographic printing of hand coated papers. During the semester students will work with van dyke, salted paper, albumen and collodian. \$45.00 Materials Fee - Payable at Registration. (CSU)

PHOT 222 C Alternative Photo Processes III 3 Units*Prerequisite: PHOT 221 C with a minimum grade of "C".*

Term hours: 36 lecture and 72 laboratory TBA. This class will continue to investigate the artistic aspects and technical procedures used in 19th Century photographic printing of hand coated papers. During the semester students will work with carbon printing, argyrotypes, and palladium/platinum processes. \$45.00 Materials Fee - Payable at Registration. (CSU)

PHOT 223 C Alternative Photo Processes IV 3 Units*Prerequisite: PHOT 222 C.*

Term hours: 36 lecture and 72 laboratory TBA. This class will continue to investigate the artistic aspects and technical procedures used in 19th Century photographic printing of hand coated papers. During the semester students will work with photo gravure and multi-process projects. \$45.00 Materials Fee - Payable at Registration. (CSU)

PHOT 227 C Retouching and Digital Workflow 3 Units*Advisory: PHOT 103 C and PHOT 215 C.*

Term hours: 36 lecture and 72 laboratory TBA. This workflow based class will provide a foundation for capturing and processing RAW digital photo files with the latest prevailing high end digital imaging hardware and software. The course will be centered around using software such as Adobe Light room to create optimal digital files. Students will have the opportunity to gain hands on experience with various high end professional camera platforms. They will develop the skills necessary to work effectively with their own digital files as a professional photographer or in a support capacity such as a digital photo technician. \$45.00 Material Fee - Payable at Registration. (CSU)

PHOT 230 C Advanced Retouching and Digital Workflow 3 Units*Advisory: PHOT 227 C.*

Term hours: 36 lecture and 72 laboratory TBA. This course will allow students to work hands on with 35mm and 2 1/4 digital camera systems, building upon the skills learned in Digital Camera Workflow Class. Practical application of tethered photography using appropriate software. Students will have the opportunity to gain organizational skills such as file naming, shot folder hierarchy and metadata strategies. Monitor and camera calibration as well as basic computer and camera troubleshooting techniques will be taught. Through guest speakers and a set visit, they will gain valuable insights about how to work professionally as a photographer or digital tech. \$45.00 Material Fee - Payable at Registration. (CSU)

PHOT 235 C Drone Photography and Video 3 Units*Prerequisite: PHOT 101 C with a minimum grade of "C" and PHOT 103 C.*

Term hours: 36 lecture and 72 laboratory. This course is designed to give the student the ability to photograph both stills and videos from UAV's (drones). Special emphasis is placed on equipment selection, aerial photography skills, business opportunities, image editing and safety considerations. \$35.00 Material Fee - Payable at Registration (CSU)

PHOT 236 C UAV Flight Lab-Photography 2 Units*Prerequisite: PHOT 235 C with a minimum grade of "C".*

Term hours: 18 lecture and 54 laboratory. Students will receive instruction and participate in hands-on flight activities to develop, practice and optimize unmanned Aircraft System flight and photography skills. High end photo equipment and drones will be used. \$35.00 Material Fee - Payable at Registration (CSU)

PHOT 298 C Photography Seminar .5 to 12 Units*Prerequisite: May be required.**Corequisite: May be required.**Advisory: May be required.*

Term hours: 0-216 lecture and 0-1080 laboratory depending on units attempted. This is a course for students who wish to increase their knowledge of photography. Various topics will be offered. Unit credit may range from 1/2 to 12 units in any given semester. Consult the class schedule to verify credit for a particular semester. May be taken for credit 1-4 times. Pass/No Pass or Pass/No Pass/Letter Grade Option or Standard Letter Grade. Fees may be required-Payable at Registration. (CSU)

PHOT 299 C Independent Study .5 to 2 Units*Prerequisite: PHOT 103 C with a minimum grade of "C" and an Independent Study Learning Contract.*

Term hours: 9-36 lecture. This is a course that is designed for the student to increase their knowledge of a particular art discipline. Unit credit may range from 1/2 to 2 units in any given semester. (UC Credit Limitation/CSU)

**Physical Education —
Please see Kinesiology**

Physical Science

Division of Science/Engineering/Mathematics

Division Dean — Richard Fee

Faculty

Ron Armale
Victoria Castle
Kirk Domke
Michael Frey
Massoud Saleh
Brinda Subramaniam

Counselor

Deidre Porter

Physical Science (PHSC)

PHSC 104 C Physical Science for Teachers 4 Units

Same as CHEM 104 C

Prerequisite: MATH 020 C or MATH 041 C with a minimum grade of “C”.

Term hours: 54 lecture and 54 laboratory. This activity-based course provides an introduction to the basic concepts of physical science with emphasis on their practical importance and application in the real world. Topics include global warming, the automobile, health, and energy. This course is intended for students who want to become primary school teachers. Duplicate credit not granted for CHEM 104 C. (CSU, AA GE, CSU GE, C-ID: CHEM 140, C-ID: PHYS 140)

PHSC 196 C Field Studies in Physical Science 2 Units

Term hours: 18 lecture and 54 laboratory. This course involves lecture and field study in the physical sciences. During a given semester, multiple sections may be offered to different study areas or for different selected topics. Study areas include, but are not limited to, star gazing in the Santa Ana mountains or Anza area; viewing museums, planetarium, observatories; or listening to lectures. Field trips are required. (CSU)

PHSC 298 C Physical Science Seminar .5 to 12 Units

Prerequisite: May be required.

Corequisite: May be required.

Advisory: May be required.

Term hours: 0-216 lecture and/or 0-648 laboratory depending on units attempted. This course is for students who wish to increase their knowledge in various fields in the physical sciences. Various topics may be offered, such as the metric system of measurement, observational astronomy, etc., according to the interests of the instructor and students as stated in the class schedule. Consult the class schedule to verify unit credit and topics for a particular semester. Fees may be required—Payable at Registration. Pass/No Pass or Pass/No Pass/Letter Grade Option or Standard Letter Grade. (UC Credit Limitation/CSU)

PHSC 299 C Physical Sciences Independent Study .5 to 2 Units

Prerequisite: Approved Independent Study Learning Contract.

Term hours: 48-54 laboratory or project research for maximum credit. This course is for able students who have demonstrated interest and capability for increased knowledge of physical science through individual study, small group discussion conferences, or special laboratory project work. Independent laboratory or field study projects with staff supervision may be approved with written reports required. May be taken for credit 4 times. (UC Credit Limitation/CSU)

Physics

Division of Science/Engineering/Mathematics

Division Dean — Richard Fee

Faculty

Ron Armale
Brinda Subramaniam

Counselor

Deidre Porter

PROGRAM LEARNING OUTCOMES (PLOs)

The courses taught by this department contribute to the General Education and Basic Skills Program Learning Outcomes. Please refer to General Education and Basic Skills Program Learning Outcomes.

ASSOCIATE IN SCIENCE IN PHYSICS FOR TRANSFER DEGREE (AS-T)

Program Code: 1S31868

This curriculum is designed to provide an opportunity for the Physics major to achieve an Associate in Science Degree in Physics for Transfer (AS-T in Physics) which completes the first and second year requirements for transfer to a four-year public California institution. This degree provides valuable quantitative and problem-solving skills that are in demand by employers hiring, e.g., lab technicians, or in a variety of fields such as manufacturing and education. Of people who obtain a terminal bachelor's degree in physics, about half work in industry, in fields such as aerospace, military, software, and electronics. Most of the other half work either as high school teachers or as lab technicians at universities or government-funded laboratories. PhD's in physics are qualified for teaching at the university level and for scientific research, as well as for higher-level jobs in the same areas as those with bachelor's degrees. While at least a baccalaureate degree is recommended preparation for those considering professional careers, completion of this curriculum will demonstrate commitment to the field and provide comprehensive preparation for further academic study through upper-division course work. This curriculum specifically prepares the prospective transfer student for upper division course work in Physics or a similar major at a California State University (CSU) campus. Students should consult a counselor, the Transfer Center and the catalog of the transfer college or university to plan a specific program of study to meet the college or university's requirements.

Note: Courses that fulfill major requirements for an Associate Degree for Transfer at Cypress College might not be the same as those required for completing the major at all transfer institutions offering a Baccalaureate Degree. The Student Transfer Achievement Reform Act (Senate Bill 1440, now codified in California Education Code sections 66746–66749) guarantees admission to a California State University (CSU) campus for any community college student who completes an “associate degree for transfer,” a newly established variation of the associate degrees traditionally offered at a California community college. The AS-T is intended for students who plan to complete a bachelor's degree in a similar major at a CSU campus. Students completing these degrees (AS-T) are guaranteed admission to the CSU system, but not to a particular campus or major. Students transferring to a CSU campus that does accept the AS-T will be required to complete no more than 60 units after transfer to earn a bachelor's degree (unless the major is

designated “high-unit” major). This degree may not be the best option for students intending to transfer to a particular CSU campus or to a university or college that is not part of the CSU system. Students should consult with a counselor when planning to complete the degree for more information on university admission and transfer requirements. The completion of this curriculum will demonstrate commitment to the Physics field and provide comprehensive preparation for upper-division work.

To earn an AS-T in Physics students must complete the following requirements: (1) a minimum of 24 semester units or 36 quarter units in the Physics major with a minimum grade of “C”; (2) California State University General Education Breadth requirements (CSU GE Breadth) or the Intersegmental General Education Transfer Curriculum (CSU IGEC); (3) completion of 60 semester or 90 quarter units of CSU transferable course work; and (4) have an overall GPA of 2.0.

| Required Courses: (24 units) | | Units |
|------------------------------|------------------------|-----------|
| PHYS 221 C | General Physics I | 4 |
| PHYS 222 C | General Physics II | 4 |
| PHYS 223 C | General Physics III | 4 |
| MATH 150AC | Calculus I | 4 |
| MATH 150BC | Calculus II | 4 |
| MATH 250AC | Multivariable Calculus | 4 |
| Total Units Required | | 24 |

PHYSICS TRANSFER PROGRAM

Students should consult a counselor or www.assist.org for lower division major requirements for most California public universities. (See the Standard Definitions section of the catalog for a description of ASSIST.) Students transferring to an independent college/university should consult the catalog of the individual school and a counselor for lower division major requirements.

Physics (PHYS)

PHYS 130 C Elementary Physics 4 Units

Prerequisite: MATH 020 C or MATH 041 C with grades of “C” or better.

Term hours: 54 lecture and 54 laboratory. This is an entry level physics course for all science majors. The course provides an introduction to the basic concepts and laws of physics with emphasis upon their practical importance in everyday life. Laboratory work includes experiments in mechanics, heat, sound, electricity, and optics. This is a general education course in the physical science area. The course is not open for credit to students with previous college physics credit. No UC credit if taken after PHYS 201 C or PHYS 221 C. (UC Credit Limitation/CSU, AA GE, CSU GE, IGEC)

PHYS 201 C College Physics I 4 Units

Prerequisite: MATH 142 C and PHYS 130 C, with grades of “C” or better.

Term hours: 54 lecture and 54 laboratory. This is the first half of an algebra based two-semester physics sequence (PHYS 201 C and PHYS 202 C) designed primarily for students planning to major in life sciences, medical/dental fields, architecture, psychology, and similar professional fields. The course covers Newtonian mechanics, conservation laws, rotational dynamics, properties of matter, heat, and waves. The laboratory portion of the course investigates these topics both qualitatively and quantitatively, and includes the use of graphing, statistics, and propagation of errors. This course satisfies a requirement for biology majors in the CSU system, but not the UC system. (UC Credit Limitation/CSU, AA GE, CSU GE, IGEC, C-ID: PHYS 105)

PHYS 202 C College Physics II 4 Units

Prerequisite: PHYS 201 C, with a grade of “C” or better.

Term hours: 54 lecture and 54 laboratory. This is the second half of an algebra-based two-semester sequence (PHYS 201 C and 202 C) designed primarily for students planning to major in life sciences, medical/dental fields, architecture, psychology, and similar professional fields. This course covers electricity and magnetism, optics, atomic physics, nuclear physics, and special theory of relativity. The laboratory portion of the course investigates these topics both qualitatively and quantitatively, and includes the use of graphing, statistics, and propagation of errors. This course satisfies a requirement for biology majors in the CSU system but not the UC system. (UC Credit Limitation/CSU, CSU GE, IGEC, C-ID: PHYS 110)

PHYS 210 C Physics for Life Sciences I 4 Units

Prerequisite: PHYS 130 C or High School Physics and MATH 150AC, with a grade of “C” or better, or concurrent enrollment in MATH 150AC.

Term hours: 54 lecture and 54 laboratory. This is the first half of a calculus-based two-semester sequence (PHYS 210 C and 211 C) designed for students majoring in the life sciences. This course covers Newtonian mechanics, conservation laws, rotational dynamics, properties of matter, heat and waves. The laboratory portion of the course investigates these topics both qualitatively and quantitatively, and includes the use of graphing, statistics, and propagation of errors. This course satisfies a requirement for biology majors in the UC system; the CSU system will accept either this sequence or PHYS 201 C and 202 C sequence. (UC Credit Limitation/CSU, AA GE, CSU GE, IGEC)

PHYS 211 C Physics for Life Sciences II 4 Units

Prerequisite: PHYS 210 C with a grade of “C” or better and completion of or concurrent enrollment in MATH 150BC.

Term hours: 54 lecture and 54 laboratory. This is the second half of a calculus-based two-semester sequence (PHYS 210 C and 211 C) designed for students majoring in the life sciences. This course covers electricity, magnetism, optics, special relativity, and modern physics. The laboratory portion of the course investigates these topics both qualitatively and quantitatively, and includes the use of graphing, statistics, and propagation of errors. This course satisfies a requirement for biology majors in the UC system; the CSU system will accept either this sequence or PHYS 201 C and 202 C sequence. (UC Credit Limitation/CSU, AA GE, CSU GE, IGEC)

PHYS 221 C General Physics I 4 Units

Prerequisite: PHYS 130 C with a minimum grade of “C” (or high school physics with a minimum grade of “B”) and MATH 150AC, with a minimum grade of “C”; and completion of or concurrent enrollment in MATH 150BC.

Term hours: 54 lecture and 54 laboratory. This is the first course of a three-semester introductory physics program for students majoring in physics, chemistry, geology, engineering (all areas), computer science, mathematics and other related fields. Topics studied include mechanics, oscillations, properties of matter, and fluids. Problems and derivations require knowledge of differential and integral calculus. (UC Credit Limitation/CSU, AA GE, CSU GE, IGEC, C-ID: PHYS 205)

PHYS 222 C General Physics II 4 Units

Prerequisite: MATH 150BC and PHYS 221 C, with grades of “C” or better.

Advisory: MATH 250AC.

Term hours: 54 lecture and 54 laboratory. This course is part of a three-semester program of introductory calculus based physics for students majoring in physics, chemistry, geology, engineering (all specializations), computer science, mathematics and other related fields. Topics covered are basic laws of electricity and magnetism including electrostatics, current, magnetic fields, electromagnetic induction, DC circuits, AC circuits, and electromagnetic waves. Requires knowledge of differential and integral calculus. (UC Credit Limitation/CSU, CSU GE, IGEC, C-ID: PHYS 210)

PHYS 223 C General Physics III**4 Units***Prerequisite: PHYS 221 C, and MATH 150BC, with grades of "C" or better.**Advisory: MATH 250AC.*

Term hours: 54 lecture and 54 laboratory. This course is part of a three-semester program of introductory calculus based physics for students majoring in physics, chemistry, geology, engineering (all areas), mathematics, and other related fields. It may be taken before or after PHYS 222 C. Topics covered include fluid mechanics, oscillations and waves, thermodynamics and kinetic theory, geometrical and physical optics, special theory of relativity, introduction to quantum mechanics, atomic physics, and nuclear physics. Requires knowledge of differential and integral calculus. (UC Credit Limitation/CSU, CSU GE, IGETC, C-ID: PHYS 215)

Political Science

Division of Social Sciences

Division Dean — Lisa Gaetje, Interim*Faculty*

Gloria Badal

Eapen Peter Mathews

Counselors

Therese Mosqueda-Ponce

Daniel Pelletier

PROGRAM LEARNING OUTCOMES (PLOs)

The courses taught by this department contribute to the General Education and Basic Skills Program Learning Outcomes. Please refer to General Education and Basic Skills Program Learning Outcomes.

ASSOCIATE IN ARTS IN POLITICAL SCIENCE FOR TRANSFER DEGREE (AA-T)

Program Code: 1A32251

This curriculum is designed to provide an opportunity for the Political Science major to achieve an Associate in Arts Degree in Political Science for Transfer (AA-T in Political Science) which completes the first and second year requirements for transfer to a four-year public California institution. While at least a baccalaureate degree is recommended preparation for those considering professional careers, completion of this curriculum will demonstrate commitment to the field and provide comprehensive preparation for further academic study through upper-division course work. This curriculum specifically prepares the prospective transfer student for upper division course work in Political Science or a similar major at a California State University (CSU) campus. Students should consult a counselor, the Transfer Center and the catalog of the transfer college or university to plan a specific program of study to meet the college or university's requirements.

Note: Courses that fulfill major requirements for an Associate Degree for Transfer at Cypress College might not be the same as those required for completing the major at all transfer institutions offering a Baccalaureate Degree. The Student Transfer Achievement Reform Act (Senate Bill 1440, now codified in California Education Code sections 66746–66749) guarantees admission to a California State University (CSU) campus for any community college student who completes an "associate degree for transfer," a newly established variation of the associate degrees traditionally offered at a California community college.

The AA-T is intended for students who plan to complete a bachelor's degree in a similar major at a CSU campus. Students completing these degrees (AA-T) are guaranteed admission to the CSU system, but not to a particular campus or major. Students transferring to a CSU campus that does accept the AA-T will be required to complete no more than 60 units after transfer to earn a bachelor's degree (unless the major is designated "high-unit" major). This degree may not be the best option for students intending to transfer to a particular CSU campus or to a university or college that is not part of the CSU system. Students should consult with a counselor when planning to complete the degree for more information on university admission and transfer requirements.

Students successfully completing the AA-T in Political Science will acquire a fundamental knowledge base of Political Science, introducing students to concepts, methods, and knowledge that help them understand and judge politics within and among nations, and possess a basic understanding of areas that have an interdisciplinary association to Political Science. This degree will provide students with an introduction to the field including its applied areas. The intent is to prepare students for further academic study in the field. It will also demonstrate commitment to the field and provide comprehensive preparation for upper division work at the university level. At the baccalaureate level students can continue an education in various areas of Political Science including the following four subfields: Political Theory, American Politics, Comparative Politics, or International Relations. Graduate study is important in Political Science. Those holding a Master's or Doctoral degree may find employment in teaching, business, government, journalism, education, or nonprofit organizations; or it can lead to a PhD program in the social sciences or to professional school in law, business, public policy, or international relations. Those without a graduate degree will find limited career opportunity in direct areas of Political Science.

To earn an AA-T in Political Science students must complete the following requirements: (1) a minimum of 19 semester units or 29 quarter units in the Political Science major with a minimum grade of "C"; (2) California State University General Education Breadth requirements (CSU GE Breadth) or the Intersegmental General Education Transfer Curriculum (CSU IGETC); (3) completion of 60 semester or 90 quarter units of CSU transferable course work; and (4) have an overall GPA of 2.0.

| Required Core: 3 units | | Units |
|--|--|--------------|
| POSC 100 C | United States Government | 3 |
| | or | |
| POSC 100HC | Honors United States Government | (3) |
| List A: Select 2 courses from the following: (10 units total) | | Units |
| POSC 120 C | Political Theory | 3 |
| POSC 200 C | Introduction to Political Science | 3 |
| POSC 215 C | Comparative Politics | 3 |
| POSC 230 C | International Relations | 3 |
| | and | |
| Any one of the following: | | Units |
| MATH 120 C | Introduction to Probability and Statistics | 4 |
| PSY 161 C | Probability and Statistics — Social Sciences | 4 |
| | or | |
| PSY 161HC | Honors Probability and Statistics — Social Sciences | (4) |
| SOC 161 C | Probability and Statistics — Social Sciences | 4 |
| | or | |
| SOC 161HC | Honors Probability and Statistics — Social Sciences | (4) |

**List B: Select 2 courses (6 units) from the following:
(or any Political Science courses not already used from List A)**

| | | Units |
|-----------------------------|--|--------------|
| ECON 100 C | Principles of Economics — Macro or | 3 |
| ECON 100HC | Honors Principles of Economics | (3) |
| ECON 105 C | Principles of Economics — Micro or | 3 |
| ECON 105HC | Honors Principles of Economics | (3) |
| ECON 110 C | Survey of Economics | 3 |
| ETHS 101 C | American Ethnic Studies or | 3 |
| ETHS 101HC | Honors American Ethnic Studies | (3) |
| ETHS 129 C | Introduction to African-American Studies | 3 |
| ETHS 150 C | Introduction to Chicana/o Studies | 3 |
| ETHS 160 C | Native American History | 3 |
| ETHS 170 C | Introduction to Asian Pacific American Studies | 3 |
| GEOG 100 C | World Geography or | 3 |
| GEOG 100HC | Honors World Geography | (3) |
| HIST 110 C | Western Civilizations I or | 3 |
| HIST 110HC | Honors Western Civilizations I | (3) |
| HIST 112 C | World Civilizations I or | 3 |
| HIST 112HC | Honors World Civilizations I | (3) |
| HIST 142 C | History of Latin America I | 3 |
| HIST 151 C | Survey of British History I | 3 |
| HIST 160 C | Asian Civilizations I | 3 |
| HIST 170 C | History of the United States I or | 3 |
| HIST 170HC | Honors History of the United States I | (3) |
| HIST 171 C | History of the United States II or | 3 |
| HIST 171HC | Honors History of the United States II | (3) |
| PSY 101 C | Introduction to Psychology or | 3 |
| PSY 101HC | Honors Introduction to Psychology | (3) |
| POSC 101 C | Gender and American Politics | 3 |
| POSC 209 C | Urban Politics | 3 |
| POSC 210 C | Contemporary Political Issues | 3 |
| POSC 216 C | Politics of the Middle East | 3 |
| SOC 101 C | Introduction to Sociology or | 3 |
| SOC 101HC | Honors Introduction to Sociology | (3) |
| SOC 292 C | Introduction to Criminology or | 3 |
| HUSR 292 C | Introduction to Criminology | (3) |
| Total Units Required | | 19 |

POLITICAL SCIENCE TRANSFER PROGRAM

Students should consult a counselor or www.assist.org for lower division major requirements for most California public universities. (See the Standard Definitions section of the catalog for a description of ASSIST.) Students transferring to an independent college/university should consult the catalog of the individual school and a counselor for lower division major requirements.

Political Science (POSC)

POSC 100 C United States Government 3 Units

Advisory: Eligibility for ENGL 100 C.

Term hours: 54 lecture. This course covers the political theories and practices of United States Government at national, state and local levels. Duplicate credit not granted for POSC 100HC. Credit by Examination. (UC Credit Limitation/CSU, AA GE, CSU GE, IGETC, C-ID: POLS 110)

POSC 100HC Honors United States Government 3 Units

Advisory: Eligibility for ENGL 100 C.

Term hours: 54 lecture. This course is an enhanced college level course enhanced for honors students. It covers the political theories and practices of the United States Government at national, state and local level. Duplicate credit not granted for POSC 100 C. (UC Credit Limitation/CSU, AA GE, CSU GE, IGETC, C-ID: POLS 110)

POSC 101 C Gender and American Politics 3 Units

Advisory: Eligibility for ENGL 100 C.

Term hours: 54 lecture. This course is an introduction to the study of American politics at the national, state, and local levels with an emphasis on the role of gender. It examines women’s participation in American politics from the perspective of race, class, and ethnicity. Contemporary political analysis will focus on women’s political agenda from the 1960’s to the 21st century, centering around issues such as equal pay, sex discrimination in education and the work place, affirmative action, reproductive rights, sexual choice, domestic violence, and increasing the representation of women in local and national political arenas. (UC/CSU, AA GE, CSU GE, IGETC)

POSC 120 C Political Theory 3 Units

Advisory: Eligibility for ENGL 100 C.

Term hours: 54 lecture. This course is a survey of Western political theory from ancient Greece to the Modern Age. It shows how political theory shapes current institutions and ideologies in the United States, Europe, and other countries around the world. (UC/CSU, AA GE, CSU GE, IGETC, C-ID: POLS 120)

POSC 135 C Campaigns, Parties and Elections 3 Units

Advisory: Eligibility for ENGL 100 C.

Term hours: 54 lecture. This course is an analysis of the challenges faced by the Democratic and Republican parties as they are being replaced by campaign management firms (CMF’s), Political Action Committees (PAC’s) and electronic media advertising. Special emphasis is given to critical analysis of the presidential election campaign process, and of the resulting implications of the democratic process in the United States. (CSU)

POSC 200 C Introduction to Political Science 3 Units

Advisory: Eligibility for ENGL 100 C.

Term hours: 54 lecture. This course is an introduction to the study of political science. It explores the many aspects of politics, examining its relationship to morality, culture, economics, justice and international affairs both theoretically and practically. As an introductory course, it includes elements from the major sub-disciplines of political science, including American politics, comparative politics, and international relations. (UC/CSU, AA GE, CSU GE, IGETC, C-ID: POLS 150)

POSC 209 C Urban Politics 3 Units

Advisory: Eligibility for ENGL 100 C.

Term hours: 54 lecture. This course is a concentrated study of urban America with particular emphasis on the challenging problems facing the country’s metropolitan areas. The approach will be interdisciplinary in order to facilitate conceptual learning and a balanced understanding of the urban dilemma. Major areas of study will include the history and development of urban United States intergovernmental relations, poverty, racial and ethnic relations, pollution, crime, public services, education, planning and renewal. (UC/CSU, CSU GE, IGETC, CUL DIV)

POSC 210 C Contemporary Political Issues 3 Units*Advisory: Eligibility for ENGL 100 C.*

Term hours: 54 lecture. This course is an intensive study of contemporary issues associated with the concepts of democracy, federalism, separation of powers, judicial review, preservation of individual rights and related topics. (UC/CSU, AA GE, CSU GE, IGETC)

POSC 215 C Comparative Politics 3 Units*Advisory: Eligibility for ENGL 100 C.*

Term hours: 54 lecture. This course is a comparative study of the political theories and practices of selected European and non-Western political systems. Also included in the course is a careful analysis of the dynamics of political change and its relationship to economic and social development. (UC/CSU, AA GE, CSU GE, IGETC, C-ID: POLS 130)

POSC 216 C Politics of the Middle East 3 Units*Advisory: Eligibility for ENGL 100 C.*

Term hours: 54 lecture. This course is an introduction to the political, social, economic and ideological foundations of Middle East in general and major states in the region in particular. Emphasis is placed on the political and economic developments in Egypt, Iraq, Iran, Israel, and Saudi Arabia. Topics covered include: introduction to the land, peoples, cultures, and religions; colonialism and the emergence of modern states following World War I; Western influence and Islamic revivalism; regional conflicts (Arab-Israeli, Iran-Iraq, Gulf Wars); and politics and economics of it; U.S. based ethnic interest groups and their influence on U.S. foreign policy; patrimonialism and militarism; liberalization and democratization. (UC/CSU, AA GE, CSU GE, IGETC)

POSC 230 C International Relations 3 Units*Advisory: Eligibility for ENGL 100 C.*

Term hours: 54 lecture. This course is a study of relations of nations including the function of power, diplomacy, international law and organizations, and economic factors. Special emphasis will be placed on such concepts as war, nationalism, imperialism, ideological conflict and collective security, and how these concepts affect American foreign policy. (UC/CSU, AA GE, CSU GE, IGETC, C-ID: POLS 140)

POSC 298 C Political Science Seminar .5 to 12 Units*Prerequisite: May be required.**Corequisite: May be required.**Advisory: May be required.*

Term hours: 0-216 lecture and/or 0-432 laboratory depending on units attempted. This is a lecture/discussion type course developed on a particular limited problem or topic of interest to students. It is designed for able students who wish to increase their knowledge of a particular topic concerning which no other regular class is offered. A paper or group activity may be requested. Credit may range from 1/2 unit to 12 units. Consult class schedule for the offerings a particular semester. May be taken for credit 1-4 times. Pass/No Pass or Pass/No Pass/Letter Grade Option or Standard Letter Grade. Fees may be required—Payable at Registration. (UC Credit Limitation/CSU)

POSC 299 C Political Science Independent Study 1 Unit*Prerequisite: Approved Independent Study Learning Contract.*

May be taken for credit 4 times.

Varying hours of scheduled conferences per week according to instructor. Independent study is for able students who wish to extend their knowledge of a particular area through individual research and study. It is thought that topics might develop out of a curiosity stimulated in a regular class. The student would then contact the supervising instructor to develop a contract for his/her particular interest so that they could learn more regarding their special topic. (UC Credit Limitation/CSU)

Portuguese

Division of Language Arts

Division Dean — Eldon Young*Faculty*

Vacant

Counselors

Daniel Pelletier

Therese Mosqueda-Ponce

PROGRAM LEARNING OUTCOMES (PLOs)

The courses taught by this department contribute to the General Education and Basic Skills Program Learning Outcomes. Please refer to General Education and Basic Skills Program Learning Outcomes.

Portuguese (PORT)

PORT 101 C Elementary Portuguese I 5 Units

Term hours: 90 lecture. The course focuses on the four major skills of language learning—listening comprehension, speaking, reading, and writing—and the grammar and vocabulary necessary to acquire these skills. Included is an introduction to customs, culture, and civilization of Brazil, Portugal and other Portuguese-speaking countries. This course is conducted primarily in Brazilian Portuguese. Pass/No Pass/Letter Grade Option. (UC/CSU, AA GE, CSU GE)

PORT 102 C Elementary Portuguese II 5 Units*Prerequisite: PORT 101 C Elementary Portuguese I with a grade of “C” or better or one year of high school Portuguese with a grade of “C” or better.*

Term hours: 90 lecture. This course continues to emphasize the acquisition of basic skills in pronunciation, listening, speaking, reading, and writing. Students will increase their knowledge of the culture, history, and geography of Portuguese speaking countries through lectures, slides, films, and reading and writing assignments. Pass/No Pass/Letter Grade Option. (UC/CSU, AA GE, CSU GE, IGETC)

Pre-Professional Programs

Dentistry

Medicine

Optometry

Pharmacy

Physician Assistant

Physical Therapy

Veterinary Medicine

Professional programs such as dentistry, medicine, pharmacy, optometry, physician assistant, physical therapy and veterinary medicine are most often graduate programs that require a bachelor degree or significant preparation prior to entering the program. The appropriate preparation varies according to the school and specific program. Students are advised to meet with a counselor to discuss options for their bachelor degree and the lower division requirements for the program and school of their choice.

Psychiatric Technology

Division of Health Science

Division Dean — Rebecca Gomez, Interim

Faculty

Jane Boyce

Joseph Franks

Christina Johannsen

Marcus Marquardt

Jaime Ramos

Counselors

Kelly Carter

Denise Vo

Doreen Villaseñor

PROGRAM LEARNING OUTCOMES (PLOs)

Psychiatric Technology

A student who completes the Psychiatric Technology program will be able to:

1. Show effective communication with the patient/client, family, health care team, and community.
2. Identify and prioritize nursing diagnoses through assessment/observation of the patient/client's physical condition, behavior and through interpretation/analysis of information obtained from the patient, client record and others, including members of the health care team.

3. Create a plan of care in collaboration with the patient/client which ensures that direct and indirect nursing, psychiatric care and habilitation training provided for the patient/client's safety, comfort, hygiene, and protection, as well as disease prevention, health promotion, and restorative measures.
4. Perform skills essential to implement safe and effective care to individuals with nursing needs, psychiatric disorders and/or developmental disabilities that involve explaining health treatment, and teaching patient/client and family how to meet his or her health care needs.
5. Evaluate the expected outcomes of the plan of care through observation of the client's physical condition, behavior, signs and symptoms of illness, reactions to treatment, and through communication with the patient/client and the health care team members; modifies/progresses plan as needed.
6. Advocate for the patient/client by initiating action to improve health care and to make informed decisions.
7. Practice according to ethical and legal professional standards as set forth by the Cypress College Psychiatric Technician program and the California Board of Vocational Nursing and Psychiatric Technicians.
8. Evaluate personal strengths and growth needs and incorporate these into a plan for professional development.

PROGRAM OBJECTIVES

This program aims to prepare a student to meet the requirements for licensure as a Psychiatric Technician in the state of California. A Psychiatric Technician is a licensed member of the professional health-care services team working with people who are emotionally or developmentally disabled. Employed by private and state mental hospitals, developmental centers, and many community facilities. Psychiatric Technicians will also find a variety of jobs available in the fields of prisons/corrections and human services. These include substance abuse programs, forensic facilities, special education and many other areas promoting mental health. There are career advancement opportunities available in the areas of counseling, education, nursing, and vendorization of services.

The program is *accredited* by, and *conforms* to, the regulations of the California Board of Vocational Nursing and Psychiatric Technicians. Upon successful completion of the program, graduates are eligible to take the State Board Licensure Examination.

MINIMUM STANDARDS FOR APPLICANTS

1. Graduation from high school or completion of the General Education Development (GED) test with an average score of 450 on the five-test battery or passing the high school proficiency examination. Possession of an associate or higher degree satisfies this requirement.
2. Completion of ENGL 058 C/ESL 185 C or a comparable course with a grade of "C" or better, or submission of test scores that indicate eligibility for ENGL 060 C/ESL 186 C.
3. Completion of BIOL 160 C and PSY 101 C with a "C" or better or transcript showing courses in progress.

APPLICATION PROCEDURES

1. Meet with a counselor to determine fulfillment of the minimum standards.
2. Applications must be completed **online**. Please see the **Health Science Application link** on the Psychiatric Technology home page.
3. Submit supporting documentation with the signature page of application. This includes a copy of high school diploma, GED or high school proficiency and **official** college transcripts.

SELECTION CRITERIA

1. Twenty-four (24) students are selected for admission each Fall and Spring semester. The number of applicants usually exceeds available seats.
2. Selection is based on completion of required prerequisites and date of application.
3. Selection criteria is subject to change. See a Health Science Counselor for current selection criteria.
4. Upon selection for the program but prior to the start of classes, the candidate will be required to obtain a physical examination and required immunizations.
5. Students selected for admission to the program must obtain a Health Care Provider level cardiopulmonary resuscitation (CPR) card prior to attending clinical training and must maintain current certification throughout the program.
6. If you have been convicted of a criminal offense, your eligibility to enroll in the program may be affected. All students will be fingerprinted and cleared by the FBI and Department of Justice (DOJ) before enrolling in PT 110 C.

ASSOCIATE IN SCIENCE DEGREE

PSYCHIATRIC TECHNOLOGY Program Code: 1S03790

While the state of California does not require an Associate Degree for licensure as a Psychiatric Technician, the student may elect to earn one. To receive an Associate in Science Degree, the student must complete all Psychiatric Technician course requirements with a minimum grade of "C." At least 50% of the Psychiatric Technician course requirements must be completed at Cypress College. A minimum of 19 additional General Education/Graduation Requirements must be earned with an overall GPA of 2.0.

To earn an Associate Degree students must complete: (1) all major course requirements with a minimum grade of "C"; (2) 25 units of General Education Graduation Requirements; (3) the cultural diversity and reading requirements; (4) any elective courses to complete a minimum of 60 units; and, (5) have a minimum GPA of 2.0. At least 50% of all major course work must be completed at Cypress College.

Required courses are listed in suggested sequence:

Note: A current "C" cardiopulmonary resuscitation (CPR) certification must be maintained by all students admitted to the program.

Prerequisite Courses: ENGL 060 C, PSY 101 C, BIO 160 C and Completion of PSY 139 C prior to program completion.

| | Units |
|-------------------|-------|
| BIOL 160 C* | 3 |
| PSY 101 C* | 3 |
| SEMESTER 1 | |
| PT 110 C | 7 |
| PT 115 C | 7 |
| PSY 139 C* | 3 |

| | Units |
|-----------------------------|-------------------------------|
| PT 120 C | 7 |
| PT 125 C | 7 |
| SEMESTER 2 | |
| | Developmental Disabilities I |
| | Developmental Disabilities II |
| SEMESTER 3 | |
| PT 130 C | 7 |
| PT 135 C | 7 |
| PT 090 C | 0.5 |
| Total Units Required | 51.5 |

*Courses may be taken without official acceptance into the program. All other required courses must be taken after official acceptance.

All general education units may be taken prior to enrollment in the program or at the completion of the course work required by the BVNPT for licensure eligibility.

PSYCHIATRIC TECHNOLOGY CERTIFICATE

Program Code: 1C21116

This program aims to prepare a student to meet the requirements for licensure as a Psychiatric Technician in the state of California. A Psychiatric Technician is a licensed member of the professional services team working with people who are intellectually or mentally disabled. Historically employed by private and state hospitals, developmental centers, and many community mental health facilities, Psychiatric Technicians will increasingly find a variety of jobs available in the fields of corrections and human services. These include day care centers, substance abuse programs, forensic facilities, special education and many other areas promoting intellectual, developmental and mental health.

The program is accredited by and conforms to the regulations of the California Board of Vocational Nursing and Psychiatric Technicians (BVNPT). Upon successful completion of the program, graduates are eligible to take the State Board Licensure Examination.

To earn a certificate, complete the required courses with a minimum grade of "C." At least 50% of all course work must be completed at Cypress College. Upon completion of the 51 units of required course work, the student becomes eligible to apply to the BVNPT for licensure examination.

| Prerequisite Courses: | Units |
|-----------------------|----------------------------|
| BIOL 160 C | 3 |
| PSY 101 C | 3 |
| | Integrated Medical Science |
| | Introduction to Psychology |
| SEMESTER 1 | |
| PT 110 C | 7 |
| PT 115 C | 7 |
| PSY 139 C* | 3 |
| SEMESTER 2 | |
| PT 120 C | 7 |
| PT 125 C | 7 |
| SEMESTER 3 | |
| PT 130 C | 7 |
| PT 135 C | 7 |
| PT 090 C | 0.5 |
| Total Units | 51.5 |

*A score of 3 or higher on the Advanced Placement (AP) Psychology exam meets this requirement upon petition through Admissions and Records. See a counselor for more information.

Psychiatric Technology (PT)

PT 080 C Selected Topics/Psychiatric Technology 1 Unit

Term hours: 18 lecture. This course is designed to meet the health science student's need for current topics and issues, updated information in health care, review of specialized subject matter, and/or preparation for health related licensure and certification exams. Content will emphasize clinical application of theoretical principles in the discipline. Resource materials, instructor assessment of individual student knowledge and skills will be utilized. May be taken for credit 4 times. Pass/No Pass/Letter Grade Option.

PT 085 C Psychiatric Technician-Work Experience 1 to 4 Units

Prerequisite: Concurrent enrollment in Psychiatric Technician Program.

Term hours: 18 lecture and 80 hours (minimum) related employment. This course provides practical work experience for students caring for individuals with developmental disabilities in community settings. May be taken for credit 4 times. Pass/No Pass/Letter Grade Option.

PT 090 C Leadership Supervision and Ethics .5 Units

Prerequisite: PT 130 C with a minimum grade of "C".

Corequisite: Completion of or concurrent enrollment in PT 135 C.

Term hours: 9 lecture. This course defines the leadership and supervisory roles of the mental health professional with focus on the ethical considerations surrounding working with the intellectually disabled and mentally ill.

PT 110 C Nursing Science I 7 Units

Prerequisite: Acceptance into the Psychiatric Technology Program.

Term hours: 81 lecture and 135 laboratory. This course presents fundamental concepts and scientific principles of nursing care. It begins to prepare students for the safe administration of medications by introducing them to the modern systems of measurement. Principles discussed in lecture will be applied in the clinical setting. \$126.00 Material Fee-Payable at Registration. (CSU)

PT 115 C Nursing Science II 7 Units

Prerequisite: Completion of or concurrent enrollment in PT 110 C with a minimum grade of "C".

Term hours: 81 lecture and 135 laboratory. This course explores the disease process of medical/surgical conditions relative to etiology, pathology, and treatment modalities. The therapeutic use of medication, the principles of nutrition, and the application of the nursing process are presented in classroom instruction and implemented in clinical practice. (CSU)

PT 120 C Developmental Disabilities I 7 Units

Prerequisite: PT 115 C.

Term hours: 72 lecture and 162 laboratory. This course explores the theory and principles directly related to the delivery of care and services to persons with intellectual/developmental disabilities in the school setting and vocation education classroom setting in California. Students learn how to teach self-help and independent living skills to persons with intellectual/developmental disabilities. (CSU)

PT 125 C Developmental Disabilities II 7 Units

Prerequisite: PT 120 C.

Term hours: 54 lecture and 189 laboratory. This course focuses on the cause and treatment of behavioral disorders of the developmentally disabled. The theory and application of behavior assessment and intervention techniques is stressed. Behavioral assessment, teaching strategies, pharmacological interventions and special dietary needs are also covered. (CSU)

PT 130 C Mental Disabilities I 7 Units

Prerequisite: PT 125 C.

Term hours: 54 lecture and 189 laboratory. This course introduces the theory, psychological and mental health concepts of psychiatric nursing while exploring the causes and treatments of mental illness in chronically hospitalized and forensic individuals. Students are tasked with caring for the mentally disabled client at the tertiary level of intervention with emphasis placed on assessment, intervention and valid rationale for treatment of long term mental illness. Fee for CPR renewal and fingerprint fees not to exceed \$100. (CSU)

PT 135 C Mental Disabilities II 7 Units

Prerequisite: PT 130 C.

Term hours: 81 lecture and 162 laboratory. This course prepares the student to intervene at the primary and secondary levels of treatment in the care of individuals with mental disabilities. Primary interventions include prevention of mental disabilities through the education of individuals at risk, while secondary interventions are aimed at identified clients during periods of increased stress. (CSU)

Psychology

Division of Social Sciences

Division Dean — Lisa Gaetje, Interim

Faculty

Angela de Dios
Susan Johnson
Randall Martinez
Carlos Sandoval
Brandy Young

Counselors

Therese Mosqueda-Ponce
Daniel Pelletier

PROGRAM LEARNING OUTCOMES (PLOs)

The courses taught by this department contribute to the General Education and Basic Skills Program Learning Outcomes. Please refer to General Education and Basic Skills Program Learning Outcomes.

ASSOCIATE IN ARTS IN PSYCHOLOGY FOR TRANSFER DEGREE (AA-T) Program Code: 1A31353

This curriculum is designed to provide an opportunity for the Psychology major to achieve an Associate in Arts Degree in Psychology for Transfer (AA-T in Psychology) which completes the first and second year requirements for transfer to a four-year public California institution.

While at least a baccalaureate degree is recommended preparation for those considering professional careers, completion of this curriculum will demonstrate commitment to the field and provide comprehensive preparation for further academic study through upper-division course work. This curriculum specifically prepares the prospective transfer student for upper division course work in Psychology or a similar major at a California State University (CSU) campus. Students should consult a counselor, the Transfer Center and the catalog of the transfer-college or university to plan a specific program of study to meet the college or university's requirements.

Note: Courses that fulfill major requirements for an Associate Degree for Transfer at Cypress College might not be the same as those required for completing the major at all transfer institutions offering a Baccalaureate Degree.

The Student Transfer Achievement Reform Act (Senate Bill 1440, now codified in California Education Code sections 66746–66749) guarantees admission to a California State University (CSU) campus for any community college student who completes an “associate degree for transfer,” a newly established variation of the associate degrees traditionally offered at a California community college. The AA-T is intended for students who plan to complete a bachelor’s degree in a similar major at a CSU campus. Students completing these degrees (AA-T) are guaranteed admission to the CSU system, but not to a particular campus or major. Students transferring to a CSU campus that does accept the AA-T will be required to complete no more than 60 units after transfer to earn a bachelor’s degree (unless the major is designated a “high-unit” major). This degree may not be the best option for students intending to transfer to a particular CSU campus or to a university or college that is not part of the CSU system. Students should consult with a counselor when planning to complete the degree for more information on university admission and transfer requirements.

Students successfully completing the AA-T in Psychology will acquire a fundamental knowledge base of psychology, learn basic knowledge and skills in data analysis and research methods, and possess a basic understanding of areas that have an interdisciplinary association to Psychology. This degree will provide students with an introduction to the field including its scientific foundations and applied areas. The intent is to prepare students for further academic study in the field. It will also demonstrate commitment to the field and provide comprehensive preparation for upper division work at the university level. At the baccalaureate level students can continue an education in various areas of psychology including research methods, cognition, physiological psychology, development, environmental psychology, organizational psychology, clinical psychology, and educational psychology. Graduate study is important in Psychology. Those holding a Master’s or Doctoral degree may find employment in teaching, research, private practice, or welfare and health related fields. Those without a graduate degree will find limited career opportunity in direct areas of Psychology.

To earn an AA-T in Psychology students must complete the following requirements: (1) a minimum of 20–22 semester units or 30–33 quarter units in the Psychology major with a minimum grade of “C”; (2) California State University General Education Breadth requirements (CSU GE Breadth) or the Intersegmental General Education Transfer Curriculum (IGETC); (3) elective courses to complete a minimum of 60 units of CSU transferable course work; (4) have an overall GPA of 2.0.

| Required Core Courses: (11 units) | | Units |
|--|---|--------------|
| PSY 101 C | Introduction to Psychology | 3 |
| | or | |
| PSY 101HC | Honors Introduction to Psychology | (3) |
| PSY 161 C | Probability and Statistics — Social Sciences | 4 |
| | or | |
| PSY 161HC | Honors Probability and Statistics — Social Sciences | (4) |
| | or | |
| SOC 161 C | Probability and Statistics — Social Sciences | (4) |
| | or | |
| SOC 161HC | Honors Probability and Statistics — Social Sciences | (4) |
| PSY 202 C | Research Methods in Psychology | 4 |

| | | |
|--|---------------------------|--------------|
| List A: Select one course of three (3) to five (5) units. | | Units |
| PSY 221 C | The Brain and Behavior | 3 |
| BIOL 101 C | General Biology | 5 |
| | or | |
| BIOL 101HC | Honors General Biology | (5) |
| List B: Select one of the following three (3) unit courses, or any course not taken in List A (3–5 units) | | Units |
| PSY 139 C | Developmental Psychology | 3 |
| PSY 222 C | Abnormal Psychology | 3 |
| List C: Select one of the following as a three (3) unit Psychology course not selected in List A or List B or one of the following: | | Units |
| PSY 110 C | Applied Psychology | 3 |
| PSY 120 C | Human Sexuality | 3 |
| | or | |
| PSY 145 C | Child Psychology | 3 |
| PSY 131 C | Cross-Cultural Psychology | 3 |
| PSY 251 C | Social Psychology | 3 |
| PSY 255 C | Psychology of Aging | 3 |
| | or | |
| HUSR 255 C | Psychology of Aging | (3) |
| Total Units Required | | 20–22 |

PSYCHOLOGY TRANSFER PROGRAM

Students should consult a counselor or www.assist.org for lower division major requirements for most California public universities. (See the Standard Definitions section of the catalog for a description of ASSIST.) Students transferring to an independent college/university should consult the catalog of the individual school and a counselor for lower division major requirements.

Psychology (PSY)

PSY 101 C Introduction to Psychology **3 Units**

Advisory: Eligibility for ENGL 100 C.

Term hours: 54 lecture. This course is a scientific consideration of the psychological foundations of behavior. It will investigate psychological development, motivation, sensation, perception, learning, thinking, language, psychological measurement, and principles of mental illness and mental health. Duplicate credit not granted for PSY 101HC. (UC/CSU, AA GE, CSU GE, IGETC, C-ID: PSY 110)

PSY 101HC Honors Introduction to Psychology **3 Units**

Advisory: Eligibility for ENGL 100 C.

Term hours: 54 lecture. This course, enriched for honors students, is a scientific introduction to the major areas of psychology. These areas include research methodology, consciousness, cognition, memory, perception, sensation, motivation, emotion, learning, development, personality, abnormal psychology, and physiological psychology. Students will examine, demonstrate and critique principles, theories, and research on human cognition, emotion, behavior, and conscious experience. The course uses lecture, multimedia presentation, class discussion, online communication, simulations, online resources, and research projects to enhance the learning experience of students. Duplicate credit not granted for PSY 101 C. (UC/CSU, AA GE, CSU GE, IGETC, C-ID: PSY 110)

PSY 110 C Applied Psychology**3 Units***Advisory: Eligibility for ENGL 100 C.*

Term hours: 54 lecture. This course examines the principles of psychology and its research as it applies to everyday living. These principles are explored in the context of college life, interpersonal relationships, work and career. Focus areas include adjustment, health, stress, sexuality and psychological disorders. Applied Psychology is not the same as PSY 101 C Introduction to Psychology and cannot be taken in place of PSY 101 C. (CSU, CSU GE, C-ID: PSY 115)

PSY 120 C Human Sexuality**3 Units***Advisory: Eligibility for ENGL 100 C.*

Term hours: 54 lecture. This course is an overview of the psychological and psychobiological aspects of human sexuality. The course takes an interdisciplinary approach dealing with the entire area of human sexual behavior viewed in the context of the total integrated personality. (UC/CSU, AA GE, CSU GE, IGETC, C-ID: PSY 130)

PSY 131 C Cross-Cultural Psychology**3 Units**

Formerly PSY 237 C

Advisory: Eligibility for ENGL 100 C.

Term hours: 54 lecture. This course is an introduction to culture's influence on human behavior and mental processes. Beginning with an examination of theoretical definitions of culture, the course covers a broad range of theories and research findings regarding cultural influences on human behavior and cognitive processes (life-span development, abnormal behavior and mental health, self-concept, emotion, motivation, learning, intelligence, perception, memory, communication, social cognition, and social behavior). The diversity of human expression is examined in contexts ranging from everyday modes of functioning to family and work relationships. By providing students with a non-judgmental understanding of how culture influences human behavior, this course will make them more equipped to interact in a world where there is increasing contact among different cultures. In addition, students will gain knowledge in cross-cultural research methodology. (UC/CSU, CSU GE, IGETC, CUL DIV)

PSY 139 C Developmental Psychology**3 Units***Advisory: Eligibility for ENGL 100 C.*

Term hours: 54 lecture. This course is a study of emotional, intellectual, social and physical growth patterns from conception to death. It emphasizes an integrated approach to each life phase. It also examines the influence of heredity and environment in the life span. The study also includes applicable theories of development. (UC/CSU, CSU GE, IGETC, C-ID: PSY 180)

PSY 145 C Child Psychology**3 Units***Advisory: Eligibility for ENGL 100 C.*

Term hours: 54 lecture. This course explores physical, cognitive, communicative/linguistic, and socio-emotional development of the child from conception through adolescence across diverse cultures with emphasis on the learning process. Education and teaching issues related to children are highlighted. (UC/CSU, AA GE, CSU GE, IGETC, C-ID: CDEV 100)

PSY 161 C Probability and Statistics - Social Sciences**4 Units**

Same as SOC 161 C

Prerequisite: MATH 040 C or MATH 041 C or MATH 024 C or Algebra II with grades of "C" or better and the assessment process.

Term hours: 72 lecture. This course provides an introduction to fundamental statistical concepts relevant to the social sciences but applicable to all disciplines. A conceptual approach is used to introduce students to topics of descriptive and inferential statistics including sampling, probability, central tendency, variability, correlation, regression, point estimation, interval estimation, and hypothesis testing. Also introduced are non-parametric statistics, such as chi-square, and parametric statistics, such as t-tests and ANOVA. The course includes applications of technology for statistical analysis including the interpretation of the relevance of the statistical findings. Applications use data from the behavioral and social sciences of psychology, sociology, anthropology, geography, economics, political science and the life sciences, health sciences, and education. This course is open to all students who meet the prerequisite, and it is required for psychology majors. This course is strongly recommended for all social sciences majors. Students who receive credit for this course may not receive credit for MATH 120 C. Duplicate credit not granted for PSY 161HC, SOC 161 C, or SOC 161HC. (UC Credit Limitation/CSU, AA GE, CSU GE, IGETC, C-ID: SOCI 125)

PSY 161HC Honors Probability and Statistics - Social Sciences**4 Units**

Same as SOC 161HC

Prerequisite: MATH 040 C or MATH 041 C or MATH 024 C or Algebra II with grades of "C" and the assessment process.

Term hours: 72 lecture. This honors course provides an introduction to fundamental statistical concepts relevant to the social sciences but applicable to all disciplines. A conceptual approach is used to introduce students to topics of descriptive and inferential statistics including sampling, probability, central tendency, variability, correlation, regression, point estimation, interval estimation, and hypothesis testing. Also introduced are non-parametric statistics, such as chi-square, and parametric statistics, such as t-tests and ANOVA. The course includes applications of technology for statistical analysis including the interpretation of the relevance of the statistical findings. Applications use data from the behavioral and social sciences of psychology, sociology, anthropology, geography, economics, political science and the life sciences, health sciences, and education. This course is open to all students who meet the prerequisite, and it is required for psychology majors. This course is strongly recommended for all social sciences majors. Students who receive credit for this course may not receive credit for MATH 120 C. Duplicate credit not granted for PSY 161 C, SOC 161 C, or SOC 161HC. (UC/CSU, AA GE, CSU GE, IGETC, C-ID: SOCI 125)

PSY 202 C Research Methods in Psychology**4 Units***Prerequisite: PSY 101 C and PSY 161 C.*

Term hours: 54 lecture and 54 laboratory. This course encompasses the conceptual, ethical and technical aspects of designing and implementing research in the cognitive, behavioral and social sciences. Concepts are presented for proper application of the scientific method to psychological and social research using quantitative and qualitative techniques. The use of current technology to acquire, process, and analyze data is integrated throughout the course. Emphasis is placed on proper communication and presentation of completed research. (UC/CSU, CSU GE, IGETC, C-ID: PSY 205B)

PSY 221 C The Brain and Behavior 3 Units*Prerequisite: PSY 101 C with a grade of "C" or better.*

Term hours: 54 lecture. This course examines the neurophysiological processes associated with mental processes and behavior. Emphasis is placed on the structure and function of the brain and other central nervous system structures. Related processes such as the autonomic nervous system, the endocrine system and the immune system are also studied. Specific topics studied in the context of the brain include learning, sensation, perception, emotion, motivation, cognition, memory, stress, psychological disorders, and brain dysfunctions. (UC/CSU, CSU GE, IGETC, C-ID: PSY 150)

PSY 222 C Abnormal Psychology 3 Units*Prerequisite: PSY 101 C with a minimum grade of "C".**Advisory: Eligibility for ENGL 100 C.*

Term hours: 54 lecture. This course is a systematic study of psychopathology. This course presents a scientific survey of the subfield of psychology interested in researching the nature and causes of deviant or unusual human behavior both within and across cultures. This course surveys types of abnormal behavior, the process of assessing and diagnosing abnormal behavior, the therapeutic modalities used to treat abnormal behavior, and the scientific methods used to conduct research on abnormal behavior. This course draws upon DSM diagnostic criteria to classify abnormal behavior, and humanistic, cognitive, behavioral, cross-cultural, psycho-dynamic, and biologically-based models and theories to frame an understanding of abnormal behavior. Issues relating to research, treatment and forensic psychology are considered. (UC/CSU, CSU GE, IGETC, C-ID: PSY 120)

PSY 251 C Social Psychology 3 Units*Advisory: PSY 101 C with a grade of "C" or better.*

Term hours: 54 lecture. This course examines the basic theories, concepts, and empirical findings in such areas as social perception, social cognition, prejudice, discrimination, interpersonal attraction, conformity and obedience, bystander effects, social aggression, group dynamics, attribution theory, and development of self in the social setting. (UC/CSU, AA GE, CSU GE, IGETC, C-ID: PSY 170)

PSY 255 C Psychology of Aging 3 Units

Same as HUSR 255 C

Term hours: 54 lecture. This course examines the biological, physiological, cognitive, personality, developmental, intimacy and sexual aspects of the ongoing aging process. Critical life issues for elders and for those who live and work with them are explored. These issues include physical health, mental health, health care policy, caregiving, dependency and positive aging strategies. Duplicate credit not granted for HUSR 255 C. (UC/CSU, AA GE, CSU GE, IGETC)

PSY 298 C Psychology Seminar .5 to 12 Units*Prerequisite: May be required.**Corequisite: May be required.**Advisory: May be required.*

Term hours: 0-216 lecture and/or 0-648 laboratory depending on units attempted. This is a lecture/discussion type course developed on a particular limited problem or topic of interest to students. It is designed for able students who wish to increase their knowledge of a particular topic concerning which no other regular class is offered. A paper or group activity may be requested. Credit may range from 1/2 unit to 12 units. Consult class schedule for the offerings in a particular semester. May be taken for credit 1-4 times. Pass/No Pass or Pass/No Pass/Letter Grade Option or Standard Letter Grade. Fees may be required-Payable at Registration. (UC Credit Limitation/CSU)

PSY 299 C Psychology Independent Study 1 Unit*Prerequisite: Approved Independent Study Learning Contract.*

Varying hours of scheduled conferences per week according to instructor. Independent study is for able students who wish to extend their knowledge of a particular area through individual research and study. It is thought that topics might develop out of a curiosity stimulated in a regular class. The student would then contact the supervising instructor to develop a contract for his/her particular interest so that they could learn more regarding their special topic. May be taken for credit 3 times. (UC Credit Limitation/CSU)

Radiologic Technology

Division of Health Science

Division Dean — Rebecca Gomez, Interim*Faculty*

Michael Frianeza

Lynn Mitts

Barry Siegel

Counselors

Kelly Carter

Denise Vo

Doreen Villaseñor

PROGRAM LEARNING OUTCOMES (PLOs)

Radiologic Technology

A student who completes the Radiologic Technology program will be able to:

- Apply positioning skills in all required radiographic examinations.
- Select appropriate technical factors for radiographic examinations.
- Practice radiation protection for all radiographic examination.
- Employ proper patient care techniques.
- Demonstrate oral communication skills.
- Demonstrate written communication skills.
- Relate to and anticipate the needs of the doctors and technologists.
- Adjust to changes, situations, patient conditions, and deviation from the normal routine.
- Demonstrate knowledge of ethical requirements for an entry level radiographer along with ethical practices in a healthcare setting.
- Understand his/her professional obligations upon gaining the ARRT status.

ASSOCIATE IN SCIENCE DEGREE

RADIOLOGIC TECHNOLOGY

PROGRAM

Program Code: 1S03789

MISSION STATEMENT

The Cypress College Department of Radiologic Technology provides a high quality education to prepare a diverse population of students with entry level skills needed to become competent and confident radiographers.

PROGRAM GOALS AND OBJECTIVES

1. To provide students with a balance of instruction in radiologic technology courses as well as support courses.
2. To provide students with knowledge and skill to perform radiologic technology procedures.
3. To facilitate development of applied skills in effective communication, critical thinking, and problem solving in the practice of radiography.
4. To provide clinical experience compliment didactic instruction and develop clinical skills required for professional practice.
5. To provide an environment that encourages personal and professional growth.
6. To promote values of compassion, respect, understanding, and dignity in providing care to patients during imaging procedures.
7. To provide the health care community with graduate entry level radiographers skilled in diagnostic imaging procedures.

MINIMUM STANDARDS FOR APPLICANTS

1. Eligibility for admission to Cypress College.
2. High school graduation, or completion of the General Education Development (GED) test, or high school proficiency test.
3. Minimum age of 17 years. Must be 18 years old at the start of clinical training.
4. Present evidence of good physical and mental health, as determined by medical examination upon admission to program and prior to enrollment.
5. Overall GPA of 2.0 in all college classes taken.
6. Must have own transportation to all affiliated hospitals.
7. Completion of program prerequisites.

APPLICATION PROCEDURES

1. A separate application, in addition to the college application form, is required for admission into the Radiologic Technology program.
2. Application must be completed **online** during the month of **February**. Please see the **Health Science Application link** on the Radiology Technology home page.
3. Applicants must submit official transcripts (except Cypress and Fullerton Colleges) and signature page of application **in person** to the Health Science Applications office. Health Science Building, Cypress College 9200 Valley View Street, Cypress, California 90630-5897 by **March 15**. Please bring photo identification.
4. It is the applicant's responsibility to verify that evidence of criteria is on file.

SELECTION PROCEDURES

1. Applications normally exceed capacity. Selection of applicants is based on accumulation of points. (Criteria is subject to change. For information see a Health Science Counselor.)

PROGRAM PREREQUISITES

Foundation courses are required prior to admission to the program. The following required courses and all GE/graduation requirements must be completed prior to application with a minimum grade of "C" in each course to be considered for the fall (August) class. Once a passing grade is achieved and program application requirements are met courses may not be repeated for a higher grade.

| | | |
|------------|-------------------------------|-----|
| HS 145 C | Survey of Medical Terminology | 3 |
| BIOL 210 C | Anatomy and Physiology | 5 |
| | or | |
| BIOL 231 C | General Human Anatomy | (4) |
| RADT 142 C | Radiologic Electronics | 4 |
| RADT 146 C | Introduction to Radiography | 4 |
| MATH 040 C | Intermediate Algebra | 4 |

After receiving the degree and after completing the clinical internship, the student will be eligible to apply for admission to the state examination and the certification examination administered by the American Registry of Radiologic Technologists (ARRT). The program in Radiography is accredited by the Joint Review Committee on Education in Radiologic Technology (JRCERT).

JRCERT

20 North Wacker Drive, Suite 2850
Chicago, IL 60606-3182
(312) 704-5300
(312) 704-5304 (FAX)
email: mail@jrcert.org
www.jrcert.org

RADIOLOGIC TECHNOLOGY CURRICULUM

Radiologic Technology courses must be taken in a specific sequence. Students must obtain a minimum grade of "C" in all required courses to continue in the program. The three (3) semester internships will begin during the summer session following semester 2 of the curriculum and continue until June of the following year.

All courses, including general education courses, to satisfy the Associate Degree (refer to Cypress' Associate Degree requirements) must be completed prior to application. Upon completion of the program and Associate Degree requirements, the student will be eligible for the State Certification and National Registry Examinations. For further information, contact a Health Science Counselor, (714) 484-7270.

To earn an Associate Degree students must complete: (1) all major course requirements with a minimum grade of "C"; (2) 25 units of General Education Graduation Requirements with a grade of "C" or better; (3) the cultural diversity and reading requirements with a "C" or better; (4) any elective courses to complete a minimum of 60 units; and, (5) have a minimum GPA of 2.0. At least 50% of all major course work must be completed at Cypress College.

Required Courses are listed in suggested sequence:

| | | Units |
|----------------------------|------------------------------|--------------|
| SEMESTER 1 | | |
| RADT 148 C | Radiologic Technology | 4 |
| RADT 150 C | Radiologic Positioning | 5 |
| *RADT 153 C | Radiography Patient Care | 3 |
| *HS 147 C | Survey of Disease | 3 |
| SEMESTER 2 | | |
| RADT 247 C | Radiographic Positioning | 5 |
| RADT 251 C | Radiology Externship | 7 |
| RADT 162 C | Radiology Special Procedures | 3 |
| *RADT 252 C | Radiobiology | 1.5 |
| *RADT 253 C | Radiation Laws and Ethics | 1.5 |
| SUMMER INTERSESSION | | |
| RADT 254 C | Clinical Internship I | 6.5 |
| RADT 196 C | Selected Topics I | 1 |
| SEMESTER 3 | | |
| RADT 255 C | Clinical Internship II | 12 |
| RADT 197 C | Selected Topics II | 1 |
| RADT 260 C | Fluoroscopy Permit Course | 3 |
| SEMESTER 4 | | |
| RADT 256 C | Clinical Internship III | 12 |
| RADT 198 C | Selected Topics III | 1 |

Note: Non-refundable supplemental materials charges will apply to some of the above courses in this program.

| | |
|-----------------------------|-------------|
| Total Units Required | 69.5 |
|-----------------------------|-------------|

*May be taken prior to enrollment in the program.

CONTINUING EDUCATION COURSES

| | | Units |
|------------|-------------------------|--------------|
| RADT 262 C | Cross-Sectional Imaging | 1 |

IMAGING TECHNOLOGIST ASSISTANT CERTIFICATE**Program Code: 1C10449**

The Imaging Technologist Assistant Program prepares a student for an entry-level position as an imaging assistant in a health care facility such as a hospital, private physician's office, or clinic. This program can be completed in one year. To earn a certificate the student must complete the 16 units of required courses with a minimum grade of "C." At least 50% of all course work must be completed at Cypress College.

Required courses are listed in suggested sequence:

| | | Units |
|-----------------------------|-------------------------------|--------------|
| ENGL 100 C | College Writing | 4 |
| HS 145 C | Survey of Medical Terminology | 3 |
| CIS 111 C | Computer Information Systems | 3 |
| RADT 153 C | Radiography Patient Care | 3 |
| RADT 146 C | Introduction to Radiography | 4 |
| Total Units Required | | 17 |

RADIOLOGIC TECHNOLOGY CERTIFICATE**Program Code: 1C21114**

To earn a certificate, students must have previously earned an Associate Degree and have completed all of the Cypress College Radiologic Technology Program requirements with a minimum grade of "C." At least 50% of all course work must be completed at Cypress College.

MINIMUM STANDARDS FOR APPLICANTS

1. Eligibility for admission to Cypress College.
2. High school graduation, or completion of the General Education Development (GED) test, or high school proficiency test.
3. Minimum age of 17 years. Must be 18 years old at the start of clinical training.
4. Present evidence of good physical and mental health, as determined by medical examination upon admission to program and prior to enrollment.
5. Overall GPA of 2.0 in all college classes taken.
6. Must have own transportation to all affiliated hospitals.
7. Completion of program prerequisites.

APPLICATION PROCEDURES

1. A separate application, in addition to the college application form, is required for admission into the Radiologic Technology program.
2. Applications must be completed **online** during the month of **February**. Please see the **Health Science Application link** on the Radiology Technology home page.
3. Applicants must submit official transcripts (except Cypress and Fullerton Colleges) and signature page of application **in person** to the Health Science Applications office, Health Science Building, Cypress College, 9200 Valley View Street, Cypress, California 90630-5897 by **March 15**. Please bring photo identification.
4. It is the applicant's responsibility to verify that evidence of criteria is on file.

SELECTION PROCEDURES

Applications normally exceed capacity. Selection of applicants is based on accumulation of points. (Criteria is subject to change. For information see a Health Science Counselor.)

PROGRAM PREREQUISITES

Foundation courses are required prior to admission to the program. The following required courses and all GE/graduation requirements must be completed prior to application with a minimum grade of "C" in each course to be considered for the fall (August) class. Once a passing grade is achieved and program application requirements are met courses may not be repeated for a higher grade.

| Course # | Title | Units |
|-----------------|-------------------------------|--------------|
| HS 145 C | Survey of Medical Terminology | 3 |
| BIOL 210 C | Anatomy and Physiology | 5 |
| | or | |
| BIOL 231 C | General Human Anatomy | (4) |
| RADT 142 C | Radiologic Electronics | 4 |
| RADT 146 C | Introduction to Radiography | 4 |
| MATH 040 C | Intermediate Algebra | 4 |

RADIOLOGIC TECHNOLOGY CURRICULUM

Radiologic Technology courses must be taken in a specific sequence. Students must obtain a minimum grade of “C” in all required courses to continue in the program. The three (3) semester internships will begin during the summer session following semester 2 of the curriculum and continue until June of the following year.

All courses, including general education courses, to satisfy the Associate Degree (refer to Cypress’ Associate Degree requirements) must be completed prior to application. Upon completion of the program and Associate Degree requirements, the student will be eligible for the State Certification and National Registry Examinations. For further information, contact a Health Science Counselor, (714) 484-4270.

Required Courses are listed in suggested sequence:

| SEMESTER 1 | | Units |
|-----------------------------|------------------------------|--------------|
| RADT 148 C | Radiologic Technology | 4 |
| RADT 150 C | Radiologic Positioning | 5 |
| *RADT 153 C | Radiography Patient Care | 3 |
| *HS 147 C | Survey of Disease | 3 |
| SEMESTER 2 | | Units |
| RADT 247 C | Radiographic Positioning | 5 |
| RADT 251 C | Radiology Externship | 7 |
| RADT 162 C | Radiology Special Procedures | 3 |
| *RADT 252 C | Radiobiology | 1.5 |
| *RADT 253 C | Radiation Laws and Ethics | 1.5 |
| SUMMER INTERSESSION | | Units |
| RADT 254 C | Clinical Internship I | 6.5 |
| RADT 196 C | Selected Topics I | 1 |
| SEMESTER 3 | | Units |
| RADT 255 C | Clinical Internship II | 12 |
| RADT 197 C | Selected Topics II | 1 |
| RADT 260 C | Fluoroscopy Permit Course | 3 |
| SEMESTER 4 | | Units |
| RADT 256 C | Clinical Internship III | 12 |
| RADT 198 C | Selected Topics III | 1 |
| Total Units Required | | 69.5 |

Note: Non-refundable supplemental materials charges will apply to some of the above courses in this program.

CONTINUING EDUCATION COURSES

| (Recommended Not Required) | | Units |
|-----------------------------------|-------------------------|--------------|
| RADT 262 C | Cross-Sectional Imaging | 1 |

*May be taken prior to enrollment in program.

ULTRASOUND/MEDICAL SONOGRAPHY — now known as Diagnostic Medical Sonography and is located under this new name in the catalog.

Radiologic Technology (RADT)

RADT 142 C Radiologic Electronics **4 Units**

Term hours: 72 lecture. This is a course for students preparing for radiologic technology and medical sonography programs. Basic knowledge of scientific units, the structure of matter, electromagnetic radiation and sound energy, electromagnetism, the imaging system, x-ray production and interaction with matter will be discussed. (CSU)

RADT 146 C Introduction to Radiography **4 Units**

Term hours: 72 lecture. This course prepares the student for the radiography program. Material covered in this course include x-ray tube construction and production, radiographic quality and techniques, film/screen characteristics, digital and chemical processing, digital imaging, grid utilization, beam limitation, radiation protection, and quality assurance. (CSU)

RADT 148 C Radiologic Technology **4 Units**

Prerequisite: Admission to Radiologic Technology Program.

Term hours: 54 lecture and 54 laboratory. This course offers a study of the principles of radiographic technique, factors influencing radiographic quality, beam restricting devices and grid utilization. Also included are the physics and principles of digital imaging along with artifacts and quality control. Lab includes experiments with technical factors for improved image quality and written image analysis. \$50.00 Material Fee - PAYABLE AT REGISTRATION. (CSU)

RADT 150 C Radiologic Positioning **5 Units**

Prerequisite: Admission to the Radiologic Technology Program.

Term hours: 72 lecture and 54 laboratory. This course offers positioning methods for the upper and lower extremities, pelvis, respiratory system, bony thorax, and abdomen along with practical applications of image evaluation and radiation protection. \$50.00 Material Fee - PAYABLE AT REGISTRATION. (CSU)

RADT 153 C Radiography Patient Care **3 Units**

Term hours: 54 lecture. This course on patient care and management is a lecture/demonstration class to teach aseptic techniques and special procedures used by radiology personnel in working with patients. It will include student participation in basic nursing techniques along with techniques in areas such as: operating rooms; isolation room; diagnostic and fluoroscopic rooms; neonatal intensive care unit; emergency room; and intensive care rooms. Students will be required to obtain cardiopulmonary resuscitation (CPR) certification from the American Heart Association. (CSU)

RADT 162 C Radiology Special Procedures **3 Units**

Prerequisite: Satisfactory completion of the first semester in the Radiologic Technology Program. Completion of or concurrent enrollment in RADT 148 C with a minimum grade of “C” and RADT 150 C, RADT 153 C, and HS 147 C all with minimum grades of “C”.

Corequisite: RADT 247 C and RADT 251 C.

Term hours: 45 lecture and 27 laboratory. This course provides the student with the theory and practice of basic techniques of venipuncture and the administration of contrast media. Emphasis will be placed on the types of contrast agents used for the various radiographic procedures. The student will perform both simulated and live venipuncture for contrast media injection. Basic Pharmacology will be discussed. Special imaging modalities such as: Digital Angiography; Computerized Tomography; Magnetic Resonance Imaging; Medical Sonography; Nuclear Medicine; and Radiation Therapy will be surveyed. \$22.00 Material Fee-Payable at Registration. (CSU)

RADT 196 C Selected Topics I **1 Unit**

Prerequisite: RADT 153 C, RADT 251 C and RADT 253 C with minimum grades of “C”.

Corequisite: RADT 254 C.

Term hours: 18 lecture. Comprehensive categorical review of radiologic technology to support the student in the clinical internship phase. Topics include patient care, image quality, and radiographic techniques. Case studies will be discussed. (CSU)

RADT 197 C Selected Topics II 1 Unit

Prerequisite: RADT 196 C and RADT 254 C with minimum grades of "C".

Corequisite: RADT 255 C and RADT 264 C.

Term hours: 18 lecture. Comprehensive categorical review of radiologic technology to support the student in the clinical internship phase. Topics include routine and fluoroscopic positioning, special imaging procedures, radiation protection, and radiobiology. Case studies will be discussed. (CSU)

RADT 198 C Selected Topics III 1 Unit

Prerequisite: RADT 255 C and RADT 197 C with minimum grades of "C" and RADT 260 C.

Corequisite: RADT 256 C.

Term hours: 18 lecture. Comprehensive categorical review of radiologic technology to support the student in the clinical internship phase. Topics include of quality control and assurance, radiation physics, and medical law and ethics. Case studies will be discussed. (CSU)

RADT 247 C Radiographic Positioning 5 Units

Prerequisite: Satisfactory completion of first semester Radiologic Technology Program. Completion of or concurrent enrollment in RADT 148 C, RADT 150 C, RADT 153 C and HS 147 C with minimum grades of "C".

Corequisite: RADT 162 C and RADT 251 C.

Term hours: 72 lecture and 54 laboratory. This course offers positioning methods for the skull, urinary system, vertebral column, and digestive system. Trauma positioning and surgical/mobile techniques are discussed along with image evaluation and radiation protection for all procedures. \$33.00 Material Fee-Payable at Registration. (CSU)

RADT 251 C Radiology Externship 7 Units

Prerequisite: Satisfactory completion of the first (Fall) semester in the Radiologic Technology Program and RADT 150 C with minimum grades of "C".

Term hours: 36 lecture and 288 hours in supervised training and observation in an approved clinical affiliate. This course provides an introduction to specialized imaging exams to include fluoroscopy, hysterosalpingography, pediatrics, orthoroentgenography, mammography, arthrography, and myelography. The clinical externship will provide training in an approved clinical affiliate. (CSU)

RADT 252 C Radiobiology 1.5 Units

Prerequisite: RADT 146 C, and BIOL 231 C or BIOL 210 C and HS 145 C all with minimum grades of "C".

Term hours: 27 lecture. This course is designed to provide the principles of radiation interaction with cells, tissues, and the body as a whole. Factors affecting biological responses are presented, including early and late effects of radiation exposure. The principles of radiation protection along with the responsibilities of the radiographer for patients, personnel, and the public are included. (CSU)

RADT 253 C Radiation Laws and Ethics 1.5 Units

Prerequisite: RADT 153 C with a minimum grade of "C".

Term hours: 27 lecture. An introduction to legal terminology, concepts, and principles for radiographers will be presented. Topics include misconduct, malpractice, legal and professional standards and the scope of practice. The importance of proper documentation and informed consent is emphasized. The student will examine a variety of ethical issues and dilemmas found in clinical practice. (CSU)

RADT 254 C Clinical Internship I 6.5 Units

Prerequisite: RADT 162 C, RADT 247 C, RADT 251 C, RADT 252 C and RADT 253 C with minimum grades of "C".

Corequisite: RADT 196 C.

Term hours: 387 laboratory. This course begins the internship phase of the Radiologic Technology Program. Students are assigned to selected clinical education centers which provide supervised clinical training in the Department of Radiology in affiliated hospitals. Internship of approximately 40 hours per week are subject to rearrangement by hospital/facility. Clinical experiences shall be designed to provide patient care and assessment and competent performance of radiologic imaging exams of the chest, abdomen and extremities. (CSU)

RADT 255 C Clinical Internship II 12 Units

Prerequisite: RADT 196 C and RADT 196 C with minimum grades of "C".

Corequisite: RADT 260 C.

Term hours: 720 laboratory. This course begins the twelve month continuous internship phase of the Radiologic Technology Program. Students are assigned to selected clinical education centers which provide supervised clinical training with the Department of Radiology. Internship of 40 hours per week extends through intersessions and are subject to rearrangement by hospital/facility. Clinical practice experiences shall be designed to provide patient care and assessment, competent performance of radiologic imaging and total quality management. (CSU)

RADT 256 C Clinical Internship III 12 Units

Prerequisite: RADT 197 C and RADT 255 C with minimum grades of "C" and RADT 260 C.

Corequisite: RADT 198 C.

Term hours: 720 laboratory. This course is a continuation of the internship phase of the Radiologic Technology Program. Students are assigned to selected clinical education centers which provide supervised clinical training in the Department of Radiology in affiliated hospitals. Internship of approximately 40 hours per week are subject to rearrangement by hospital/facility. Clinical experiences shall be designed to provide patient care and assessment and competent performance of radiologic imaging exams including special procedures, surgical, trauma, and pediatric exams. (CSU)

RADT 260 C Fluoroscopy Permit Course 3 Units

Prerequisite: Satisfactory completion of the Summer session in the Radiologic Technology Program and RADT 254 C Clinical Internship I with a minimum grade of "C".

Term hours: 54 lecture. This course will provide the knowledge to operate fluoroscopy equipment efficiently and safely. Upon successful completion of the course, students will receive a certificate of completion and be eligible to qualify for the California State Technologists Fluoroscopy Permit. (CSU)

RADT 262 C Cross-Sectional Imaging 1 Unit

Term hours: 18 lecture. This course correlates knowledge and practice of diagnostic imaging with cross-sectional anatomy of the brain, skull, chest, thorax, spine, abdomen, and pelvis. Diagnostic imaging includes the ability to work with sonography, computerized tomography, and magnetic resonance imaging. A knowledge of medical terminology and anatomy is recommended. (CSU)

RADT 299 C Imaging Independent Study .5 to 2 Units

Prerequisite: Approved Independent Study Learning Contract.

Term hours: Lecture/lab hours will vary according to credit given. This course is designed for capable students enrolled in the Radiologic Technology program or options of the program who wish to increase their knowledge and experience in applied areas. Students will participate in independent study on assigned areas under staff supervision. (CSU)

Recreation

Division of Kinesiology and Athletics

Division Dean — Richard Rams

Faculty

Larry Beidler

Jeff Benito

Counselor

Dana Bedard

TRANSFER PROGRAM — RECREATIONAL LEADERSHIP

Students should consult a counselor or www.assist.org for lower division major requirements for most California public universities. (See the Standard Definitions section of the catalog for a description of ASSIST.) Students transferring to an independent college/university should consult the catalog of the individual school and a counselor for lower division major requirements.

Recreation (REC)

REC 100 C Foundations of Recreation and Leisure Services **3 Units**

Term hours: 54 lecture. This course is the foundation for an introduction to the broad field of recreation and leisure services. The class will include the relationship of recreation to the individual and society. This course is part of the Recreation Assistant Certification. (CSU)

REC 101 C Principles of Community Recreation **3 Units**

Term hours: 54 lecture. This course is an introduction to a variety of recreational activities suitable for a community recreation program. The class will study the various agencies and institutions that provide opportunities for community recreation. The class will emphasize interrelationships of these agencies. (CSU)

REC 102 C Recreation Leadership and Diverse Groups **3 Units**

Term hours: 54 lecture. Application and development of leadership skills in the recreation setting. Emphasis on applicable leadership techniques including working with groups consisting of representatives from diverse populations such as those with disabilities or special needs, cultural and social differences, and diversity of all ages. This course is part of Recreation Assistant Certification. (CSU, CUL DIV)

REC 103 C Organized Fall Sports Activity-Recreation **2 Units**

Term hours: 18 lecture and 54 laboratory. This course is a survey of basic terminology and skills of fall sports. The basic techniques of teaching, organizing, and promoting interest in individual and team fall sports are included. Students will be involved in organizing and promoting the college intramural sports program. (CSU)

REC 104 C Organized Spring Sports Activity-Recreation **2 Units**

Term hours: 18 lecture and 54 laboratory. This course is a survey of basic terminology and skills of spring sports. The basic techniques of teaching, organizing, and promoting interest in individual and team spring sports are included. Students will be involved in organizing and promoting the college intramural sports program. (CSU)

REC 106 C Outdoor Recreation and Camp Counseling **3 Units**

Term hours: 54 lecture. This course will emphasize the history, development and trends of organized camping and other outdoor recreation skills. The class will include leadership training in camp counseling with special emphasis on practical skills in camping, fire building, outdoor cooking, tenting, and camp crafts. This class is recommended for recreation majors and students interested in outdoor recreation. (CSU)

REC 107 C Recreation for Special Groups **3 Units**

Term hours: 54 lecture. This class is an introduction to the relationship of recreation and special groups (i.e. adolescent, older adults, individuals with intellectual and physical disabilities). The course will emphasize social development and how to integrate special groups into recreation programs with adoption of all forms of recreation. (CSU)

REC 298 C Recreation Seminar **.5 to 12 Units**

Prerequisite: May be required.

Corequisite: May be required.

Advisory: May be required.

Term hours: 0-216 lecture and/or 0-432 laboratory depending on units attempted. This class will utilize a lecture/lab-activity approach to various topics in recreation. A variety of classes will be offered in order to introduce students to new experiences in recreation. May be taken for credit 1-4 times. Pass/No Pass or Pass/No Pass/Letter Grade Option or Standard Letter Grade. Fees may be required-Payable at Registration. (CSU)

Secretarial — See Computer Information Services (CIS)

Social Sciences

Division of Social Sciences

Division Dean — Lisa Gaetje, Interim

Counselors

Therese Mosqueda-Ponce

Daniel Pelletier

Social Science (SOSC)

SOSC 295 C Research Methods-Oral History **2 Units**

Same as HIST 295 C

Term hours: 18 lecture and 54 laboratory. This course introduces students to the special techniques of tape-recorded interviews to document 20th century history. Areas of study will include interviewing techniques, historical editing and transcripts of interviews. This course does not satisfy General Education requirements in Social Science. (CSU)

SOSC 298 C Social Sciences Seminar .5 to 12 Units*Prerequisite: May be required.**Corequisite: May be required.**Advisory: May be required.*

Term hours: 0-216 and/or 432 laboratory depending on units attempted. This is a lecture/discussion type course developed on a particular limited problem or topic of interest to students. It is designed for able students who wish to increase their knowledge of a particular topic concerning which no other regular class is offered. A paper or group activity may be requested. Credit may range from 1/2 unit to 12 units. Consult class schedule for the offerings a particular semester. May be taken for credit 1-4 times. Pass/No Pass or Pass/No Pass/Letter Grade Option or Standard Letter Grade. Fees may be required—Payable at Registration. (UC Credit Limitation/CSU)

SOSC 299 C Social Science - Independent Study 1 Unit*Prerequisite: Approved Independent Study Learning Contract.*

Term hours: 18 lecture. Independent study is for students who wish to extend their knowledge of a particular area through individual research and study. It is thought that topics might develop out of a curiosity stimulated in a regular class. The student would then contact the supervising instructor to develop a contract for his/her particular interest so he/she could learn more regarding their special topic. May be taken for credit 4 times. (UC Credit Limitation/CSU)

Sociology

Division of Social Sciences

Division Dean — Lisa Gaetje, Interim*Faculty*

Larry Curiel
James Dedic
Regina Rhymes

Counselors

Therese Mosqueda-Ponce
Daniel Pelletier

PROGRAM LEARNING OUTCOMES (PLOs)

The courses taught by this department contribute to the General Education and Basic Skills Program Learning Outcomes. Please refer to General Education and Basic Skills Program Learning Outcomes.

ASSOCIATE IN ARTS IN SOCIOLOGY FOR TRANSFER DEGREE (AA-T)

Program Code: 1A31003

This curriculum is designed to provide an opportunity for the Sociology major to achieve an Associate in Arts in Sociology for Transfer Degree which completes the first and second year requirements for transfer to a four-year public California institution. While at least a baccalaureate degree is recommended preparation for those considering professional careers, completion of this curriculum will demonstrate commitment to the field and provide comprehensive preparation for further academic study through upper-division course work at a four-year college or university. Students should consult a counselor, the Transfer Center and the catalog of the transfer college or university to plan a specific program of study to meet the college or university's requirements.

NOTE: Courses that fulfill major requirements for an Associate Degree for Transfer at Cypress College might not be the same as those required for completing the major at all transfer institutions offering a Baccalaureate Degree. The Associate in Arts in Sociology for Transfer Degree is designed to provide students with an introduction and overview of the field. Sociology is the study of social life, social systems, social change and the social causes and consequences of human behavior. It is based on the idea that the understanding of the dynamic structure of social life will allow analysis of present situations against the backdrop of larger social realities and lead to effective responses to those situations. The Sociology Degree for Transfer program includes the study of sociological theories and knowledge, the scientific foundations of sociology, and the application of the sociological perspective to various, specific areas of social life. It offers an opportunity to examine the field in detail and to identify possible personal directions for further study. Sociology gives students a solid basis for many career paths and can be enhanced with multidisciplinary study in related fields. The Student Transfer Achievement Reform Act (Senate Bill 1440, now codified in California Education Code sections 66746–66749) guarantees admission to a California State University (CSU) campus for any community college student who completes an “associate degree for transfer,” a newly established variation of the associate degrees traditionally offered at a California community college. The Associate in Arts for Transfer (AA-T) is intended for students who plan to complete a bachelor's degree in a similar major at a CSU campus. Students completing these degrees (AA-T) are guaranteed admission to the CSU system, but not to a particular campus or major. Students transferring to a CSU campus that does accept the AA-T will be required to complete no more than 60 units after transfer to earn a bachelor's degree (unless the major is designated “high-unit” major). This degree may not be the best option for students intending to transfer to a particular CSU campus or to a university or college that is not part of the CSU system. Students should consult with a counselor when planning to complete the degree for more information on university admission and transfer requirements.

To earn an Associate in Arts for Transfer (AA-T) students must complete: (1) a minimum of 19–20 semester units or 28.5–30 quarter units of major course requirements with a minimum grade of “C”; (2) California State University General Education Breadth requirements (CSU GE Breadth) or the Intersegmental General Education Transfer Curriculum (IGETC); (3) any elective courses to complete a minimum of 60 units of CSU transferable course work; (4) have an overall GPA of 2.0.

Required Core:

| (10–11 units) | | Units |
|---------------|--------------------------------------|-------|
| SOC 101 C | Introduction to Sociology | 3 |
| | or | |
| SOC 101HC | Honors Introduction to Sociology and | (3) |

Any two courses from the following:

| | | Units |
|-----------|--|-------|
| SOC 102 C | Social Problems | 3 |
| SOC 161 C | Probability and Statistics: Social Sciences | 4 |
| | or | |
| SOC 161HC | Honors Probability and Statistics: Social Sciences | (4) |
| | or | |
| PSY 161 C | Probability and Statistics: Social Sciences | (4) |
| | or | |
| PSY 161HC | Honors Probability and Statistics: Social Sciences | (4) |
| PSY 202 C | Research Methods in Psychology | 4 |

List A:

Select two courses from the list below, or any course from REQUIRED CORE not already taken.

| | Units |
|---|--------------|
| SOC 275 C Marriage and Family | 3 |
| SOC 225 C Sociology of Women | 3 |
| SOC 292 C Introduction to Criminology | 3 |
| | or |
| HUSR 292 C Introduction to Criminology | (3) |
| PSY 251 C Social Psychology | 3 |
| ETHS 101 C American Ethnic Studies | 3 |
| | or |
| ETHS 101HC Honors American Ethnic Studies | (3) |

List B:

Select one course from the list below, or any course from REQUIRED CORE or List A not already taken.

| | Units |
|---|--------------|
| SOC 277 C Sociology of Religion | 3 |
| PSY 120 C Human Sexuality | 3 |
| PSY 131 C Cross-Cultural Psychology | 3 |
| SOC 250 C Sociology of Aging | 3 |
| | or |
| HUSR 250 C Sociology of Aging | (3) |
| PSY 101 C Introduction to Psychology | 3 |
| | or |
| PSY 101HC Honors Introduction to Psychology | (3) |
| ANTH 102 C Cultural Anthropology | 3 |
| | or |
| ANTH 102HC Honors Cultural Anthropology | (3) |
| GEOG 160 C Cultural Geography | 3 |
| Total Units Required | 19–20 |

SOCIOLOGY TRANSFER PROGRAM

Students should consult a counselor or www.assist.org for lower division major requirements for most California public universities. (See the Standard Definitions section of the catalog for a description of ASSIST.) Students transferring to an independent college/university should consult the catalog of the individual school and a counselor for lower division major requirements.

Sociology (SOC)

SOC 101 C Introduction to Sociology 3 Units

Advisory: Eligibility for ENGL 100 C.

Term hours: 54 lecture. This course is an analysis of human relationships through a study of cultural origins, personality development, social interaction, community organization, collective behavior, institutional growth, social change, and social movements. Duplicate credit not granted for SOC 101HC. (UC/CSU, AA GE, CSU GE, IGETC, C-ID: SOCI 110)

SOC 101HC Honors Introduction to Sociology 3 Units

Advisory: Eligibility for ENGL 100 C.

Term hours: 54 lecture. This course is an enhanced version of Introduction to Sociology for honors students. This course is an analysis of human relationships through a study of cultural origins, personality development, social interaction, community organization, collective behavior, institutional growth, social change, and social movements. Duplicate credit not granted for SOC 101 C. (UC/CSU, AA GE, CSU GE, IGETC, C-ID: SOCI 110)

SOC 102 C Social Problems 3 Units

Advisory: Completion of SOC 101 C and eligibility for ENGL 100 C.

Term hours: 54 lecture. This course is an identification and analysis of selected contemporary social problems in American society and around the world. It includes problems of overpopulation, environmental destruction, war, race, poverty, sex inequality, aging, drug abuse, health, crime and violence. Alternative approaches to the resolution of these problems and identification of institutions and organizations involved in their resolution are emphasized. (UC/CSU, AA GE, CSU GE, IGETC, C-ID: SOCI 115)

SOC 161 C Probability and Statistics - Social Sciences 4 Units

Same as PSY 161HC

Prerequisite: MATH 040 C or MATH 041 C or MATH 024 C or Algebra II with grades of "C" or better and the assessment process.

Term hours: 72 lecture. This course provides an introduction to fundamental statistical concepts relevant to the social sciences but applicable to all disciplines. A conceptual approach is used to introduce students to topics of descriptive and inferential statistics including sampling, probability, central tendency, variability, correlation, regression, point estimation, interval estimation, and hypothesis testing. Also introduced are non-parametric statistics, such as chi-square, and parametric statistics, such as t-tests and ANOVA. The course includes applications of technology for statistical analysis including the interpretation of the relevance of the statistical findings. Applications use data from the behavioral and social sciences of psychology, sociology, anthropology, geography, economics, political science and the life sciences, health sciences, and education. This course is open to all students who meet the prerequisite, and it is required for psychology majors. This course is strongly recommended for all social sciences majors. Students who receive credit for this course may not receive credit for MATH 120 C. Duplicate credit not granted for PSY 161 C, PSY 161HC, or SOC 161HC. (UC Credit Limitation/CSU, AA GE, CSU GE, IGETC, C-ID: SOCI 125)

SOC 161HC Honors Probability and Statistics - Social Sciences 4 Units

Same as PSY 161HC

Prerequisite: MATH 040 C or MATH 041 C or MATH 024 C or Algebra II with minimum grades of "C" or better and the assessment process.

Term hours: 72 lecture. This honors course provides an introduction to fundamental statistical concepts relevant to the social sciences but applicable to all disciplines. A conceptual approach is used to introduce students to topics of descriptive and inferential statistics including sampling, probability, central tendency, variability, correlation, regression, point estimation, interval estimation, and hypothesis testing. Also introduced are non-parametric statistics, such as chi-square, and parametric statistics, such as t-tests and ANOVA. The course includes applications of technology for statistical analysis including the interpretation of the relevance of the statistical findings. Applications use data from the behavioral and social sciences of psychology, sociology, anthropology, geography, economics, political science and the life sciences, health sciences, and education. This course is open to all students who meet the prerequisite, and it is required for psychology majors. This course is strongly recommended for all social sciences majors. Students who receive credit for this course may not receive credit for MATH 120 C. Duplicate credit not granted for PSY 161 C, PSY 161HC, or SOC 161 C. (UC/CSU, AA GE, CSU GE, IGETC, C-ID: SOCI 125)

SOC 225 C Sociology of Women 3 Units

Advisory: Eligibility for ENGL 100 C.

Term hours: 54 lecture. This course covers an identification and analysis of the status of women in American society. Sociological issues pertinent to the conditions of women are examined, such as the social construction of gender, feminism, women's health, sexuality, relationships, employment, and familial roles. (UC/CSU, CSU GE, IGETC, C-ID: SOCI 140)

SOC 250 C Sociology of Aging**3 Units**

Same as HUSR 250 C

Term hours: 54 lecture. This course explores the concept of aging and sociological/cultural theories of aging. The gender, cross-cultural, economic, political and social policy aspects of aging in society and the world are examined. Critical life issues for elders and for those who live and work with them are explored. These issues include empowerment, care giving, social support, living arrangements, elder abuse, work, retirement, quality of life and death and dying. Duplicate credit not granted for HUSR 250 C. (UC/CSU, AA GE, CSU GE, IGETC)

SOC 275 C Marriage and Family**3 Units***Advisory: Eligibility for ENGL 100 C.*

Term hours: 54 lecture. This course is a study of the sociological factors involved in family relationships, courtship, marital adjustments and parenthood. This course examines various patterns of marriage and families within the United States. (UC/CSU, AA GE, CSU GE, IGETC, C-ID: SOCI 130)

SOC 277 C Sociology of Religion**3 Units***Advisory: Eligibility for ENGL 100 C.*

Term hours: 54 lecture. This course is an analysis of religion as a social institution. Emphasis will be placed on the influence that religion has on American society by examining the role religion plays in people's lives, and legitimates some existing social and economic arrangements. (UC/CSU, AA GE, CSU GE, IGETC)

SOC 292 C Introduction to Criminology**3 Units**

Same as HUSR 292 C

Term hours: 54 lecture. This course presents a scientific analysis of the nature, extent, and causes of violations of societal rules of behavior that are formally defined as crime and delinquency. The course includes an analysis of the theoretical perspectives that led to the development of criminal law and the administration of criminal justice, the patterns of criminality and delinquency, the impact of crime on social change, and the labeling, identification, characteristics, and the treatment of criminals and delinquents. Duplicate credit not granted for HUSR 292 C. (UC/CSU, CSU GE, IGETC, C-ID: SOCI 160)

SOC 298 C Sociology Seminar**.5 to 12 Units***Prerequisite: May be required.**Corequisite: May be required.**Advisory: May be required.*

Term hours: 0-216 lecture and/or 432 laboratory depending on units attempted. This is a lecture/discussion type course developed on a particular limited problem or topic of interest to students. It is designed for students who wish to increase their knowledge of a particular topic concerning which no other regular class is offered. A paper or group activity may be requested. Credit may range from 1/2 unit to 12 units. Consult class schedule for the offerings in a particular semester. May be taken for credit 1-4 times. Pass/No Pass or Pass/No Pass/Letter Grade Option or Standard Letter Grade. Fees may be required-Payable at Registration. (UC Credit Limitation/CSU)

SOC 299 C Sociology Independent Study**1 Unit***Prerequisite: Approved Independent Study Learning Contract.*

Term hours: 18 lecture. Independent study is for students who wish to extend their knowledge of a particular area through individual research and study. It is thought that topics might develop out of a curiosity stimulated in a regular class. Students would then contact the supervising instructor to develop a learning contract for their particular interest so that they could learn more regarding their chosen specific topic. May be taken for credit 4 times. (UC Credit Limitation/CSU)

Spanish

Division of Language Arts

Division Dean — Eldon Young*Faculty*

E. Alex Herrera

Jessica Puma

Counselors

Daniel Pelletier

Therese Mosqueda-Ponce

PROGRAM LEARNING OUTCOMES (PLOs)

The courses taught by this department contribute to the General Education and Basic Skills Program Learning Outcomes. Please refer to General Education and Basic Skills Program Learning Outcomes.

SPANISH TRANSFER PROGRAM

Students should consult a counselor or www.assist.org for lower division major requirements for most California public universities. (See the Standard Definitions section of the catalog for a description of ASSIST.) Students transferring to an independent college/university should consult the catalog of the individual school and a counselor for lower division major requirements.

Spanish (SPAN)

SPAN 050 C Public Service Spanish**3 Units**

Term hours: 54 lecture. This course is a basic communication course, for students who want to acquire a speaking knowledge for vocational needs in the fields of health-care, social welfare, law enforcement, hotel and restaurant industries, and business in general. Consideration also will be given to cultural topics. It is assumed that the student has no prior knowledge of the language. Pass/No Pass/Letter Grade Option.

SPAN 053 C Basic Spoken Spanish**3 Units**

Term hours: 54 lecture. This is a basic introductory course which emphasizes oral practice, pronunciation and vocabulary development. It is designed to develop a speaking and understanding knowledge of Spanish for use in everyday conversational situations. It is not open to native speakers of the language. Pass/No Pass/Letter Grade Option.

SPAN 098 C Spanish Seminar**.5 to 12 Units***Prerequisite: May be required.**Corequisite: May be required.**Advisory: May be required.*

Term hours: 0-216 lecture and/or 432 laboratory depending on units attempted. This seminar is for able students who wish to extend their knowledge of literature, language and culture through small group discussion. May be taken for credit 1-4 times. Pass/No Pass or Pass/No Pass/Letter Grade Option or Standard Letter Grade. Fees may be required-Payable at Registration.

SPAN 101 C Elementary Spanish I 5 Units

Term hours: 90 lecture. The course emphasizes the acquisition of basic skills in pronunciation, listening, speaking, reading, and writing. Students will be introduced to the culture, history, and geography of Spain and Latin America. Pass/No Pass/Letter Grade Option. (UC Credit Limitation/CSU, AA GE, CSU GE, C-ID: SPAN 100)

SPAN 102 C Elementary Spanish II 5 Units

Prerequisite: SPAN 101 C with grade of "C" or better, or one year of high school Spanish with a grade of "C" or better is recommended.

Term hours: 90 lecture. The course continues to emphasize the acquisition of basic skills in pronunciation, listening, speaking, reading, and writing. Students will increase their knowledge of the culture, history, and geography of Spain and Latin America through lectures, slides, films, and reading and writing assignments. Pass/No Pass/Letter Grade Option. (UC Credit Limitation/CSU, AA GE, CSU GE, IGETC, C-ID: SPAN 110)

SPAN 200 C Conversational Spanish 2 Units

Prerequisite: SPAN 102 C.

Term hours: 36 lecture. The course emphasizes extensive practice in oral expression and listening comprehension at intermediate and advanced levels of competency. The materials used provide a systematic practice of grammatical concepts, literary analysis and cultural appreciation. Pass/No Pass/Letter Grade Option. (CSU, CSU GE)

SPAN 201 C Spanish for Spanish Speakers I 5 Units

Prerequisite: A native or near-native speaking knowledge of Spanish for those who have had little or no formal education in the language.

Term hours: 90 lecture. This course is designed to address the needs of students with Spanish speaking background who have little or no formal training in Spanish. Emphasis will be placed on composition, advanced reading comprehension, standard vs. vernacular usages, and cross-language interference. The course's aim is to reinforce oral expression and comprehension, develop writing skills, build a wider base vocabulary, read Hispanic literature and provide an awareness of the language. Pass/No Pass/Letter Grade Option. Duplicate credit not granted for SPAN 101 C/102 C. (UC/CSU, AA GE, CSU GE, IGETC, C-ID: SPAN 220)

SPAN 202 C Spanish for Spanish Speakers II 5 Units

Prerequisite: SPAN 201 C.

Term hours: 90 lecture. This course is designed for students who are fluent in spoken, informal Spanish and who need to improve their writing, reading, and grammar skills. It furthers the mastery of formal, written communication in Spanish at the intermediate/advanced level while integrating in Hispanic, Latin American, and Chicano culture through increased practice in intermediate/advanced level readings. The course focuses on language challenges that Spanish speakers still encounter at the intermediate/advanced level, such as orthography, the inappropriate mix of English and Spanish in specific contexts, and standard Spanish as contrasted to regional variations. This course is conducted entirely in Spanish. Duplicate credit not given for SPAN 203 C. (UC Credit Limitation/CSU, AA GE, CSU GE, IGETC, C-ID: SPAN 230)

SPAN 203 C Intermediate Spanish III 4 Units

Prerequisite: SPAN 102 C with a grade of "C" or better, or two years of high school Spanish with a grade of "C" or better is required.

Term hours: 72 lecture. The course introduces the student to the more formal aspects of cultural appreciation through a selection of readings by modern Spanish and Spanish American authors. It also provides extensive practice in oral and written expression and a thorough review of grammatical concepts. Pass/No Pass/Letter Grade Option. (UC/CSU, AA GE, CSU GE, IGETC, C-ID: SPAN 200)

SPAN 204 C Intermediate Spanish IV 4 Units

Prerequisite: SPAN 203 C with a grade of "C" or better, or three years of high school Spanish with a grade of "C" or better.

Term hours: 72 lecture. The course continues to emphasize acquisition of the more formal aspects of cultural appreciation through a selection of advanced readings by modern Spanish and Spanish American authors. It also provides extensive practice in oral and written expression and a thorough review of grammatical concepts. Pass/No Pass/Letter Grade Option. (UC/CSU, AA GE, CSU GE, IGETC, C-ID: SPAN 210)

SPAN 298 C Spanish Seminar .5 to 12 Units

Prerequisite: May be required.

Corequisite: May be required.

Advisory: May be required.

Term hours: 0-216 lecture and/or 432 laboratory depending on units attempted. This seminar is for able students who wish to extend their knowledge of literature, language and culture through small group discussion. May be taken for credit 1-4 times. Pass/No Pass Or Pass/No Pass/Letter Grade Option or Standard Letter Grade. Fees may be required-Payable at Registration. (UC Credit Limitation/CSU)

SPAN 299 C Spanish Independent Study .5 to 2 Units

Prerequisite: Approved Independent Study Learning Contract.

Variable Unit Class. May be taken for credit 3 times. Pass/No Pass/Letter Grade Option.

Two hours conference per week for maximum credit. This course is designed for able students who wish to increase their knowledge of language through individual study or research. (UC Credit Limitation/CSU)

Theater Arts

Division of Fine Arts

Division Dean — Katy Realista

Faculty

James Hormel

Mark Majarian

Counselors

Renay Laguana-Ferinac

Renee Ssensalo

PROGRAM LEARNING OUTCOMES (PLOs)

Theater Department

- Given a performance or production setting, students will demonstrate their knowledge and comprehension of major theater practices and standards.
- Given a performance or production setting, students will use theatrical techniques to communicate to an audience.
- Given a performance or production setting, students will be able to analyze, evaluate and create production and performance elements.
- Given a performance or production setting, students will demonstrate their knowledge and ability to appreciate theater as an art form and their ability to collaborate with other theater practitioners as self defining artists.

Course Repeatability Limitations

Effective 2013, most active participatory courses in Art, Dance, Theater, Music, and Kinesiology/Physical Education are no longer repeatable. The courses in the table below are related in content and therefore have been identified in distinct “family” groupings in which students are limited to a maximum of 4 course enrollments per family (withdrawals and substandard grades will be counted towards the 4 enrollment maximum). Note: Exceptions for courses still designated as repeatable are indicated in course descriptions of the college catalog and class schedules with the statement, “May be taken for credit ____ times.” If students are majoring in any of these disciplines, they are advised to see their counselor to discuss options.

| DISCIPLINE | FAMILY/RELATED COURSES | COURSES RELATED IN CONTENT | LIMITATIONS |
|-------------------------|--|---------------------------------|--|
| Theater Arts | Acting Technique | THEA 120 C, 124 C, 125 C, 220 C | Students are limited to four (4) semester enrollments — in Active Participatory courses — whether in a single course or in a combination of courses grouped within a family. All enrollments in courses (including enrollments in the same repeatable course) within a family count toward the maximum enrollment limitation of four (4) semester enrollments. This includes evaluative (A, B, C, D, F, P, NP) and non-evaluative (I, IP, RD, and W) grades earned. All letter grades received will be counted in GPA. |
| | Musical Theater Technique | THEA 126 C, 127 C, 226 C | |
| | Acting for Camera | THEA 128 C, 228 C | |
| | Performance for Contemporary & Traditional | THEA 133 C, 136 C, 234 C | |
| | Performance for Musical Theater | THEA 132 C, 135 C, 232 C | |
| | Stage Crew | THEA 149 C, 150 C, 151 C, 152 C | |
| Theater Arts Exceptions | Vocational Competition | THEA 130 C Acting Workshop | |

ASSOCIATE IN ARTS IN THEATER ARTS FOR TRANSFER DEGREE (AA-T)

Program Code: 1A32187

This curriculum is designed to provide an opportunity for the Theater major to achieve an Associate in Arts in Theater for Transfer (AA-T in Theater) which completes the first and second year requirements for transfer to a four-year public California institution. While at least a baccalaureate degree is recommended preparation for those considering professional careers, completion of this curriculum will demonstrate commitment to the field and provide comprehensive preparation for further academic study through upper-division course work. The study of theater combines a critical study of theater with experiential practice in one or more of its component parts. Students explore the various areas of theater to build a foundation for future creative work. This curriculum specifically prepares the prospective transfer student for upper division course work in Theater or a similar major at a California State University (CSU) campus. Students should consult a counselor, the Transfer Center and the catalog of the transfer college or university to plan a specific program of study to meet the college or university's requirements.

Note: Courses that fulfill major requirements for an Associate Degree for Transfer at Cypress College might not be the same as those required for completing the major at all transfer institutions offering a Baccalaureate Degree. The Student Transfer Achievement Reform Act (Senate Bill 1440, now codified in California Education Code sections 66746–66749) guarantees admission to a California State University (CSU) campus for any community college student who completes an “associate degree for transfer,” a newly established variation of the associate degrees traditionally offered at a California community college. The AA-T is intended for students who plan to complete a bachelor's degree in a similar major at a CSU campus. Students completing these degrees (AA-T) are guaranteed admission to the CSU system, but not to a particular campus or major. Students transferring to a CSU

campus that does accept the AA-T will be required to complete no more than 60 units after transfer to earn a bachelor's degree (unless the major is designated “high-unit” major). This degree may not be the best option for students intending to transfer to a particular CSU campus or to a university or college that is not part of the CSU system. Students should consult with a counselor when planning to complete the degree for more information on university admission and transfer requirements. The completion of this curriculum will demonstrate commitment to the Theater field and provide comprehensive preparation for upper-division work.

To earn an AA-T in Theater students must complete the following requirements: (1) a minimum of 18 semester units or 27 quarter units in the Theater major with a minimum grade of “C”; (2) California State University General Education Breadth requirements (CSU GE Breadth) or the Intersegmental General Education Transfer Curriculum (CSU IGETC); (3) completion of 60 semester or 90 quarter units of CSU transferable course work; and (4) have an overall GPA of 2.0.

| Required Core: Select 3 courses from the following (9 units): | | Units |
|--|-------------------------------|--------------|
| THEA 100 C | Introduction to the Theater | 3 |
| | or | |
| THEA 102 C | World Theater History I | 3 |
| THEA 120 C | Acting I | 3 |
| THEA 132 C | Musical Theater Performance I | 3 |
| | or | |
| THEA 133 C | Rehearsal Performance I | 3 |

List A: Select 3 courses from the following (9 units). Please note if a student does not take THEA 132 C or THEA 133 C for the required core, one of these courses may be completed for these required 9 units, or a minimum of two Stage Crew courses may be completed for a total of 3 units only. (EX: 1 course taken at 1 unit and the second course taken at 2 units.)

| | Units |
|---|--------------|
| THEA 101 C Play Analysis | 3 |
| THEA 124 C Acting II | 3 |
| THEA 140 C Introduction to Theater Design | 3 |
| THEA 143 C Stagecraft | 3 |
| THEA 144 C Lighting Design Fundamentals | 3 |
| THEA 145 C Fundamentals of Costume Design | 3 |
| THEA 147 C Stage Makeup | 3 |
| THEA 132 C Musical Theater Performance I or | 2–3 |
| THEA 133 C Rehearsal Performance I or | 2–3 |
| THEA 149 C Stage Crew I — Running and/or | 1–2 |
| THEA 150 C Stage Crew II — Production Preparation and/or | 1–2 |
| THEA 151 C Stage Crew III — Costume/Makeup and/or | 1–2 |
| THEA 152 C Stage Crew IV — House/Box Office | 1–2 |
| Total Units Required | 18 |

ASSOCIATE IN ARTS DEGREE

THEATER ARTS

Program Code: 1A03779

This program is designed to prepare the student with a fundamental understanding and acquisition of knowledge in the theater arts discipline. The curriculum includes courses in theater production and acting as well as performance and production experience.

To earn an Associate Degree students must complete: (1) all major course requirements with a minimum grade of “C”; (2) 25 units of General Education Graduation Requirements; (3) cultural diversity and reading requirements; (4) any elective courses to complete a minimum of 60 units; and, (5) have a minimum GPA of 2.0. At least 50% of all major course work must be completed at Cypress College.

Courses that fulfill major requirements for an Associate Degree at Cypress College might not be the same as those required for completing the major at a transfer institution offering a Baccalaureate Degree. For information on specific university requirements, please consult with your counselor, or visit the Transfer Center.

Required courses are listed in suggested sequence:

| Course # | Title | Units |
|---|--------------------------------------|--------------|
| Twenty seven (27) units from the following Theater courses required. | | |
| Required courses are listed in suggested sequence: | | |
| THEA 100 C | Introduction to the Theater | 3 |
| THEA 102 C | World Theater History I or | 3 |
| THEA 107 C | Diversity in American Theater or | (3) |
| THEA 107HC | Honors Diversity in American Theater | (3) |
| THEA 120 C | Acting I | 3 |
| THEA 143 C | Stagecraft or | 3 |
| THEA 140 C | Introduction to Theater Design | (3) |
| THEA 124 C | Acting II or | 3 |
| THEA 126 C | Musical Theater Techniques I | (3) |
| THEA 144 C | Lighting Design Fundamentals or | 3 |
| THEA 146 C | Scene Painting | (3) |
| THEA 129 C | Voice and Diction or | 3 |
| THEA 127 C | Musical Theater Techniques II | (3) |
| THEA 145 C | Fundamentals of Costume Design or | 3 |
| THEA 147 C | Stage Makeup | (3) |
| THEA 125 C | Acting III | 3 |

Select 2–3 units from the following technique and performance classes according to emphasis:

| | Units |
|---|--------------|
| THEA 101 C Play Analysis | 3 |
| THEA 102 C World Theater History I | 3 |
| THEA 108 C Stage and Screenwriting | 3 |
| THEA 121 C Dynamic Movement for the Stage | 2 |
| THEA 128 C Acting for the Camera | 2 |
| THEA 130 C Acting Workshop | 3 |
| THEA 132 C Musical Theater Performance I | 2–3 |
| THEA 133 C Rehearsal Performance I | 2–3 |
| THEA 135 C Musical Theater Performance II | 2–3 |
| THEA 136 C Rehearsal Performance II | 2–3 |
| THEA 142 C Theater Sound and Recording | 2 |
| THEA 220 C Acting IV | 3 |
| THEA 225 C Directing for the Theater | 3 |
| THEA 228 C Advanced Acting for the Camera | 2 |
| THEA 232 C Advanced Musical Theater Performance | 2–3 |
| THEA 233 C Musical Theater Performance IV | 2–3 |
| THEA 234 C Rehearsal Performance III | 2–3 |
| THEA 238 C Rehearsal and Performance IV | 2–3 |
| THEA 149 C Stage Crew I — Running or | 1–2 |
| THEA 150 C Stage Crew II — Production Preparation or | (1)–(2) |
| THEA 151 C Stage Crew III — Costume/Makeup or | (1)–(2) |
| THEA 152 C Stage Crew IV — House/Box Office | (1)–(2) |
| THEA 236 C Summer Theater Workshop I | 1–2 |
| THEA 237 C Summer Theater Workshop II | 1–2 |
| Total Units Required | 29–30 |

ACTING AND FILM VIDEO PRODUCTION CERTIFICATE

Program Code: 1C33962

A synthesis of theater courses and multimedia arts courses, this certificate enables the student to develop the skills in acting and basic digital video production necessary for professional competency in the entertainment industry. The Acting and Film Video Production Certificate requires a total of 20–21 units, 18 of which are required courses as listed with a minimum grade of “C”. At least 50% of the course work must be completed at Cypress College.

| Required courses are listed in suggested sequence: | | Units |
|---|------------------------------------|--------------|
| THEA 120 C | Acting I | 3 |
| THEA 128 C | Acting for the Camera | 2 |
| THEA 228 C | Advanced Acting for the Camera | 2 |
| THEA 230 C | Directing Actors for Film/TV | 2 |
| MAD 188 C | Beginning Single Camera Prod or | 3 |
| MAD 109 C | Digital Video Production I/MAC | (3) |
| MAD 194 C | Beginning Motion Picture Prod | 3 |
| THEA 124 C | Acting II | 3 |
| Select 2–3 units from the following: | | Units |
| THEA 133 C | Rehearsal Performance I or | 2–3 |
| THEA 236 C | Summer Theater Workshop I | (2) |
| THEA 108 C | Stage and Screenwriting or | 3 |
| THEA 129 C | Voice and Diction | (3) |
| Total Units Required | | 20–21 |

COSTUME/MAKEUP DESIGN CERTIFICATE

Program Code: 1C12955

The certificate in costume/makeup design is designed to prepare the student for occupational competency in the field of costume/makeup design for theater.

To earn a certificate, the required courses as listed with a minimum grade of “C.” At least 50% of all course work must be completed at Cypress College.

| Required courses are listed in suggested sequence: | | Units |
|---|--|--------------|
| Course # | Title | |
| THEA 145 C | Fundamentals of Costume Design | 3 |
| ART 182 C | Beginning Drawing or | 3 |
| ART 185 C | Beginning Life Drawing | (3) |
| THEA 147 C | Stage Makeup | 3 |
| THEA 151 C | Stage Crew III — Costume/Makeup | 1–2 |
| And an additional 2–3 units from the following: | | Units |
| THEA 247 C | Prosthetic Makeup | 3 |
| THEA 149 C | Stage Crew I — Running or | 1–2 |
| THEA 150 C | Stage Crew II — Production Preparation or | (1)–(2) |
| THEA 152 C | Stage Crew IV — House/Box Office | (1)–(2) |
| Total Units Required | | 12–14 |

LIGHTING/AUDIO DESIGN CERTIFICATE

Program Code: 1C12956

This certificate in lighting/audio design is designed to prepare the student in occupational competency in lighting and sound design for theater.

To earn a certificate, the required courses must be completed as listed with a minimum grade of “C.” At least 50% of all course work must be completed at Cypress College.

| Required courses are listed in suggested sequence: | | Units |
|---|--|--------------|
| Course # | Title | |
| MUS 124 C | Recording Studio I or | 3 |
| THEA 142 C | Theater Sound and Recording | (2) |
| THEA 144 C | Lighting Design Fundamentals | 3 |
| THEA 140 C | Introduction to Theater Design | 3 |
| THEA 143 C | Stagecraft or | 3 |
| THEA 146 C | Scene Painting | (3) |
| THEA 149 C | Stage Crew I — Running or | 1–2 |
| THEA 150 C | Stage Crew II — Production Preparation | (1)–(2) |
| Total Units Required | | 12–14 |

MUSICAL THEATER PERFORMANCE CERTIFICATE

Program Code: 1C35020

This program is designed to prepare the student for performance competency in the field of Musical Theater. The Musical Theater Certificate requires a total of 20–22 units, 17 units of which are in required courses and as listed with a minimum grade of “C”. At least 50% of all course work must be completed at Cypress College.

| Required courses are listed in suggested sequence: | | Units |
|---|---------------------------------------|--------------|
| THEA 120 C | Acting I | 3 |
| THEA 126 C | Musical Theater Techniques I | 3 |
| THEA 127 C | Musical Theater Techniques II | 3 |
| THEA 132 C | Musical Theater Performance I or | 2–3 |
| THEA 135 C | Musical Theater Performance II or | (2–3) |
| THEA 232 C | Musical Theater Performance III or | (2–3) |
| THEA 233 C | Musical Theater Performance IV | (2–3) |
| THEA 226 C | Musical Theater Techniques III | 3 |
| THEA 227 C | Musical Theater Techniques IV | 3 |
| Select 3 to 4 units from the following: | | Units |
| DANC 105 C | Ballet I | 2 |
| DANC 106 C | Ballet II | 2 |
| DANC 111 C | Jazz Dance I | 2 |
| DANC 112 C | Jazz Dance II | 2 |
| DANC 113 C | Tap Dance I | 1 |
| DANC 114 C | Tap Dance II | 1 |
| Total Units Required | | 20–22 |

TECHNICAL THEATER CERTIFICATE

Program Code: 1C12962

The Technical Theater Certificate is designed to prepare the student for occupational competency in the field of technical theater.

To earn a certificate, the required courses as listed with a minimum grade of "C." At least 50% of all course work must be completed at Cypress College.

Required courses are listed in suggested sequence:

| Course # | Title | Units |
|------------|--|--------------|
| THEA 100 C | Introduction to the Theater | 3 |
| | or | |
| THEA 101 C | Play Analysis | (3) |
| THEA 140 C | Introduction to Theater Design | 3 |
| THEA 143 C | Stagecraft | 3 |
| THEA 146 C | Scene Painting | 3 |
| THEA 149 C | Stage Crew I — Running | 1–2 |
| | or | |
| THEA 150 C | Stage Crew II — Production Preparation | (1)–(2) |
| | Total Units Required | 13–14 |

THEATER ARTS TRANSFER PROGRAM

Students should consult a counselor or www.assist.org for lower division major requirements for most California public universities. (See the Standard Definitions section of the catalog for a description of ASSIST.) Students transferring to an independent college/university should consult the catalog of the individual school and a counselor for lower division major requirements.

Theater Arts (THEA)

THEA 100 C Introduction to the Theater 3 Units

Term hours: 54 lecture. This course is designed for those who wish to explore the arts with special attention given to a survey of all the contributing elements. The course prepares the student for other course offerings in the theater curriculum. Pass/No Pass/Letter Grade Option. Admission to theater performance not to exceed \$50.00. (UC/CSU, AA GE, CSU GE, IGETC, C-ID: THTR 111)

THEA 101 C Play Analysis 3 Units

Advisory: Eligibility for ENGL 100 C.

Term hours: 54 lecture. A basic approach to the analysis of a play script, intended to provide theater students with the tools necessary to understand the literary text of a play, its structure and its application to work in performance, design and critical/historical studies. Admission to theater performances not to exceed \$50.00. (UC/CSU, AA GE, C-ID: THTR 114)

THEA 102 C World Theater History I 3 Units

Advisory: Eligibility for ENGL 100 C.

Term hours: 54 lecture. The student will investigate the influence of differing cultures, traditions, and technologies on the development of the theater as a social institution through comparative study of plays, historical events, and the theatrical environment. Theater practice from its origins through the mid 18th century will be studied. Plays are read for analysis of structure, plot, character and historical relevance. Admission to theater performances not to exceed \$50.00. (UC/CSU, AA GE, CSU GE, IGETC, C-ID: THTR 113)

THEA 107 C Diversity in American Theater 3 Units

Advisory: Eligibility for ENGL 100 C.

Term hours: 54 lecture. America's ethnic, racial and cultural heritages and the struggles for social equality that have shaped American theater, literature and performance will be explored. Duplicate credit not given for THEA 107HC. Admission to theater performance not to exceed \$50.00. (UC Credit Limitation/CSU, AA GE, CSU GE, IGETC, CUL DIV)

THEA 107HC Honors Diversity in American Theater 3 Units

Advisory: Eligibility for ENGL 100 C.

Term hours: 54 lecture. This course is an enhanced study of America's ethnic, racial and cultural heritages and the struggles for social equality that have shaped American theater, literature and performance. Duplicate credit not given for THEA 107 C. Admission to theater performance not to exceed \$50.00. (UC Credit Limitation/CSU, AA GE, CSU GE, IGETC, CUL DIV)

THEA 108 C Stage and Screenwriting 3 Units

Advisory: Eligibility for ENGL 100 C.

Term hours: 54 lecture. Beginning playwrights and screenwriters discover the basic craft of creating scripts for stage, screen and television. The class will concentrate on student's current work and illustrations will be drawn from contemporary plays and screenplays. Admission to theater performances not to exceed \$50.00. (CSU, AA GE)

THEA 120 C Acting I 3 Units

Term hours: 36 lecture and 72 laboratory. Acting methods of the modern actor will be studied. Students will use craft preparations which will enable them to bring emotional and behavioral truth to the roles they create. Exercises in relaxation, sensory awareness, emotional freedom and the creation of truthful behavior will be practiced. Admission to theater performances not to exceed \$50.00. Pass/No Pass/Letter Grade Option. (UC/CSU, AA GE, CSU GE, C-ID: THTR 151)

THEA 121 C Dynamic Movement for the Stage 2 Units

Term hours: 18 lecture and 54 laboratory. Students learn the art of physical communication. Students will discover and explore structured physical play, unarmed stage combat and stimulus response exercises. Basic anatomy as it relates to motion and communication will be examined. This class is designed for actors and all students. Admission to theater performances not to exceed \$50.00. (UC/CSU, CSU GE)

THEA 124 C Acting II 3 Units

Prerequisite: THEA 120 C or audition.

Advisory: Concurrent enrollment or completion of THEA 121 C or THEA 129 C.

Term hours: 36 lecture and 72 laboratory. Actors will proceed to a more advanced exploration and mastery of the basic craft of acting. Actors will learn specific skills for preparing a role and for creating and experiencing the imaginary realities that fulfill a script. Admission to theater performance not to exceed \$50.00. (UC/CSU, C-ID: THTR 152)

THEA 125 C Acting III 3 Units

Prerequisite: THEA 124 C with a minimum grade of "C".

Term hours: 36 lecture and 72 laboratory. Actors will proceed to an advanced exploration and mastery of the basic craft of acting with an emphasis on fulfilling the demands characterization. Admission to theater performances not to exceed \$50.00. (UC/CSU)

THEA 126 C Musical Theater Techniques I 3 Units

Term hours: 36 lecture and 72 laboratory. Students will investigate performance techniques of musical theater as they relate to the onstage performer. Established musical theater repertoire will be covered and performance in a workshop setting of musical theater literature is required. Admission to theater performances not to exceed \$50.00. (UC/CSU, AA GE, CSU GE)

THEA 127 C Musical Theater Techniques II 3 Units*Prerequisite: Audition.**Advisory: THEA 126 C.*

Term hours: 36 lecture and 72 laboratory. Students will explore the synthesis of singing and movement as it applies to musical theater performance and auditions. This course is designed for the performance oriented student. Admission to theater performances not to exceed \$50.00. (UC/CSU)

THEA 128 C Acting for the Camera 2 Units

Term hours: 18 lecture and 54 laboratory. Students will master the fundamental craft of acting for television and feature film. Guidelines for solving the specific demands the camera makes on the actor will be stressed. Pass/No Pass/Letter Grade Option. Admission to Theater Performances not to exceed \$50.00. (UC/CSU)

THEA 129 C Voice and Diction 3 Units

Term hours: 54 lecture. This is a course in the study of and exercise in voice production and articulation with the goal of producing Standard American speech. Special attention is given to diction for actors, classroom teachers and students with minor speech defects. Stress is placed on individual exercises designed to give conscious control of speech functions. Admission to theater performances not to exceed \$50.00. Pass/No Pass/Letter Grade Option. (UC/CSU, AA GE, CSU GE)

THEA 130 C Acting Workshop 2–3 Units*Prerequisite: Audition.*

Term hours: 108–162 laboratory TBA. This performance laboratory will emphasize the application of the principles and the craft of creative acting. Faculty and theater students will initiate and prepare performance projects for an invited audience and theater festival competition. May be taken for credit 3 times. (UC/CSU)

THEA 132 C Musical Theater Performance I 2 to 3 Units*Prerequisite: Audition.**Corequisite: THEA 149 C or THEA 150 C or THEA 151 C or THEA 152 C.*

Term hours: 126-162 laboratory TBA depending on units attempted. The students will participate in the preparation of a musical production through acting, singing, dancing and/or instrumental accompaniment. Performers will make use of production elements and performance techniques. (UC/CSU, AA GE, CSU GE, C-ID: THTR 191)

THEA 133 C Rehearsal Performance I 2 to 3 Units*Prerequisite: Audition.**Corequisite: THEA 149 C or THEA 150 C or THEA 151 C or THEA 152 C.*

Term hours: 108-162 laboratory TBA. This course teaches the practical application of acting and production techniques, i.e., acting, stage managing, backstage operations. Students participate in the rehearsal and performance of a public production occurring in the Theater Arts Department. (UC/CSU, AA GE, CSU GE, C-ID: THTR 191)

THEA 134 C Auditions for Theater/Film 1 Unit*Prerequisite: Audition.*

Term hours: 18 lecture. Theater students will create and then perform audition presentations that demonstrate their proficiency in the fundamental skills of acting and auditioning. (CSU)

THEA 135 C Musical Theater Performance II 2 to 3 Units*Prerequisite: Audition.**Corequisite: THEA 149 C or THEA 150 C or THEA 151 C or THEA 152 C.*

Term hours: 126-162 laboratory TBA depending on units attempted. The students will participate in the development of a musical theater production from rehearsal to public performance. They will synthesize singing, dancing and acting techniques into a cohesive performance. (UC/CSU)

THEA 136 C Rehearsal Performance II 2 to 3 Units*Prerequisite: Audition.**Corequisite: THEA 149 C or THEA 150 C or THEA 151 C or THEA 152 C.*

Term hours: 108-162 laboratory TBA This performance course concentrates on training students in the intermediate skills required of performing and preparing a public performance for the Theater Department. Production support in the areas of stage management, backstage operations, sound, makeup, costumes and house management are also taught. (UC/CSU)

THEA 140 C Introduction to Theater Design 3 Units

Term hours: 36 lecture and 54 laboratory. Students will be offered a survey of scenery, lighting, sound, costumes, makeup, properties, theatrical equipment, and construction techniques through demonstration, and laboratory experience. Information is applicable to all formal theatrical applications. Admission to theater performance not to exceed \$50.00. (UC/CSU, C-ID: THTR 172)

THEA 142 C Theater Sound and Recording 2 Units

Term hours: 18 lecture and 54 laboratory. The student will be involved in recording studio procedure and equipment selection and use for theater. The course covers the technical as well as the artistic use of sound recording for theater. Emphasis will be placed on the practical use of audio equipment. Admission to theater performances will not exceed \$50. (CSU)

THEA 143 C Stagecraft 3 Units

Term hours: 36 lecture and 54 laboratory. This course explores the planning and execution of scenic elements for the stage with an emphasis on design, construction and methods of shifting scenery. Admission to theater performances will not exceed \$50.00. \$25 Materials Fee - Payable at Registration. (UC/CSU, C-ID: THTR 171)

THEA 144 C Lighting Design Fundamentals 3 Units

Term hours: 36 lecture and 54 laboratory. This course involves the study and execution of stage lighting with emphasis on equipment, control, color, and their relationship to design. Admission to theater performances not to exceed \$50. (UC/CSU, C-ID: THTR 173)

THEA 145 C Fundamentals of Costume Design 3 Units

Term hours: 36 lecture and 54 laboratory. Students will study costume history, design, and basic construction techniques as an introduction to basic theatrical costuming. Fabrics and their various uses will be investigated. Admission to theater performances will not exceed \$50. (UC/CSU, CSU GE, C-ID: THTR 174)

THEA 146 C Scene Painting 3 Units

Term hours: 36 lecture and 54 laboratory. Various methods of painting theatrical scenery will be explored. Tools to be used will include brush, roller, sponges. Students will duplicate stucco, masonry, woodgrain, foliage, wall-paper, lettering drapery, and architectural detail on rigid scenery. Admission to the theater performances will not exceed \$50.00. \$30.00 Materials Fee - Payable at Registration. (UC/CSU)

THEA 147 C Stage Makeup 3 Units

Term hours: 36 lecture and 54 laboratory. Students will receive instruction and practice in a lecture/laboratory setting in all phases of makeup specifically designed for theatrical use. Admission to theater performances not to exceed \$50. (UC/CSU, C-ID: THTR 175)

THEA 148 C Production Techniques I .5 to 3 Units*Prerequisite: Audition.*

Term hours: 32-192 laboratory hours depending on units attempted. This is an open entry/open exit class for students to obtain performance experience in theater. It is open to student performers to fill in vacancies for a theater department production. Concurrent enrollment in THEA 148 C through THEA 152 C is not allowed. Open Entry/Open Exit. (CSU)

THEA 149 C Stage Crew I - Running 1 to 2 Units

Term hours: 54-108 laboratory TBA. This course offers students practical experience as members of a running crew for public theater performances. Students will fulfill crewing assignments during final rehearsals and performances for theater productions during the semester. (UC/CSU, AA GE, CSU GE, C-ID: THTR 192)

THEA 150 C Stage Crew II - Production Preparation 1 to 2 Units

Term hours: 54-108 laboratory TBA. This course offers students practical experience as members of a construction, lighting, sound crew for public theater performances. Students will gain practical experience in the construction of scenery, properties, hanging/focusing lights and preparation of sound equipment for theatrical productions during the semester. (UC/CSU, C-ID: THTR 192)

THEA 151 C Stage Crew III – Costume-Makeup 1 to 2 Units

Term hours: 54-110 laboratory TBA. This course offers students practical experience as members of a costume and makeup crew for public theater performances. Students will gain practical experience in the construction of costumes and application of stage makeup. (UC/CSU, C-ID: THTR 192)

THEA 152 C Stage Crew IV – House-Box Office 1 to 2 Units

Term hours: 54-108 laboratory TBA. This course offers students practical experience as members of a house and box office crew for public theater performances. Students will gain practical experience in house management and box office during performances. (UC/CSU, C-ID: THTR 192)

THEA 155 C Production Techniques II .5 to 3 Units

Term hours: 36-216 laboratory TBA depending on units attempted. This is an open entry/open exit class for students to obtain production experience in theater. It is open to student crew members to fill in vacancies for a theater department production. Concurrent enrollment in THEA 148 C through THEA 152 C is not allowed. (CSU)

THEA 156 C Production Techniques III .5 to 3 Units

Term hours: 27-162 laboratory. This is an open entry/open exit class for students to obtain production preparation experience in the theater. (CSU)

THEA 220 C Acting IV 3 Units

Prerequisite: THEA 125 C with a minimum grade of "C".

Advisory: THEA 121 C or THEA 129 C.

Term hours: 36 lecture and 72 laboratory. The actor will develop and practice the fundamental skills required to perform dramatic literature that varies from classical texts to contemporary plays. Admission to theater performances not to exceed \$50.00. (UC/CSU)

THEA 225 C Directing for the Theater 3 Units

Advisory: ENGL 060 C.

Term hours: 36 lecture and 72 laboratory. The director's purpose in the theater will be examined through current craft approaches and through a historical context. Practical experience in directing through class projects will be stressed. Admission to theater performances not to exceed \$50.00. (UC/CSU)

THEA 226 C Musical Theater Techniques III 3 Units

Prerequisite: Audition.

Advisory: THEA 127 C.

Term hours: 36 lecture and 72 laboratory. The musical theater actor will examine various styles of musical theater as they apply to both solo and scene work. The research and performance of musical theater literature that varies from legitimate standard to pop contemporary styles will be required. Admission to theater performances not to exceed \$50.00. (UC/CSU)

THEA 227 C Musical Theater Techniques IV 3 Units

Prerequisite: THEA 226 C or audition.

Term hours: 36 lecture and 72 laboratory. The musical theater actor will analyze the script and score of a piece of musical theater repertoire and develop a performance using advanced musical theater techniques. Admission to theater performances not to exceed \$50.00. (UC/CSU)

THEA 228 C Advanced Acting for the Camera 2 Units

Prerequisite: THEA 128 C or audition.

Term hours: 18 lecture and 54 laboratory. Students will continue their exploration and mastery of craft approaches for television and film acting, including, but not limited to advanced character development and special problems in performance preparation. Admission to theater performances not to exceed \$50.00. Pass/No Pass/Letter Grade Option. (CSU)

THEA 230 C Directing Actors for Film and TV 2 Units

Advisory: Eligibility for ENGL 100 C.

Term hours: 18 lecture and 54 laboratory. Student directors will analyze screenplays and characters for the purpose of directing actors. Emphasis on staging scenes for the camera to elicit the best possible performances from the actors. (UC/CSU)

THEA 232 C Musical Theater Performance III 2 to 3 Units

Prerequisite: Audition.

Corequisite: THEA 149 C or THEA 150 C or THEA 151 C or THEA 152 C.

Term hours: 126-162 laboratory TBA depending on units attempted. The students will prepare a work of musical theater for public performance through play analysis, character analysis, style analysis and rehearsal, using vocal skills, choreographic movement and acting techniques. (CSU)

THEA 233 C Musical Theater Performance IV 2 to 3 Units

Prerequisite: Audition.

Corequisite: THEA 149 C or THEA 150 C or THEA 151 C or THEA 152 C.

Term hours: 108-162 laboratory TBA. The students will prepare and perform a work of musical theater for public performance focusing on script obligations, character relationship, external and internal focus techniques, performance style choices and physical expression character driven action. (UC/CSU)

THEA 234 C Rehearsal Performance III 2 to 3 Units

Prerequisite: Audition.

Corequisite: THEA 149 C or THEA 150 C or THEA 151 C or THEA 152 C.

Term hours: 108-162 laboratory TBA. This is a performance oriented course that concentrates on training students in the methodology and advanced skills of ensemble acting during a rehearsal period. Production support in the areas of stage management, backstage operations, sound, makeup, costumes, and house management are also introduced by practical involvement in the unique demands of producing an ensemble performance. (UC/CSU)

THEA 235 C Experimental Theater 2 Units

Term hours: 108 laboratory. This course consists of short-term projects in theater production (selection to be made by the department). Projects may include student-directed, one act plays, touring shows and improvisational theater shows. (UC/CSU)

THEA 236 C Summer Theater Workshop I 1 to 2 Units

Prerequisite: Audition.

Term hours: 54-108 laboratory. This performance laboratory will introduce students to the basic skills of new play development and innovative performance works. Faculty and theater students will evaluate, create and prepare performance projects for an invited audience. (UC/CSU)

THEA 237 C Summer Theater Workshop II 1 to 2 Units*Prerequisite: Audition.*

Term hours: 54-108 laboratory. This performance laboratory will invest students with the intermediate skills of new play development and innovative performance works. Faculty and theater students will evaluate, create and prepare performance projects for an invited audience. Pass No/Pass Letter Grade Option. (UC/CSU)

THEA 238 C Rehearsal and Performance IV 2 to 3 Units*Prerequisite: Audition.**Corequisite: THEA 149 C or THEA 150 C or THEA 151 C or THEA 152 C.*

Term hours: 108-162 laboratory TBA. Students will explore and develop further the advanced skills required for performance goals. Production skills in the areas of stage management, backstage operations, sound, makeup, costumes, and house management are acquired by practical involvement through performances. (UC/CSU)

THEA 247 C Prosthetic Makeup 3 Units*Prerequisite: THEA 147 C.*

Term hours: 36 lecture and 54 laboratory. Students will explore the techniques of special effects makeup. The basic construction of foam latex appliances, wounds and burns, bald cap application, and ventilated hair construction will be utilized. \$150 Materials Fee - Payable at Registration. (CSU)

THEA 298 C Theater Arts Seminar .5 to 12 Units*Prerequisite: May be required.**Corequisite: May be required.**Advisory: May be required.*

Term hours: 0-216 lecture and/or 864 laboratory depending on units attempted. Various classes may be offered from semester to semester which are designed to meet the interests and needs of the students. May be taken for credit 1-4 times. Pass/No Pass or Pass/No Pass/Letter Grade Option or Standard Letter Grade. Fees may be required-Payable at Registration or for admission to theater performances. (UC Credit Limitation/CSU)

THEA 299 C Theater Arts-Independent Study .5 to 2 Units*Prerequisite: Approved Independent Study Learning Contract.*

Term hours: 8-36 lecture depending on units attempted. This course is designed for students who wish to increase their knowledge of theater and/or theatrical practices through individual study or research. May be taken for credit 4 times. (UC Credit Limitation/CSU)

Travel Careers — See Aviation and Travel Careers (ATC)

Undeclared or Undecided

TRANSFER PROGRAM

Students should consult a counselor or www.assist.org for lower division major requirements for most California public universities. (See the Standard Definitions section of the catalog for a description of ASSIST.) Students transferring to an independent college/university should consult the catalog of the individual school and a counselor for lower division major requirements.

Faculty

North Orange County Community College District

1830 W. Romneya
Anaheim, California 92801
(714) 578-8400

Board of Trustees

Stephen T. Blount

Jeffrey P. Brown

Barbara Dunsheath

Ed Lopez

Molly McClanahan

Ryan Bent

Jacqueline Rodarte

Cypress College Student Trustee

Daniel Sebastian

Fullerton College Student Trustee

Andrew Washington

District Administration

Chancellor

Dr. Cheryl Marshall

Vice Chancellor, Educational Services
and Technology

Dr. Cherry Li-Bugg

Vice Chancellor, Finance and Facilities

Fred Williams

Vice Chancellor, Human Resources

Irma Ramos

Provost, North Orange Continuing Education

Valentina Purtell

Cypress College Administration and Organizational Structure

PRESIDENT

JoAnna Schilling

Executive Vice President

Dr. Santanu Bandyopadhyay

Vice President

Vacant

Executive Director, Foundation and
Community Relations

Vacant

Director, Institutional Research and
Planning

Philip Dykstra

President

Executive Vice President

Administrative Services

Foundation and Community Relations

Institutional Research and Planning

Professional Development

Campus Diversity

Executive Vice President

**Educational Programs and
Student Support Services —**

Business/CIS — Henry Hua

Regional Consortium

Petitions

Career Technical Education —

Distance Education/Online

Economic Development

Grants

Title V

Perkins

Counseling and Student Development/ Admissions and Records — Dr. Paul R. de Dios, Dean

Registrar — David Booze

Adult Re-Entry Program

Articulation

Assessment Center

Career Planning Center

College Success Factors Index (CSA)

Counseling Center

Disability Support Services (DSS) — Celeste Phelps, Director

International Students Program — Yongmi Han, Manager

Legacy Program (Counseling Component)

Matriculation

Puente Program

Student Discipline

Student Equity

Student Success and Support Program

Teacher Preparation Program (Counseling Component)

Transfer Center

Fine Arts — Dr. Katy Realista, Dean

Instructional Development

Patrons of the Arts

Health Sciences —

Health Services — Marla McBride, Director
 Nursing — Darlene Fishman, Director

**Kinesiology and Athletics Director —
 Dr. Richard Rams, Dean**

Athletic Director — Bill Pinkham

Language Arts — Eldon Young, Dean

Forensics
 Legacy Program

Library and Learning Resources — Dr. Treisa Cassens, Dean

Distance Education
 Language Lab/Open Computer Lab
 Learning Center
 Tutoring Center

Science, Engineering and Math — Dr. Richard Fee, Dean

Basic Skills
 Learning Communities
 STEM

Social Sciences —

Honors
 Teacher Preparation Program Coordination

Student Support Services — Dr. Richard Rams, Dean

Ambassadorship
 Associated Students
 CalWORKS
 CARE/Extended Opportunity Programs and Services —
 Financial Aid — Chinh Pham, Director
 Guardian Scholars
 High School Outreach
 Student Activities — David Okawa, Director
 Veterans Resource Center

Vice President —

Administrative Services — Vacant

**Academic Computing — Vacant
 Systems Technology Services**

Media Services
 Teaching Learning Center
 Telecommunications

Bookstore — Follett Higher Education Group

Business and Auxiliary Services

Campus Accounting — Dao Do, Manager

Campus Safety — Roland Esquivel, Interim

Switchboard
 Emergency Preparedness

Facilities Use and Rentals

Financial and Business Support Services

Grant Support Services

Personnel

Physical Plant and Facilities — Albert Miranda, Director

Maintenance and Operations — Bob Riffle, Manager
 Mailroom

Faculty and Staff Service Center Coordination

**Foundation and Community Relations —
 Executive Director**

Vacant

Director, Campus Communications — Marc Posner

Division Structure

**Division Dean, Business and Computer
 Information Systems**

Henry Hua

Department Coordinator,
 Accounting

Ann Sheridan-Solis

Department Coordinator,
 Court Reporting

Carolee Freer

Department Coordinator,
 Computer Information Systems

Susana Jianto

Department Coordinator,
 Management/Marketing/Sales/Retailing

Kathleen Pinckard

Department Coordinator, Computer Information
 Systems/Office Administration

Donna Woo

**Interim Division Dean,
 Career Technical Education**

Kathleen Reiland

Department Coordinator,
 Aviation and Travel Careers

Kathleen Reiland

Department Coordinator,
 Air Conditioning/Refrigeration

Doug Sallade

Department Coordinator,
 Automotive Collision

Larry Ramos

Department Coordinator,
 Automotive Technology

Luciano Orozco

Department Coordinator,
 Energy and Sustainable Technology

Doug Sallade

Department Coordinator,
 Hospitality, Restaurant, Culinary Arts

Jeremy Peters
 Lisa Clark

**Division Dean, Counseling and Student Development/
Admissions and Records**

| | |
|--|--|
| Registrar | Dr. Paul R. de Dios |
| Director, Disability Support Services (DSS) | David Booze |
| Director, Transfer Center and Counselor of Honors Program | Celeste Phelps |
| Director, Student Success and Support Program | Penny Gabourie |
| Manager, International Students Program | Vacant |
| Articulation Officer | Yongmi Han |
| Coordinator, Career Center | Vacant |
| Department Coordinator, Counseling | Deann Burch |
| Counselor, Athletics/Kinesiology | Kelly Carter |
| Counselor, Business and Computer Information Systems | Dana Bedard |
| Counselor, Career Technical Education | Robert Grantham |
| Counselor, Career Planning/ Adult Re-Entry Program | Jane Jepson |
| Counselor, Disability Support Services (DSS) | Sarah Coburn |
| Counselor, Fine Arts and International Students Program | Marisa Lehmeier Deborah Michelle |
| Counselor, Fine Arts | Renay Laguana-Ferinac |
| Counselor, Health Science | Renee Ssensalo |
| Counselor, Language Arts, Social Science and Teacher Preparation Program | Kelly Carter Doreen Villaseñor Denise Vo |
| Counselor, Language Arts, Social Science and Puente Program | Daniel Pelletier |
| Counselor, Language Arts and Social Science | Dr. Therese Mosqueda-Ponce |
| Counselor, Science/Engineering/Mathematics and Legacy Program | Daniel Pelletier |
| Counselor, Transfer Center | Deidre Porter |
| Counselor, Veteran Affairs | Yolanda Duenas |
| Learning Disabilities Specialist, DSS | Robert Grantham |
| | Dr. Dawn Decker |
| Division Dean, Fine Arts | Dr. Katy Realista |
| Department Coordinator, Art | Molly Schulp |
| Department Coordinator, Communications/Journalism | Vacant |
| Department Coordinator, Dance | Maha Afra |
| Department Coordinator, Media Arts Design | Ian Holmes |

| | |
|-------------------------------------|---------------|
| Department Coordinator, Music | Gary Gopar |
| Department Coordinator, Photography | Cliff Lester |
| Department Coordinator, Theater | Mark Majarian |

Interim Division Dean, Health Science

| | |
|---|---------------------------------|
| Director of Nursing | Rebecca Gomez |
| Department Coordinator, Dental Assisting | Darlene Fishman |
| Department Coordinator, Dental Hygiene | Elizabeth Pacheco |
| Department Coordinator, Diagnostic Medical Sonography | Kendra Velasco |
| Department Coordinator, Health Information Technology | Lynn Mitts |
| Department Coordinator, Mortuary Science | Vacant |
| Department Coordinator, Psychiatric Technology | Jolena Grande |
| Department Coordinator, Radiologic Technology | Jaime Ramos |
| Department Co-Coordinators, Nursing | Lynn Mitts |
| | Denise Bernstein Sally McNay |

Division Dean, Kinesiology

| | |
|------------------------|------------------|
| Athletic Director | Dr. Richard Rams |
| Department Coordinator | Bill Pinkham |
| | Margaret Mohr |

Division Dean, Language Arts

| | |
|--|------------------|
| Department Coordinator, English | Eldon Young |
| Department Coordinator, English as a Second Language | Linda Borla |
| Department Coordinator, Foreign Language | Alison Robertson |
| Department Coordinator, English/Reading | Alex Herrera |
| Department Coordinator, Communication Studies | Sarah Jones |
| | Liana Koepfel |

Division Dean, Library and Learning Resource Center

| | |
|--------------------------------|-----------------|
| Library Department Coordinator | Treisa Cassens |
| Library Services Coordinator | Billy Pashaie |
| Learning Center Coordinator | James Carrocino |
| | Allyssa Rocha |

**Division Dean, Science/Engineering/
Mathematics**

| | |
|---|-------------------|
| | Richard Fee |
| Department Coordinator, Biology | Stephanie Spooner |
| Department Coordinator, Chemistry | Lenore Landis |
| Department Coordinator, Mathematics | Cindy Shrout |
| Department Coordinator, Physical Science, Computer Science | Ron Armale |

Interim Division Dean, Social Sciences

| | |
|---|-----------------|
| | Lisa Gaetje |
| Director of Human Services | Gary Zager |
| Department Coordinator, Anthropology | Becky Floyd |
| Department Coordinator, Economics | Fola Odebunmi |
| Department Coordinator, Ethnic Studies | Daniel Lind |
| Department Coordinator, Geography | Armando Mendoza |
| Department Coordinator, History | David Halahmy |
| Department Coordinator, Human Services | Gary Zager |
| Department Coordinator, Philosophy and Religious Studies | Willis Heusser |
| Department Coordinator, Political Science | Gloria Badal |
| Department Coordinator, Psychology | Brandy Young |
| Department Coordinator, Sociology | Regina Rhymes |

Instructional Divisions

Divisional faculty members and counselors have offices conveniently located adjacent to classrooms. In addition, each building provides lounge and study areas to encourage student participation in divisional activities.

Business and Computer Information Systems

BUSINESS EDUCATION BUILDING

The Business Division and Instructor offices are located on the second floor adjacent to Parking Lot 1. The building has three floors of instructional classrooms as well as a second floor Computer Information Systems Lab. Lobby areas on the first and second floors provide study areas and WiFi access.

PROGRAMS

Business Transfer Degrees, Business Vocational Certificates, Associate Degrees, Accounting, Computer Information Systems, Court Reporting, Marketing, and Management

COUNSELOR

Grantham, Robert

DIVISION DEAN

Hua, Henry

Division Office Manager: Stephanie Acosta (714) 484-7212

Administrative Assistant: Arcy Dropulic (714) 484-7211

Instructional Assistant: Theresa Tracy (714) 484-7215

Instructional Assistant: Ayman Gadalla (714) 484-7214

Instructional Assistant: Khanh Cao (714) 484-7216

FACULTY

Clarke, Bret
Freer, Carolee
Izadi, Behzad
Jianto, Susana
Moody, Alireza
Molnar, Peter
McKnight, Richard
Pelachik, Patricia
Pinckard, Kathleen
Sheridan-Solis, Ann
Woo, Donna
Wu, Penn

Career Technical Education

PROGRAMS

Administration of Justice, Air Conditioning and Refrigeration, Aviation and Travel Careers, Automotive Collision Repair, Automotive Technology, Commercial Pilot; Aviation — Management, Homeland Security, Hotel, Restaurant, Culinary Arts, Industrial Arts — Energy and Sustainable Technology

COUNSELOR

Jepson, Jane

DIVISION DEAN

Vacant

Division Office Manager: Cindy Cao (714) 484-7231

ACR Lab Clerk/AT Technician: Lidia Coman (714) 484-7250/7245

AT Shop Coordinator: Louis Krebs (714) 484-7245

HRC Lab Technician: Tracey Heine (714) 808-4554

FACULTY

Alexander, John
Bacarella, Russell
Beard, Michael
Clark, Lisa
Hock, Richard
Kelley, Paul
Klyde, Michael
Orozco, Luciano
Peters, Jeremy
Ramos, Larry
Reiland, Kathleen

Rosati, Stephanie
Sallade, Douglas
Snook, Dan
Urquidi, Carlos
Valdez, Edilberto

Fine Arts

PROGRAMS

Art, Dance, Journalism, Media Arts Design, Music, Photography,
Theater Arts

COUNSELORS

Laguana-Ferinac, Renay
Ssensalo, Renee

INTERIM, DIVISION DEAN

Realista, Dr. Katy

Division Office Manager: Anna Marie Novisoff (714) 484-7139

Administrative Assistant/Art: Nadia Wallace (714) 484-7134

Instructional Assistant/Art: Kirk Pickler (714) 484-7035

Administrative Assistant/Dance: Lynette Young (714) 484-7201

Administrative Assistant/Media Arts Design: Nadia Wallace
(714) 484-7134

Administrative Assistant/Music: Diane Villegas (714) 484-7140

Instructional Assistant/Photography: Grace Supharmak
(714) 484-7244

Administrative Assistant/Theater: Lynette Young (714) 484-7201

Theater Production Coordinator/Theater: Chuck Rogers
(714) 484-7203

Theater Technician/Theater: Steve Banneck (714) 484-7204

FACULTY

Afra, Maha
Anguelov, Katalin
Giardina, Edward
Gopar, Gary
Holmes, Ian
Hormel, James
Landry, Erin
Lester, Clifford
Majarian, Mark
McMillan, Marcus
Owen-Driggs, Janet
Paiement, Paul
Patti, Joyce
Schulps, Molly
Hurdle, Terra

Health Science

PROGRAMS

Registered Dental Assistant
Dental Hygiene
Diagnostic Medical Sonography
Diagnostic Medical Sonography Certificate
Health Information Technology
Mortuary Science
Registered Nursing
Career Mobility Nursing
Psychiatric Technology
Radiologic Technology
Imaging Technologist Assistant Certificate

COUNSELORS

Carter, Kelly
Vo, Denise
Villaseñor, Doreen

DIVISION DEAN

Vacant

Division Office Manager: Jennifer Franklin (714) 484-7284

Administrative Assistant: Dawn Sontag (714) 484-7283

Administrative Assistant/Evaluator: Vacant (714) 484-7270

Administrative Assistant/Dental Clinic: Jodie Thomas (714) 484-7298

Lab Technician/Mortuary Science: Lori Hopper (714) 484-7280

Clerical Assistant/Mortuary Science: Cathy Wells (714) 484-7278

DIRECTOR OF NURSING

Fishman, Darlene

FACULTY

Bower, Glenn
Boyce, Jane
Corrales, Nancy
de la Cruz, Damon
Faraci, Michael
Franks, Joseph
Frianeza, Michael
Frumkin, Sally
Gomez, Rebecca
Grande, Jolena
Johannsen, Christina
Kim, Shinah
Kruse, Kathleen
Larez, Jennie
Lawrence, Roberta
Marquardt, Marcus
McCament, David
McNay, Sally
Medina-Bernstein, Denise
Mitts, Lynn
Ortega, Ryan
Pacheco, Elizabeth
Putman, Elizabeth
Ramos, Jaime
Siegel, Barry

Silva, Joel
 Smith, Susan
 Swytak, Judy
 Tira, Diana
 Velasco, Kendra
 Valencia, Wendy
 Walker, Jane
 Williams, Marredda

Kinesiology **(formerly Physical Education)**

PROGRAMS

Kinesiology, Public Health, Recreation

COUNSELOR

Bedard, Dana

DIVISION DEAN

Rams, Richard

Division Office Manager: Pamela Brackman (714) 484-7353

Athletic Equipment Coordinator: Manual Verdugo (714) 484-7377

Athletic Trainer: Scott Tucker (714) 484-7381

Eligibility Secretary: Yvonne Cota (714) 484-7351

Laundry Attendant: Teresa Sestito (714) 484-7376

Sports Information Representative: Wes McCurtis (714) 484-7356

FACULTY

Alhadeff, Andrew
 Beidler, Larry
 Benito, Jeff
 Grote, Silvie
 Hutting, Anthony
 Mohr, Margaret
 Pickler, Brad
 Pinkham, Bill
 Welliver, Nancy

Language Arts

PROGRAMS

English, English/Reading, ESL (English for Non-Native Speakers),
 Foreign Language, Communication Studies

COUNSELORS

Lam, Mymy
 Mosqueda-Ponce, Therese
 Pelletier, Daniel

DIVISION DEAN

Young, Eldon

Division Office Manager: Sharon Cox (714) 484-7170

Administrative Assistant: Rhonda Kraft (714) 484-7169

FACULTY

Baver, Jill
 Borla, Linda
 Brydges, Michael
 Campbell, Justin
 Dickey, Cherie
 Diep, Christie
 Herman, Jenelle
 Forman, Mary K.
 Fujimoto, Janet
 Gutierrez, Ruth
 Herrera, E. Alex
 House, Joshua
 Jones, Sarah
 Kashi, Barbara
 Kaufman, Bret
 Keel, Lawrence J.
 Klein, Susan
 Koeppel, Liana
 Lambros, John
 Letcher, Annette
 McAlister, Kathleen
 Melodia, Joseph
 Nabahani, Melanie
 Page, Jennifer
 Palmer, Kendyl
 Payne, John
 Puma, Jessica
 Robertson, Alison
 Rosenberg, Stuart
 Simmons, Samantha
 Sonne, Kathryn
 Takahashi, K. Mariye
 Talwar, Ambika
 Tran, Stephanie
 Vescial, Keith
 Wada, Kathryn
 Wahbe, Randa

Library and Learning Resources

PROGRAMS

Library, Learning and Academic Resources

COUNSELORS

Lawson, Velia
 Mosqueda-Ponce, Therese
 Pelletier, Daniel

DIVISION DEAN

Cassens, Treisa

FACULTY

Boyd, Angela
 Doman, Monica
 Palmer, Leslie
 Pashaie, Billy
 Peacock, Joyce

Science/Engineering/Mathematics

PROGRAMS

Astronomy, Biological Sciences/Life Sciences, Biology, Chemistry, Computer Science, Physical Science, Engineering — Chemical, Civil, Electrical, Mechanical, Engineering Technology, Geology, Mathematics, Physical Therapy, Physics, Pre-Dentistry, Pre-Medicine, Pre-Optometry, Pre-Pharmacy, Pre-Veterinary, Science Teacher Preparation

COUNSELOR

Porter, Deidre

DIVISION DEAN

Fee, Richard

Division Office Manager: Susan Davis (714) 484-7153

Administrative Assistant: Julie Angevine (714) 484-7153

Biology Lab Tech: Robyn Udell (714) 484-7163

Biology/Chemistry Lab Tech: David Dang (714) 484-7000 ext 48602

Chemistry Lab Tech: Sara Escarrega (714) 484-7161

Physical Sciences Lab Tech: Vacant (714) 484-7166

FACULTY

Armale, Ron
Cadilli, Jolina
Castle, Victoria
Castro, Alma
Chiplunkar, Sujata
Coopman, Jennifer
De Roo, Robin
Domke, Kirk
Draganov, Torri
Eckenrode, Adam
Frey, Michael
Gill, David
Gober, Joel
Gotoh, Allison
Hall, Tony
Hill, Garet
Ledesma, Nicole
Lee, Eunju
Landis, Lenore
Mintzer, Alex
Morvan, Laurie
Nguyen, Kelly
Nguyen, Sheila
Nusbaum, David
Ogoshi, Fumio
Paek, Sylvia
Palmisano, Michelle
Plett, Christina
Rajab, Adel
Roby, Scott
Saleh, Massoud
Sanchez, Tony
Sato, Dee
Shin, Gary
Shrout, Cindy
Spooner, Stephanie

Subramaniam, Brinda
Tomooka, Craig
Tran, Hoa
Ward, Amy

Social Sciences

PROGRAMS

Addiction Studies, Anthropology, Conflict Resolution, Criminal Justice, Economics, Ethnic Studies, Family Studies, Geographic Information Systems, Geography, Gerontology, History, Human Services Generalist, Philosophy and Religious Studies, Political Science, Psychology, Sociology, Victimology

COUNSELORS

Lam, Mymy
Mosqueda-Ponce, Therese
Pelletier, Daniel

DIVISION DEAN

Vacant

Division Office Manager: Nancy Pound (714) 484-7185

Administrative Assistant: Rhonda Kraft (714) 484-7185

FACULTY

Adams, Virgil III
Badal, Gloria
Bladh, Eric
Cavin, Robert “Greg”
Curiel, Larry
Dedic, James
deDios, Angela
Estrada, Steven
Flores, Michael
Floyd, Becky
Goralski, Craig
Halahmy, David
Heusser, Willis
Johnson, Susan
Lewis, Carol
Lind, Daniel
Martinez, Randall
Mathews, Eapen Peter
Mendoza, Armando
Odebunmi, Fola
Rhymes, Regina
Sandoval, Carlos
Seiling, Bryan
Sidhu, Parwinder
Tapia, James
Thibodeau, Jason
Young, Brandy
Zager, Gary

2017–2018 Administration and Faculty Accomplishments

Adams, Virgil III — *Human Services*

B.A., California State University, San Bernardino
M.A., Azusa Pacific University
M.S., Walden University

Alexander, John — *Automotive Technology*

B.A., California State University, Long Beach

Alhadeff, Andrew — *Kinesiology*

B.A., University of Redlands
M.S., Azusa Pacific University

Armale, Ron — *Physics/Astronomy*

B.S., California State Polytechnic University, Pomona
M.S., Ph.D., University of California, Irvine

Bacarella, Russ — *Automotive Technology*

B.S., Weber State University

Badal, Gloria — *Political Science*

A.A., Cypress College
B.A., M.A., California State University, Fullerton

Bandyopadhyay, Santanu — *Executive Vice-President*

B.Sc., Calcutta University, India
M.B.A., Ph.D., Ohio University

Baver, Jill — *English as a Second Language*

B.A., Taylor University
M.A., TESOL Seattle Pacific University

Beard, Michael — *Automotive Technology*

A.S., Cypress College

Bedard, Dana — *Counselor/Student Development*

B.A., University of California, San Diego
M.S., California State University, Long Beach

Beidler, Larry E. — *Kinesiology*

A.A., Santa Ana College
B.A., California State University, Long Beach
M.Ed., Azusa Pacific University

Benito, Jeffrey C. — *Kinesiology*

A.A., Riverside City College
B.S., University of La Verne
M.S., California Baptist University

Bernstein, Denise — *Nursing*

ADN, Cypress College
B.S.N., M.S.N., University of Phoenix

Bladh, Eric — *Geography*

B.A., M.A., California State University, Los Angeles

Booze, David Mosely — *Registrar, Admissions and Records*

B.A., M.S., S.U.N.Y., Buffalo

Borla, Linda — *English*

B.A., M.A., California State University, Sacramento

Bower, Glenn — *Mortuary Science*

ASMS, Cypress College
B.Tech Funeral Service Administration, S.U.N.Y. Canton
B.A., California Lutheran University, Thousand Oaks
M.S., National University, San Diego

Boyce, Jane C. — *Psychiatric Technology*

B.S.N., California State University, Fullerton
M.S., California State University, Long Beach
Adult Nurse Practitioner

Boyd, Angela — *Library*

B.A., University of California, Santa Cruz
M.L.I.S., San Jose State University

Brydges, Michael — *Communication Studies*

A.A., Mt. San Antonio College
B.A., M.A., California State University, Los Angeles

Cadilli, Jolina — *Mathematics*

M.S., California State University, Long Beach

Carter, Kelly — *Counseling/Student Development*

A.A., Ricks College
B.S., Brigham Young University
M.A., California State University, Fresno

Cassens, Treisa — *Library*

B.A., University of California, San Diego
M.L.I.S., University of California, Los Angeles
Ed.D., University of Southern California

Castle, Victoria — *Geology*

A.A., Saddleback Community College, Mission Viejo
B.S., California State University, Los Angeles
M.B.A., Pepperdine University, Malibu

Castro, Alma — *Mathematics*

B.S., California State University, Bakersfield
M.S., California State University, Long Beach

Cavin, Robert Greg — *Philosophy and Religious Studies*

B.A., University of Southern California
M.A., Fuller Theological Seminary
B.A., M.A., Ph.D., University of California, Irvine

Cherney, Julia — *Dental Hygiene*

R.D.H., B.S., University of California, Riverside
M.S., Kaplan University

Chiplunkar, Sujata — *Biology*

B.S., South Gujarat University, India
M.S., Ph.D., The Maharaja Sayajirao University of Baroda, India

Clark, Lisa — *Hospitality Management*

B.A., California State University, Sacramento
M.S.Ed., California State University, Fullerton

Coburn, Sarah — *Counseling/Student Development/Career Center*

B.A., San Diego State University
M.S., California State University, Northridge

Coopman, Jennifer — *Mathematics*

B.S., University of California, Los Angeles
M.S., California State University, Long Beach

Corrales, Nancy — *Diagnostic Medical Sonography*

A.S., Long Beach City College
B.S., Autonomous University of Baja California

Curiel, Larry — *Sociology*

B.A., M.A., California State University, Fullerton

de Dios, Angela — *Psychology*

B.A., University of Southern California
M.A., Ph.D., Clark University

de Dios, Paul — *Division Dean, Counseling, Student Development, and Admissions and Records*

A.A., Cerritos College
B.A., University of California, Irvine
M.S., Ed.D., California State University, Long Beach

Dedic, James — *Sociology/Social Work*

B.A., M.A., California State University, Fullerton
M.S.W., University of Southern California

De Roo, Robin — *Chemistry*

B.A., M.A., California State University, Fullerton

Dickey, Cherie — *English/Reading*

B.A., M.A., Ed.D., California State University, Long Beach

Diep, Christie Rossier — *English*

A.A., Golden West
B.A., M.A., California State University, Fullerton

Doman, Monica Maldonado — *Library*

B.A., M.L.S., University of California, Los Angeles

Domke, Kirk — *Geology*

B.S., University of Wisconsin, Madison
M.S., University of Wisconsin, Milwaukee
Ph.D., University of Southern California, Los Angeles

Draganov, Torri — *Chemistry*

A.A., Saddleback College
B.S., University of California, San Diego
M.S., University of California, Irvine

Driggs, Janet Owen — *Art*

B.F.A., Canterbury College of Art, UK
M.F.A., University of Southern California
M.A., Art Center College of Design

Duenas, Yolanda — *Counseling/Student Development/Transfer Center*

A.A., Golden West College
B.A., California State University, Long Beach
M.A., M.S., University of La Verne

Eckenrode, Adam — *Mathematics*

B.S., M.S., California State Polytechnic University, Pomona

Estrada, Steven — *Ethnic Studies*

B.A., M.A., California State University, Fullerton

Faraci, Michael — *Nursing*

B.A., Central Connecticut State University
M.S.N., California State University, Los Angeles
D.N.P., Western University of Health Sciences

Fee, Richard — *Division Dean, Science, Engineering and Mathematics*

B.A., Colorado College
Ph.D., Pennsylvania State University

Fishman, Darlene C. — *Director, Nursing*

B.S.N., Virginia Commonwealth University
M.S.N., California State University, Los Angeles
Ed.D., California State University, Fullerton

Flores, Michael C. — *History*

B.A., California State University, Fullerton
M.A., California State University, Los Angeles
Ed.D., Argosy University, Orange County

Floyd, Becky D. — *Anthropology*

B.A., California State University, Fullerton
M.A., University of Montana

Forman, Mary K. — *English*

B.A., University of Rhode Island
M.F.A., University of Massachusetts

Franks, Joseph — *Psychiatric Technology*

A.A., Cypress College
B.A., M.A., California State University, Fullerton

Freer, Carolee — *Court Reporting*

A.A., Cerritos College
B.A., M.B.A., California State University, Fullerton
Certified Reporting Instructor, NCRA

Frey, Michael — *Astronomy, Physics*

B.S., University of Arizona
M.S., California State University, Long Beach

Frianeza, Michael — *Radiologic Technology*

A.S., Cypress College
B.S.R.S., Midwestern State University
M.S., Texas A&M University
Ed.S., Nova Southeastern University
Ph.D., University of Hertfordshire-UK

Frumkin, Sally — *Nursing*

A.S., East Los Angeles College
B.S.N., California State University, Los Angeles
M.S.N., California State University, Long Beach

Fujimoto, Janet — *English*

B.A., M.A., California State University, Fresno

Gabourie, Lillian (Penny) — *Honors Counselor/
Transfer Center Director*

B.A., California State University, Fullerton
M.S., University of La Verne

Giardina, Edward — *Fine Arts*

B.F.A., California State University, Fullerton
M.F.A., Vermont College — Norwich University

Gill, David — *Biology*

B.A., M.A., University of California, Santa Barbara
Ph.D., Cornell University

Gober, Joel R. — *Biology*

B.A., M.S., Ph.D., Southern Illinois University

Gomez, Rebecca R. — *Health Information Technology*

B.S., University of California, Los Angeles
M.S., California State University, Long Beach
M.A., University of San Francisco

Gopar, Gary — *Music*

B.A., M.M., California State University, Long Beach

Goralski, Craig T. — *Anthropology*

A.A., Goldenwest College
B.A., M.A., California State University, Fullerton
Ph.D., Pennsylvania State University

Gotoh, Allison — *Chemistry*

B.S., M.S., Ph.D., University of California, Irvine

Grande, Jolena — *Mortuary Science*

A.S., Cypress College
B.S., University of Central Oklahoma
M.F.S., M.S., National University

Grantham, Robert — *Counselor/Student Development*

A.A., Fullerton College
B.A., University of California, Irvine
M.S.W., California State University, Long Beach

Grote, Silvie — *Kinesiology*

A.A., Orange Coast College
B.S., Chapman University
M.S., California State University, Fullerton
M.A., California State University, Long Beach
Ph.D., Loma Linda University

Gutierrez, Ruth — *English/Reading*

B.A., California State University, Fullerton
M.A., Walden University

Halahmy, David G. — *History*

B.A., University of California, Los Angeles
M.A., California State University, Northridge

Hall, Anthony — *Physics*

B.S., Case Western Reserve University
M.S., Ph.D., University of California, Los Angeles

Han, Yongmi — *Manager, ISP*

B.A., University of California, Irvine
M.A., University of California, Santa Barbara

Herman, Jenelle — *English as a Second Language*

B.S., California Baptist University
M.A., Azusa Pacific University

Herrera, E. Alexis — *Spanish*

B.A., M.A., University of Utah

Heusser, Willis — *Philosophy and Religious Studies*

A.A., Pierce College
B.A., University of California, Los Angeles
M.A., University of Rochester, New York

Hill, Gareth — *Mathematics*

B.S., Biola University
M.A., California State University, Fullerton

Hock, Richard — *Air Conditioning/Refrigeration*

B.S., State University of New York, Fredonia, N.Y.
M.B.A., University of Phoenix

Holmes, Ian — *Media Arts Design*

B.F.A., Art Center College of Design, Pasadena

Hormel, James — *Theater Arts*

B.A., University of the Pacific, Stockton
M.F.A., University of California, Irvine

Hurdle, Terra — *Music*

B.A., Pacific University, Oregon
M.A., Western Oregon University

Hutting, Anthony — *Kinesiology*

B.A., California State University, Fullerton
M.S., Azusa Pacific University

Izadi, Behzad — *Computer Information Systems*

B.S., University of Washington, Seattle
M.S., University of California, Davis
Ph.D., Colorado State University, Fort Collins

Jepson, Jane C. — *Counseling/Student Development*

B.A., Towson State University
M.S., California State University, Long Beach
Ph.D., California Institute of Integral Studies

Jianto, Susana — *Computer Information Systems*

B.S., University of Kansas
M.Ed., University of Texas at Austin

Johannsen, Tina — *Psych Tech*

B.S., M.S., California State University, Fullerton

Johnson, Susan — *Psychology*

B.A., University of North Carolina — Greensboro
M.A., Pepperdine University

Jones, Sarah — *English/Reading*

B.A., M.S., California State University, Fullerton

Kashi, Barbara — *English/Reading*

B.Ed., Seattle University
M.S., California State University, Fullerton

Keel, Lawrence J. — *English*

B.A., University of Southern California
M.P.W., M.A., Ph.D., University of Southern California

Kelley, Paul — *Career Technical Education*

A.S., Automotive GM ASE, Hudson Valley Community College
B.S., Technology, S.U.N.Y. Empire State College

Klein, Susan — *English/Reading*

B.A., Westmont College, Santa Barbara
M.A., California State University, Los Angeles
M.A., California State University, Long Beach

Klyde, Michael — *Automotive Technology*

B.A., M.A., California State University, Long Beach

Koeppel, Liana — *Communication Studies*

B.A., San Diego State University
M.A., California State University, Northridge
Ph.D., University of Southern California

Kruse, Kathleen — *Nursing*

B.A., Occidental College
B.S.N., Washington State University
M.S.N., California State University, Los Angeles

Laguana-Ferinac, Renay — *Counseling/Student Development*

B.A., California State University, Dominguez Hills
M.A., Pepperdine University

Lam, Mymy — *Counseling/Student Development*

B.A., University of California, Irvine
M.S., California State University, Long Beach

Lambros, John — *Communication Studies*

B.A., M.A., California State University, Long Beach

Landis, Lenore — *Chemistry*

B.S., California State University, Long Beach
M.S., University of California, Los Angeles

Landry, Erin — *Dance*

B.F.A., California Institute of the Arts
M.F.A., University of California, Irvine

Larez, Jennie — *Health Information Technology*

A.S., Cypress College

Lawrence, Roberta — *Dental Hygiene*

R.D.H., Cypress College
R.D.H.A.P., West Los Angeles College
B.A., California State University, Fullerton
M.S., Higher Education, Kaplan University

Ledesma, Nicole — *Mathematics*

A.A., Saddleback College
B.A., M.A., California State University, Fullerton

Lee, Eunju — *Mathematics*

B.S., M.S., California State University, Long Beach

Lehmeier, Marisa — *Counseling/Student Development/DSS*

A.A., Cerritos College
B.S., California State University, Fullerton
M.A., Loyola Marymount University

Lester, Clifford — *Photography*

B.A., Brooks Institute of Photography

Letcher, Annette — *English/Reading*

B.A., Concordia University, St. Paul, Minnesota
M.S., Ed.D., California State University, Fullerton

Lewis, Carol P. — *History*

B.A., M.A., University of California, Riverside

Lind, Daniel Joseph — *Ethnic Studies*

B.A., Bowdoin College
M.P.S., Cornell University
M.A., Claremont Graduate University

Marquardt, Marcus — *Psych Tech*

A.A., A.S., Citrus College
B.A., M.A., California State University, Los Angeles

McAlister, Kathleen — *English*

B.A., University of California, Los Angeles
M.A., Brown University
C. Phil., University of California, Los Angeles

McCament, Dave — *Mortuary Science*

A.S., Cypress College
B.A., M.F.S., National University

McKnight, Richard — *Computer Information Systems*

B.S., California State University, Long Beach
M.A., Chapman University

McNay, Sally — *Nursing*

A.D.N., Cypress College
B.S.N., M.S.N., California State University, Dominguez Hills
E.C.D., Grant MacEwan College

Majarian, Mark — *Theater Arts*

B.A., Pomona College
M.F.A., University of California, Los Angeles

Martinez, Randall — *Psychology*

B.A., M.A., San Jose State University
Ph.D., University of Utah

Mathews, Eapen Peter — *Political Science*

B.A., M.A., University of North Texas

Melodia, Joseph — *Language Arts*

A.A., Orange Coast College

B.A., California State University, Long Beach

M.A., M.F.A., Chapman University

Mendoza, Armando — *Geography*

B.A., University of Northern Colorado

M.S., Texas A&M University

Michelle, Deborah — *Counseling/**Student Development/DSS*

B.A., M.S., San Diego State University

Miller, Jeanne K., C.P.A. — *Accounting*

A.A., Pasadena City College

B.S., California State University, Los Angeles

M.B.A., California State Polytechnic University, Pomona

Mintzer, Alex — *Biology*

B.S., University of California, Irvine

Ph.D., University of Michigan

Mitts, T. Lynn — *Radiologic Technology*

B.S.R.T., Midwestern State University

M.A., California State University, Long Beach

Moady, Alireza — *Computer Information Systems*

B.A., Pars College

M.S., Florida Institute of Technology

Ph.D., United States International University

Mohr, Margaret — *Kinesiology*

B.A., M.A., California State University, Long Beach

Morvan, Laurie — *Mathematics*

B.S., University of Illinois at Urbana-Champaign

M.S., California State University, Long Beach

Mosqueda-Ponce, Therese L. — *Counseling/Student Development*

B.S., California State University, Fullerton

M.S., California State University, Los Angeles

Ph.D., United States International University

Nabahani, Melanie — *English*

B.A., M.A., California State University, Fullerton

Nguyen, Kelly — *Mathematics*

B.S., University of California, Irvine

M.A., California State University, Fullerton

Nguyen, Sheila — *Chemistry*

B.S., University of California, Riverside

M.S., University of Saint Joseph, West Hartford, CT

M.Ed., National University, San Diego

Nusbaum, David — *Mathematics*

B.S., M.Ed., University of California, Los Angeles

M.S., University of California, Irvine

Odebunmi, Fola — *Economics*

B.A., Chapman University

M.A., California State University, Fullerton

Ogoshi, Fumio — *Biology*

B.A., University of San Diego

Ph.D., University of California, Irvine

Orozco, Luciano M. — *Automotive Technology*

B.A., California State University, Los Angeles

Pacheco, Elizabeth — *Dental Assisting*

A.A., Riverside Community College

B.V.E., M.Ed., California State University, San Bernardino

Paek, Sylvia — *Mathematics*

A.A., El Camino College

B.S., M.S., University of California, Irvine

Paiement, Paul — *Art*

B.F.A., Minneapolis College of Art and Design

M.F.A., University of Southern California

Palmer, Kendyl C. — *English*

B.A., California State University, Los Angeles

M.A., University of Sussex, England

Palmer, Leslie — *Librarian*

B.A., California State University, Fullerton

M.L.S., San Jose State University

Palmisano, Michelle — *Biology*

B.E., Vanderbilt University

M.S., Ph.D., University of California, San Diego

Palomares, Eva — *EOPS/Student Support Services*

A.A., Rio Hondo College

B.A., University of California, San Diego

M.S., University of La Verne

Pashaie, Billy — *Librarian*

B.A., M.L.I.S., University of California, Los Angeles

M.A., California State University, Los Angeles

Patti, Joyce — *Art*

B.A., University of California, Los Angeles

M.F.A., Yale University

Payne, John — *Language Arts*

B.A., M.A., M.F.A., California State University, Long Beach

Peacock, Joyce — *Librarian*

B.A., California State University, Long Beach

M.L.S., University of Illinois, Urbana-Champaign

Pelachik, Patricia A. — *Computer Information Systems/**Office Administration*

B.B.A., Cleveland State University

M.B.E., Eastern Michigan University

M.S., Nova University

Pelletier, Daniel — *Counseling/Student Development*

A.A., Saddleback College
 B.A., California State University, Fullerton
 M.A., Azusa Pacific University

Peters, Jeremy — *Culinary Arts*

A.S., Orange Coast College

Phelps, Celeste — *M.Ed. Director, DSS*

A.A., Long Beach City College
 B.A., California State University, Long Beach
 M.Ed., Northern Arizona University

Pickler, Brad A. — *Kinesiology*

A.A., Cypress College
 B.S., California State University, Fullerton
 M.S., California Lutheran College

Pinckard, Kathleen Troy — *Business/Management*

B.S.L., J.D., Western State University

Pinkham, Bill — *Kinesiology*

B.S., California State University, Fullerton
 M.A., United States International University

Plett, Christina — *Mathematics*

A.A., Fullerton College
 B.A., California State University, Long Beach
 M.S., University of California, Irvine

Porter, Deidre M. — *Counseling/Student Development*

B.A., University of California, Irvine
 M.A., Loyola Marymount University
 Ed.D., University of Southern California

Puma, Jessica — *Spanish*

B.A., University of California, Los Angeles
 M.A., University of California, Irvine

Putman, Elizabeth — *Nursing*

A.A., L.A. Harbor College
 B.S.N., M.S.N., California State University, Long Beach
 N.P., Harbor-UCLA

Rajab, Adel — *Biology*

B.S., M.S., California State University, Long Beach
 Ed.D., University of California, Irvine and
 University of California, Los Angeles

Ramos, Jaime — *Psych Tech*

MSN/Ed., RN, University of Phoenix

Ramos, Larry — *Auto Collision Repair*

A.A., Cypress College

Rams, Richard — *Division Dean,
Student Support Services and Kinesiology*

B.A., University of California, Riverside
 M.S.Ed., University of Kansas
 Ed.D., University of California, Irvine

Realista, Katy — *Division Dean, Interim*

Fine Arts
 B.A., Ed.D., California State University, Fullerton
 M.A., San Diego State University

Reiland, Kathleen — *Aviation and Travel Careers*

B.S., University of San Francisco
 M.A., California State University, San Marcos

Reza, Alan — *EOPS/Student Support Services*

A.A., Fullerton College
 B.A., San Diego State University
 M.S., National University

Rhymes, Regina — *Sociology*

B.A., M.A., California State University, Fullerton
 M.S., University of Phoenix

Robertson, Alison — *English as a Second Language*

B.A., California State University, Fullerton
 MTESL, Arizona State University

Roby, Scott — *Mathematics*

A.A., Modesto College
 B.A., California State University, Stanislaus
 M.A., Ph.D., University of California, Riverside

Rosati, Stephanie — *Hotel, Restaurant, Culinary Arts*

A.A., Citrus College

Rosenberg, Stuart — *English*

B.A., California State University, Long Beach
 M.P.W., University of Southern California

Saleh, Massoud — *Engineering/Physics*

B.S., Amirkabir University
 M.S., California State University, Northridge
 Ph.D., California State University, Long Beach

Sallade, Douglas — *Air Conditioning/Refrigeration*

M.A., California State University, Long Beach

Sanchez-Duran, José Antonio — *Biology*

B.A., California State University, Fullerton
 Ph.D., University of Missouri, Columbia

Sandoval, Carlos — *Psychology*

B.A., California State University, Fullerton
 M.A., Pepperdine University

Sato, Dee Ann — *Biology*

B.S., University of Washington
 M.S., University of California, Davis

Schulps, Molly — *Fine Arts*

M.F.A., California State University, Northridge

Seiling, Bryan — *History*

B.A., M.A., University of Southern California

Sheridan-Solis, Ann, C.P.A. — *Accounting*

A.A., Mount San Antonio College
B.S., California State Polytechnic University, Pomona

Shin, Gary — *Biology*

B.S., B.A., University of California, Berkeley
Ph.D., University of California, Los Angeles

Shrout, Cynthia — *Mathematics*

B.S., Phillips University
M.A., California State University, Fullerton

Sidhu, Parwinder — *Economics*

B.A., M.S., Ph.D., Guru Nanak Dev University, India

Siegel, Barry — *Radiologic Technology*

A.A.S., St. Louis Community College
B.A., B.S., M.Ed., University of Missouri

Simmons, Samantha — *English as a Second Language*

B.A., California State University, Fullerton
M.A., California State University, San Diego

Smith, Susan D. — *Nursing*

A.S.N., Pasadena City College
B.S.N., University of Phoenix
M.S.N./Ed., University of Phoenix

Snook, Dan — *Automotive Collision*

A.A., Chaffey College

Sonne, Kathryn T. — *English*

B.A., M.A., Brigham Young University

Spooner, Stephanie — *Biology*

B.S., M.S., California State University, Long Beach

Ssensalo, Renee — *Counseling/Student Development*

B.A., M.S., California State University, Long Beach

Subramaniam, Brinda — *Physics/Engineering*

B.S., M.S., Ph.D., Jiwaji University, India

Swytak, Judy — *Nursing*

A.A., Golden West College
B.S.N., M.S.N., California State University, Dominguez Hills

Takahashi, K. Mariye — *Japanese*

B.A., M.A., University of California, Los Angeles

Talwar, Ambika — *English/Comparative Literature*

B.A., Lady Shri Ram College, Delhi University
M.A., Delhi University, Delhi, India
M.A., California State University, Fullerton

Tapia, James — *Human Services*

B.A., Southern California College
M.A., National University

Thibodeau, Jason — *Philosophy and Religious Studies*

B.A., University of California, Berkeley
Ph.D., University of California, San Diego

Tira, Diana — *Health Science*

A.S., R.D.H., Cypress College
R.D.H.A.P., University of Pacific, San Francisco
B.S.D.H., M.D.H., Loma Linda University

Tomooka, Craig — *Chemistry*

B.S., University of California, Irvine
M.S., Ph.D., California Institute of Technology

Tran, Hoa

M.A., B.A., California State University, Fullerton

Tran, Stephanie — *English*

B.A., University of San Diego
M.F.A., Northwestern University

Urquidi, Carlos, P.E. — *Air Conditioning/Refrigeration*

B.S., California State University, Los Angeles
M.S., California State University, Fullerton

Valdez, Edilberto — *Aviation and Travel Careers*

B.S., Embry-Riddle Aeronautical University, Daytona Beach

Valencia, Wendy — *Nursing*

B.S.N., California State University, Dominguez Hills
M.S.N., University of California, Los Angeles

Vescial, Keith — *English/Reading*

B.A., Loma Linda University
B.A., University of Maryland
M.A., University of Indiana
M.A., University of California, Riverside
M.S., University of Alabama, Birmingham

Villaseñor, C. Doreen — *Counseling/Student Development*

A.A., Fullerton College
B.A., California State University, Fullerton
M.A., California State University, Dominguez Hills

Velasco, Kendra — *Dental Hygiene*

R.D.H., B.S., University of Southern California
M.S., Kaplan University

Vo, Denise — *Counseling/Student Development*

B.A., California State University, Long Beach
M.S., National University

Wada, Kathryn — *English as a Second Language*

B.A., University of California, Irvine
M.A., California State University, Long Beach

Wahbe, Randa B. — *Comparative Literature*

B.A., California State University, Los Angeles
M.A., California State University, Fullerton
Ed.D., Argosy University, Orange

Walker, Jane — *Nursing*

ASN, Santa Ana College
B.A., California State University, Fullerton
M.S.N., California State University, Dominguez Hills

Ward, Amy — *Mathematics*

A.A., Santa Ana College

B.A., M.A., California State University, Fullerton

Welliver, Nancy — *Kinesiology*

B.A., California State University, Long Beach

M.Ed., Azusa Pacific University

Williams, Marredda — *Nursing*

B.S.N., California State University, Los Angeles

M.S.N., California State University, Dominguez Hills

Woo, Donna L. — *Computer Information Systems/
Office Administration*

B.A., M.A., Michigan State University

Wu, Penn — *Computer Information Systems*

Ph.D., Nova Southeastern University

Young, Brandy — *Psychology*

B.A., University of California, Los Angeles

M.A., Ph.D., University of California, Irvine

Young, Eldon — *Division Dean, Language Arts*

B.A., University of California, Los Angeles

M.A., Loyola Marymount University

Zager, Gary — *Human Services*

B.A., M.S., California State University, Fullerton

Professors Emeritus

| | |
|----------------------------|---|
| Allison, Minnie | Mathematics |
| Alvarez, Kathleen | Nursing |
| Ashburn, Shirley | Nursing |
| Atkinson, Thomas W. | Business |
| Austin, Peggy | Librarian |
| Axline, Donna | Business/Math |
| Azen, Robert | Biology |
| Baca, J. Anthony | Physical Education |
| Baldwin, William | Computer Science |
| Bales, Elbert N. | Counseling |
| Ball, Sheridan | Music |
| Barrier, Catherine | Library |
| Beamer, Edwin | Counseling |
| Bedard, Donald | Vice President, Student Personnel Services |
| Berger, Ellen | Art |
| Beyer, George | Music |
| Bilyeu, Dean | Counseling |
| Blanchard, Donald | Automotive Technology |
| Blillie, Jeannie | Psychiatric Technology |
| Bloom, Barbara | Health Science |
| Boettger, Kathleen | Mortuary Science |
| Boettger, Robert | Mortuary Science |
| Bottiaux, Paul | Kinesiology |
| Boyle, Joseph | Political Science/History |
| Broadwell, Ronald B. | Music |
| Brockert, Carolyn | Psychiatric Technology |
| Brown, Dana | Health Information and Radiologic Technology |
| Brown, Kaleta | Dean, Fine Arts/Theater Arts |
| Bruce, Kay | Dean, Library and Instructional Development |
| Bruce, Malcolm | Computer Science |
| Buchanan, John | History |
| Buckbee, Thomas | Engineering Technology |
| Burchfield, Jerry | Photography |
| Bush, Robert | Aeronautics |
| Byrnes, Nancy R. | Dental Hygiene; Vice President, Educational Support and Planning |
| Calhoun, Fred | Counseling |
| Campagna, Anna K. | Nursing Education |
| Campbell, Mary | Business |
| Campellone, Bonna | Division Dean, Health Science |
| Canova, Lawrence | Psychology |
| Capsuto, Michael | Accounting |
| Carlisle, Eugene | History |
| Centobene, William | Chemistry |
| Chamness, Robert | Reading/English |
| Chen, Helen | Chemistry |
| Chi, Hong | ESL |
| Chin, Penny | Nursing |
| Claffey, William J. | Business |
| Clay, Joan | Nursing |
| Cooney, Neill | Philosophy |
| Cooper, Thomas | Counseling/Articulation |
| Cooper, Will | Sociology |
| Coppess, Alice | Nursing Education |
| Cross, Robert | Dental Technology |
| Dainko, John | Auto Collision Repair |
| Daniels, Joan | English |
| Davis, Mary Kay | Dental Assisting |
| Dawson, Shirley | Dental Assisting |
| DeCoro, Helena | Music |
| Dellinger, Pat | Computer Information Systems |
| DeMallac, Gail | French/ESL |
| Deutsch, Nancy | English/Reading |
| Doak, Leslie | Geography |
| Dodson, Laurie | Health Information Technology |
| Dorn, Marian | Physical Education |
| Drake, David | Photography |
| Dudley, Nelson | Art |
| Easton, Sharon | Counseling/Student Development |
| Edwards, Cyril | Sociology |
| England, Jean | Counseling/Student Development |
| Felos, Charlene | Art |
| Florentine, Rose Ann | Nursing |
| Flynn, Russell | Oceanography |
| Fouste, E. Bonita | Anthropology |
| Fraese, Jayne | English |
| Fraese, Ronald W. | Social Science |
| Franklin, Kathleen | English/Reading |
| Freiman, Wayne | Air Conditioning/Refrigeration |
| Fried, Gladys | Nursing Education |
| Friess, Donna | Communication Studies |
| Gallo, Joseph | Music |
| Ganer, Patricia | Communication Studies |
| Geddes, Patricia | English |
| Gee, Carol | Nursing Education |
| Gibby, Cheryl | Mathematics |
| Gifford, Charles F. | Aviation |
| Glattly, Marilyn J. | Dance; Dean, Fine Arts |
| Gold, Stephen | Mathematics |
| Gorno, Ric | Marketing/Management/Finance |
| Green, Carol | Dental Hygiene |
| Green, Keith | Geology |
| Greico, Laura | Radiology |
| Gross, Katherine G. | Art |
| Hall, Richard | Biology |
| Hannon, Andrea | Division Dean, Health Science |
| Hardy, Robert | Art |
| Harkrider, James R. | Biology |

| | | | |
|-------------------------------|---|-----------------------------|--------------------------------|
| Harmon, Roger..... | English | Maddox, Evelyn..... | Nursing Education |
| Harvey, Carol | Nursing | Magnusson, Robert E. | History |
| Hayes-Williams, Jerrilyn..... | Office Administration | Manis, Armen | English |
| Head, Fred | Computer Information Services | Mao, Chaolin..... | Mathematics |
| Heinze, Betty | English | Masters, Gerald | Psychology |
| Henry, Diane | Dean/Athletic Director Physical Education | Melom, Jane..... | Counseling |
| Herzog, Anna | Nursing | Mercadante, Larry | Physical Education |
| Hucker, Don | Management/Marketing | Mercer, Robert..... | Journalism |
| Hickey, Dennis | Philosophy | Merickel, Karen..... | Biology |
| Higgins, Jeanne | Psychiatric Technology | Metz, Douglas..... | Mortuary Science |
| Hinkson, Kenneth..... | Computer Information Systems | Miller, Jeanne | Accounting |
| Hoffmann, Nena L. | Nursing Education | Miller, Peggy | Psychiatric Technology |
| Ida, Almira | Nursing Education | Mills, Richard..... | Management/Law |
| Isenberger, Janis Cook..... | Physical Education | Moran, Olga..... | Spanish |
| Itnyre, Terry F. | English | Morrison, Joan..... | Nursing Education |
| Jacobs, Michael..... | Division Dean, Fine Arts and SEM | Mottershead, Allen..... | Engineering/Mathematics |
| Jeffer, Marsha..... | English | Myres, Brian | Biology |
| Johnson, Don..... | Physical Education | Nelson, Kristine..... | Counseling/Matriculation |
| Johnson, Michael..... | Media Arts Design | Nelson, William | Accounting |
| Johnson, Rowena | Business | Nordee, Thomas..... | Counseling/Student Development |
| Jones, Anthony | Auto Collision | O'Brien, Noreen | Nursing |
| Jones, Francis L. | Business | O'Brien, Patrick..... | Language Arts |
| Jones, Raymond | Music | Oda, Sam..... | Automotive Service and Repair |
| Kegel, Robert | Management/Marketing | Oliveira, A. Fernando | Spanish/Portuguese |
| Kelly, Henry..... | Nursing Education | Olson, Diana | Nursing |
| Kelly, Patricia | Dental Assisting | Oravetz, Orpha..... | Nursing Education |
| Killen, Brian | Psychology | Ortiz, Louis | Counseling |
| Kishel, Patricia..... | Management/Marketing | Owens, Cynthia..... | Counseling |
| Koike, Judy..... | Librarian | Page, JoAnne M. | Counseling |
| Koerper, Henry | Anthropology | Page, Ruthanna | Hospitality/Travel Careers |
| Kolsky, Gail | Counseling | Paris, Vincent..... | Culinary Arts |
| LaCour, Marshall | Photography | Park, Willis..... | Geography |
| Lawson, Velia..... | Counseling | Payne, Alice | Counseling/Student Development |
| Lewis, Margie | President | Parmenter, Susan..... | Staff Development/English |
| Leyda, Jack | Music | Parmenter, William..... | Dean, Counseling |
| Licari, Charles..... | Reading/English | Pearl, Carl..... | Economics |
| Livsey, Gerry..... | Physical Education | Pearson, Ola Faye | Medical Record Technology |
| Llanos, Kathy | ESL | Pecchia, Leonard T. | Physical Education |
| Long, Jack..... | Business | Petrie, David | Mathematics |
| Lubin, Thomas | Chemistry | Phillips, James..... | Economics |
| Lucostic, James J. | History | Piburn, Elizabeth..... | Nursing |
| Maeda, Mits..... | Sociology | Pickler, Scott..... | Physical Education |
| Majid, Rosalie | Health Information Technology | Pierron, Paul | Accounting |
| Marrs, Barbara..... | Division Dean, Language Arts | Plummer, Cody | Court Reporting |
| Marshall, Barbara | English | Polizzi, Nick | Geography |
| Mattingly, Lynn | Office Administration | Polsky, Diana | Theater Arts |
| McDaniel, Marian..... | Radiologic Technology | Quinliven, Russ..... | Welding |
| McDermott, Rosemary | Counseling | Ransom, Alan..... | Accounting |
| McIntosh, Richard..... | Dean, Language Arts, A&R | Rayl, Nancy..... | English |
| McLeod, Alexander | Social Science | Redman, Ronald P. | History/Spanish |

| | | | |
|---------------------------|-------------------------------|----------------------------|---|
| Reeve, Thomas | Dean, Social Science | Stout, Byron | Mortuary Science |
| Reichart-Sever, Sue | Court Reporting | Svendsen, William..... | Speech |
| Ricci, Paul..... | Philosophy | Taylor, Joann..... | Dental Hygiene |
| Ricker, Marshall | Physics | Tobler, Hank..... | Division Dean, Business and Vo Tech |
| Root, Alfred L. | Mathematics | Trulock, Ron..... | Air Conditioning/Refrigeration |
| Rossier, Roger..... | Counseling | Tyrrell, Don | Counseling |
| Rubino, Kenneth J. | Physical Education | Ueberroth, Jene | English |
| Russell, Barbara..... | Nursing | Van Voorhis, Richard | Physical Education |
| Rydalch, Ina | Dental Hygiene | Vandergrift, Robert..... | Biology |
| Saldana, Jesse | Computer Information Systems | VonSoosten, Ron..... | Computer Information Services |
| Sandore, Russell C. | Marine Technology | Vosbein, Brenda..... | Psychiatric Technology |
| Schaefer, Sandra | Reading | Walston, Wilbur..... | Biology |
| Schick, Charlene..... | Economics | Wassenaar, David | Dean, Business/Computer Information Systems |
| Schiller, Carl | Physical Education | Weber, John..... | English |
| Selga, Max..... | Psychiatric Technology | Welsh, Carol | Dean, Library and Learning Resource Center |
| Sever, Sue | Court Reporting | Whiteside, Dorothy..... | Nursing Education |
| Sherard, Chuck..... | Automotive Technology | Williams, Susan | Nursing |
| Simpson, Altus | Geology | Wilson, Margaret S. | Nursing |
| Siragusa, Chris | Mathematics | Winckler, Janet | Nursing |
| Smith, Glen..... | Automotive Service and Repair | Wood, Arthur..... | Counseling |
| Smith, Larry..... | Mathematics | Wood, Jane..... | ESL |
| Steckler, Albert..... | Counseling | Woodall, Edgar H. | Business |
| Stewart, James L. | Chemistry | Yamada, Mitsuye M. | English |
| Stoltz, Janice | Court Reporting | Zakala, Carol..... | Dental Hygiene |

Quick Guide to Help You

(AREA CODE 714) CAMPUS MAIN NUMBER (714) 484-7000

| SERVICE/OFFICE | LOCATION | TELEPHONE |
|---|---|----------------|
| Admissions and Records | Student Center, 1st Floor | 484-7346 |
| Add and Drop | | 484-7346 |
| Application | | 484-7346 |
| Graduation | | 484-7346 |
| Residency | | 484-7346 |
| Transcripts | | 484-7346 |
| Adult Re-entry | Student Center, 2nd Floor | 484-7120 |
| Assessment Center | Student Center, 2nd Floor | 484-7223 |
| Associated Students | Student Activities Center | 484-7198 |
| Clubs and Organizations, Student Government | | |
| Athletics | Gym II Bldg, 1st Floor, Room 107 | 484-7352 |
| Sports Information | | 484-7356 |
| Bookstore | Bookstore, 1st Floor | 484-7336 |
| Bursar's Office | Student Center | 484-7317 |
| CalWORKs | Cypress College Complex, 2nd Floor, Room 201 | 484-7237 |
| Campus Safety | CCE3, Business Bldg, 1st Floor South | 484-7387 |
| Emergencies, Lost and Found, Parking | | |
| 24/7 Cell Number | | 493-6687 |
| CARE | Cypress College Complex, 2nd Floor, Room 201 | 484-7368 |
| Career Planning Center | Student Center, 2nd Floor | 484-7120 |
| Charger Chronicle | Fine Arts Bldg, 1st Floor | 484-7269 |
| Counseling Service Areas | | |
| Business and CIS | Business Bldg, 2nd Floor | 484-7015 |
| Career Planning/Adult Re-entry | Career Center, Student Center, 2nd Floor | 484-7120 |
| Career Technical Education | Tech Ed I Bldg, 2nd Floor, Room 205 | 484-7015 |
| Charger Experience | Student Center, 2nd Floor | 484-7015 |
| Counseling Center (walk ins) | Student Center, 2nd Floor | 484-7015 |
| Fine Arts | Student Center, 2nd Floor/Fine Arts Bldg, 2nd Floor | 484-7015 |
| Health Science | Tech Ed III (Health Science) Bldg, 2nd Floor | 484-7015 |
| Honors | Student Center, 2nd Floor | 484-7452 |
| International | Fine Arts Bldg, 2nd Floor | 484-7015 |
| Kinesiology | Gym II Bldg, 1st Floor, Room 107B | 484-7015 |
| Language Arts | Student Center, 2nd Floor | 484-7015 |
| Online | Counseling Center, Student Center, 2nd Floor | 484-7015 |
| Probation | Student Center, 1st Floor | 484-7000 x4824 |
| Science, Engineering and Mathematics | Science/Math Bldg, 2nd Floor, Room 222 | 484-7015 |
| Social Sciences | Student Center, 2nd Floor | 484-7015 |
| Transfer | Transfer Center, Student Center, 2nd Floor | 484-7129 |
| Veterans Affairs | Veterans Resource Center | 484-7150 |
| Disability Support Services (DSS) | Cypress College Complex, 1st Floor | 484-7104 |
| Distance Education/Online | | 484-7052 |
| Division Offices | | |
| Business | Business Bldg, 2nd Floor | 484-7211 |
| Career Technical Education (Vocational) | Tech Ed I Bldg, 2nd Floor | 484-7231 |
| Counseling and Student Development | Student Center, 2nd Floor, Room 226 | 484-7334 |
| Fine Arts | Fine Arts Bldg, 2nd Floor | 484-7139 |
| Health Science | Tech Ed III (Health Science) Bldg, 2nd Floor | 484-7283 |
| Kinesiology | Gym II Bldg, 1st Floor, Room 107 | 484-7352 |
| Language Arts | Humanities Bldg, 2nd Floor, Room 240 | 484-7169 |
| Library/Learning Resources | LLRC, 2nd Floor, Room 239 | 484-7070 |
| Science, Engineering and Mathematics | Science/Math Bldg, 2nd Floor, Room 208 | 484-7153 |
| Social Sciences | Humanities Bldg, 2nd Floor, Room 238 | 484-7185 |
| Student Support Services | Cypress College Complex, 2nd Floor, Room 218 | 484-7371 |

Additional information about most of these services can be found in the Student Services section of this schedule.

| SERVICE/OFFICE | LOCATION | TELEPHONE |
|--|---|-----------------|
| English as a Second Language | Humanities Bldg, 2nd Floor, Room 240 | 484-7169 |
| English Success Center | Library/Learning Resource Center, 1st Floor, Room 126 | 484-7000 x48089 |
| EOPS | Cypress College Complex, 2nd Floor, Room 201 | 484-7368 |
| Extended Day Office | Faculty and Staff Service Center (M–Th 4:00 pm–9:00 pm) | 484-7332 |
| | Evening Administrator (M–Th 5:00 pm–9:00 pm) | 484-7333 |
| Facilities Reservations and Rentals | Cypress College Complex, 3rd Floor | 484-7388 |
| Financial Aid | Cypress College Complex, 1st Floor | 484-7114 |
| Food Services — Charger Café | Student Center, 1st Floor | 484-7227 |
| Foundation | Cypress College Complex, 3rd Floor | 484-7126 |
| Scholarships | | |
| Guardian Scholars | Cypress College Complex, 2nd Floor, Room 201 | 484-7368 |
| Health Services | Gym II Bldg, 1st Floor | 484-7361 |
| Honors Program/Service Learning Program | Student Center, 2nd Floor | 484-7452 |
| Instruction Office | Cypress College Complex, 3rd Floor | 484-7329 |
| International Students Program | Student Activities, Bldg 8, 1st Floor | 484-7050 |
| Center for Intercultural Understanding | | |
| I-20 Forms | | |
| Language Lab | Library/Learning Resource Center, 1st Floor | 484-7193 |
| Legacy Program | Humanities Bldg, 2nd Floor, Room 222 | 484-7000 x48595 |
| Library | Library/Learning Resource Center, 2nd Floor | 484-7000 x48381 |
| Learning Resource Center | Library/Learning Resource Center, 1st Floor | 484-7000 x48381 |
| Math/Science Learning Center | Library/Learning Resource Center, 1st Floor, Room 127 | 484-7151 |
| Online Education | | 484-7052 |
| Puente Program | Student Center, 2nd Floor | 484-7015 |
| School of Continuing Education | Continuing Ed., Bldg 14, Room 5 (Off of Lot 4) | 484-7038 |
| Student Services Outreach | Cypress College Complex, 2nd Floor, Room 218 | 484-7371 |
| Student Activities | Student Activities Center | 484-7199 |
| Student Discipline | Student Center, 2nd Floor, Room 226 | 484-7334 |
| Student Success and Support Program (SSSP) | Student Center, 2nd Floor, Room 227 | 484-1097 |
| Study Abroad | Humanities, 2nd Floor, Room 240 | 484-7169 |
| Summer Boost | Student Center, 1st Floor | 484-7000 x48240 |
| Supplemental Instruction | Library/Learning Resource Center, 1st Floor, Room 105 | 484-7322 |
| Teacher Preparation Program | Humanities Bldg, 2nd Floor, Room 238 | 484-7185 |
| TRAC | Cypress College Complex, 2nd Floor, Room 201 | 484-7237 |
| Transfer Center | Student Center, 2nd Floor | 484-7129 |
| Tutorial Center | Library/Learning Resource Center, 1st Floor | 484-7183 |
| Veterans Resource Center | Cypress College Complex, 2nd Floor | 484-7150 |

Additional information about most of these services can be found in the Student Services section of this schedule.

Index

A

| | |
|--|--------|
| AB540 (Residency) | 6 |
| Absences | 11 |
| Academic Achievement Clubs | 39 |
| Academic Calendar 2017–2018 | 3 |
| Academic Distinction | 10 |
| Academic Freedom | 9, 45 |
| Academic Honesty | 10 |
| Academic Honors | 10 |
| Academic Policies | 9 |
| Academic Renewal Policy | 11 |
| Accounting | 76 |
| Administration and Faculty Accomplishments | 317 |
| Administration and Organizational Structure | 310 |
| Administration of Justice | 77 |
| Administrative Procedures | 41 |
| Administrative Procedures 5500 — Standards of Student Conduct and Discipline | 41 |
| Administrative Procedures 5500 — Student Discipline Procedures | 42 |
| Admissions and Records | 32 |
| Admissions Requirements | 6 |
| Adult Re-Entry Program | 32 |
| Advanced Placement (AP), College Level Exam Program (CLEP), International Baccalaureate (IB) | 16 |
| Advanced Placement Credit | 11 |
| Advisory | 70 |
| Air Conditioning and Refrigeration | 78 |
| Anthropology | 82 |
| AP (Advanced Placement) Scores for GE | 17 |
| Appeals and Petitions | 21 |
| Application for an Associate Degree | 52 |
| Application for Certificates | 51 |
| Art | 84 |
| Articulation Statement | 32, 70 |
| Asian Studies | 86 |
| Assessment | 8 |
| Assessment Center | 33 |
| ASSIST | 71 |
| Associate Degree Graduation Requirements for Cypress College | 56 |
| Associate Degrees | 51 |
| Associate Degrees for Transfer | 62, 70 |
| Associated Students Benefits Program | 8 |
| Astronomy | 92 |

| | |
|---------------------------------------|-----|
| Athletic Eligibility | 40 |
| Attendance | 11 |
| Auditing | 12 |
| Automotive Collision Repair | 93 |
| Automotive Technology | 98 |
| Aviation and Travel Careers | 105 |

B

| | |
|---|-----|
| Baccalaureate Degrees | 56 |
| Basic Skills | 21 |
| Biology | 118 |
| Bookstore | 33 |
| Bursar | 33 |
| Business Administration | 121 |
| Business and Computer Information Systems Lab | 26 |

C

| | |
|--|-----|
| California Basic Educational Skills Test (CBEST) | 31 |
| California Subject Examinations for Teachers (CSET) | 31 |
| CalWORKS | 35 |
| Campus Clubs | 39 |
| Campus ID Card | 8 |
| Campus Life | 39 |
| Campus Safety | 33 |
| Career Planning Center | 34 |
| Catalog Rights | 12 |
| Center for Intercultural Understanding (CIU) | 34 |
| Certificate Programs | 48 |
| Challenging Prerequisites, Corequisites, or Other Limitations on Enrollment | 12 |
| Chemistry | 122 |
| Chinese | 124 |
| Class Cancellations | 13 |
| Class Transfers | 13 |
| Classification of Students | 24 |
| Clubs | 39 |
| College Level Examination Program (CLEP) Scores Applied to General Education | 18 |
| Communication Studies | 125 |
| Computer Information Systems | 127 |
| Computer Science | 141 |
| Computing Resources Acceptable Use Policy | 13 |
| Continuing Education Program | 141 |
| Continuing Students | 7 |

Continuous Enrollment 14

Cooperative Agencies Resources for Education (CARE) Programs and Services 35

Core Values of Cypress College 4

Corequisite 71

Corrections to Student Information. 14

Counseling 140 C 34

Counseling and Student Development 34, 141

Counseling/Orientation. 8

Course Double Counting 14

Course Identification Numbering (C-ID) 71

Course Numbering. 14

Course Offerings 26

Course Progression 14

Course Repeat Adjustment. 14

Course Repetition 14

Court Reporting 143

Credit by Examination 15

Credit for Prior Learning. 16

CSU General Education Breadth Requirements. 63

CSULB (ITEP) Elementary Program and CSUF (STEP) Elementary Program 31

Cultural Clubs 39

Cultural Diversity 57

Cypress College Biology Majors Course Sequence 119

Cypress College Institutional Learning Outcomes 5

Cypress College Transcripts 24

Cypress College Vision Statement 4

D

Dance 154

Dean’s List. 10

Dental Assisting 158

Dental Hygiene 161

Department Certificates. 50

Departmental/Area Majors 62

Description of Courses. 70

Diagnostic Medical Sonography 164

Disability Support Services (DSS). 34

Disabled Veterans 38

Discipline Procedures 42

Distance Education Program 26

Dress Code 39

E

Economics 167

Education 169

Energy Sustainable Technology 171

Engineering 173

Engineering Technology 175

English 175

English as a Second Language 26, 181

Enrollment Fees. 8

Enrollment Limitation. 23

Ethnic Studies 183

Examinations. 16

Extended Opportunity Programs and Services (EOPS). 35

External Exam Credit 16

F

F-2 Dependents. 29

Faculty. 317

Family Educational Rights and Privacy Act 47

Fees 8

FERPA 47

Financial Aid 35

Food Services — Campus Dining 36

Foreign Language 186

Foundation. 36

French. 187

G

General Education Certification (GE) and Pass Along. 70

General Education (Native) Requirements for the Associate Degree. 54

Geography 188

Geology 191

Grade Change 19

Grade Reports 19

Grades and Grade Point Average 19

Grading System 19

Graduation Requirements for an Associate Degree. 57

Grounds for Challenge 12

Guardian Scholars 36

H

Health Fee 8

Health Information Technology 193

Health Science. 197

Health Science — Continuing Education 198

Health Services 36

High School Transcripts 24

History. 198

Honors at Entrance 10

| | |
|---|-----|
| Honors at Graduation | 11 |
| Honors Program | 28 |
| Hotel, Restaurant, Culinary Arts | 202 |
| How To Earn an Occupational Certificate | 48 |
| How To Earn an Associate Degree | 51 |
| How To Transfer to a Four-Year College | 57 |
| Human Services | 207 |
| Hybrid Courses | 26 |

I

| | |
|--|-----|
| IB (International Baccalaureate) Examination Credit | 21 |
| Industrial Education Teaching | 212 |
| Institutional Learning Outcomes | 4 |
| Instructional Divisions | 311 |
| Instructional Support Services | 26 |
| Inter-Club Council (ICC) | 40 |
| Intercollegiate Athletic Program | 39 |
| Interdisciplinary Studies | 213 |
| International Baccalaureate (IB) | 19 |
| International Students | 29 |
| International Transcript Evaluations | 21 |
| Intersegmental General Education Transfer Curriculum (IGETC) | 67 |

J

| | |
|-------------------------------------|-----|
| Japanese | 214 |
| Journalism/Communications | 215 |

K

| | |
|-------------------------------------|-----|
| Kinesiology (formerly PE) | 217 |
|-------------------------------------|-----|

L

| | |
|--|-----|
| Latin American Studies | 228 |
| Legacy Program | 29 |
| Liberal Arts Degree with a Specified Department/Area Major | 63 |
| Liberal Arts Degree with Area of Emphasis | 58 |
| Liberal Studies | 229 |
| Library | 229 |
| Library and Learning Resource Center | 27 |
| Lost and Found | 37 |

M

| | |
|-----------------------------|---------|
| Management | 229 |
| Marketing | 235 |
| Mathematics | 23, 239 |
| Media Arts Design | 244 |
| Merchandising | 252 |

| | |
|--|-----|
| Mission Statement | 4 |
| Mortuary Science | 252 |
| Mortuary Science Baccalaureate | 257 |
| Multimedia | 258 |
| Music | 259 |
| myGateway | 8 |

N

| | |
|--|-----|
| New Students | 7 |
| Non-Collegiate Instruction | 16 |
| Non-Degree Credit Courses (Basic Skills) | 21 |
| Non-Discrimination Statement | 46 |
| Non-Resident Tuition | 8 |
| Nursing Program | 266 |

O

| | |
|---|----|
| Occupational Certificate Requirements | 48 |
| Occupational Degree | 52 |
| Official Student Publications | 40 |
| Online Courses | 26 |
| Open Enrollment Policy | 7 |
| Open-Entry Courses | 25 |

P

| | |
|--|-------|
| Parking | 8, 33 |
| Parking Enforcement and Appeals | 34 |
| Pass/No Pass Grading | 20 |
| Pathway I: Associate Degree and/or CSU/IGETC Transfer Curriculum | 5 |
| Pathway II: Career and Technical Education Certification | 5 |
| Pathway III: Personal, Academic, and Professional Development | 6 |
| Patrons of the Arts | 37 |
| Petitions and Appeals | 21 |
| Philosophy and Religious Studies | 247 |
| Photography | 277 |
| Physical Education (see Kinesiology) | 217 |
| Physical Science | 282 |
| Physics | 282 |
| Political Science | 284 |
| Portuguese | 286 |
| Pre-Collegiate Basic Skills Courses | 23 |
| Pre-Professional Programs | 287 |
| Prerequisite | 71 |
| President's List | 10 |
| Privacy Release | 24 |
| Probation and Dismissal Policies | 22 |

| | | | |
|---|--------|---|--------|
| Procedures | 41, 42 | Student Housing | 37 |
| Procedures During Registration | 23 | Student Representation Fee | 9 |
| Professors Emeritus | 325 | Student Responsibility | 12 |
| Proficiency Examination | 22 | Student Right to Know Campus Security Act | 47 |
| Programs of Study | 48 | Student Rights and Responsibilities | 45 |
| Psychiatric Technology | 287 | Student Rights under FERPA for Postsecondary Institutions | 47 |
| Psychology | 289 | Student Success and Support Program | 37 |
| Publications | 40 | Student Support Services | 32 |
| Puente Program | 30 | Study Abroad Program | 31 |
| R | | Study Load | 24 |
| Radiologic Technology | 292 | Summer Intersession Courses | 25 |
| Reading | 22 | Supplemental Instruction | 27 |
| Reading Proficiency | 57 | T | |
| Readmission After Scholastic Dismissal | 22 | Teacher Preparation Program | 31 |
| Recreation | 297 | Teaching Credential Preparation | 31 |
| Refund Processing Fee | 9 | Theater Arts | 301 |
| Refunds | 9 | Title IX and Civil Rights Grievances | 46 |
| Registration | 7 | Transcript Fees | 9 |
| Release of Student Information | 23 | Transcripts | 24, 39 |
| Remedial Limitation | 23 | Transfer Alliances | 28 |
| Repeated Classes | 39 | Transfer Center | 37 |
| Residency | 6 | Transfer Credit — Baccalaureate Degrees | 71 |
| Returning Students | 7 | Transfer Programs | 57 |
| Review and Release of Student Information | 23 | U | |
| S | | Unit | 71 |
| Semester Courses | 25 | Unofficial Publications | 40 |
| Service Charge for Returned Checks | 9 | V | |
| Service Fees | 9 | Verification of Enrollment/Student Status | 9 |
| Service Learning | 30 | Veteran Dependent Exemption | 38 |
| Short Term Courses | 25 | Veterans Academic Progress | 39 |
| Social Sciences | 297 | Veterans and Service Members | 38 |
| Sociology | 298 | Veterans Military Service Connected Benefit Programs | 38 |
| Spanish | 300 | Victims of Sexual Assault | 47 |
| Special Admit Program | 30 | Vision Statement | 4 |
| Special Programs | 28 | W | |
| Standard Definitions | 70 | Weekend Seminars | 25 |
| Standards for Scholastic Dismissal | 22 | What is FERPA? | 47 |
| Student Activities | 40 | Withdrawal | 25 |
| Student Government | 40 | | |
| Student Grievances | 46 | | |

Notes

Notes

Notes